

**Civil & Sanitary Work Estimate For Construction of Public Toilet Block at Near Ashutosh Cold Store Ward no 8 within Tarakeswar Municipality**

G

No. Of seat - Male - ( W.C. -2 + Urinal -3) & Female - (W.C. -2 + Urinal -2) = **Total ( W.C. -4 & Urinal -5)**

Rate As per PWD Building Works Schedule ( Volume 1) With effect from 01.11.2017

Sl. No.	Item Description & Item No.							Quantity	Rate	Unit	Amount
	Details	Side	No.	L	B	H	QNTY.				
1	Earth work in excavation of foundation trenches or drains, in all sorts of soil (including mixed soil but excluding laterite or sandstone) including removing, spreading or stacking the spoils within a lead of 75 m. as directed. The item includes necessary trimming the sides of trenches, levelling, dressing and ramming the bottom, bailing out water as required complete. (a) Depth of excavation not exceeding 1,500 mm. PWD Building Works schedule Page - 1, Item -2.a							34.52	11927.00	%Cum	4117.20
	Column		9	1.500	1.5	1.1	22.280				
	Tie Beam		1	31.35	0.35	0.375	4.110				
	Reservior		1	2.5	2	1.625	8.130				
							34.520				
2	Single Brick Flat Soling of picked jhama bricks including ramming and dressing bed to proper level and filling joints with local sand. PWD Building Works schedule, Page- 14, Item - 1 ( Corri. Page-01, Date-04-06-2018)							62.61	357.00	Sqm	22351.77
	Column		9	1.500	1.5		20.250				
	Tie Beam		1	31.35	0.25		7.840				
	Parti beam		1	11.95	0.125		1.490				
	Floor		1	6.3	3.775		23.780				
	Platform		1	1.5	1		1.500				
	Ramp		1	2.75	1		2.750				
	Reservior		1	2.5	2		5.000				
						62.610					
3	Supplying and laying Polythene Sheet (150gm / sq.m.) over damp proof course or below flooring or roof terracing or in foundation or in foundation trenches. PWD Building Works schedule, Page -47, Item -3							29.583 <del>30.75</del>	24.00	Sqm	710.0 <del>738.00</del>
	Open Space		1	20	1.5		30.000				
	Front Stair		1	1.5	0.5		0.750				
						30.750					
4	Cement concrete with graded jhama khoa (30 mm size) excluding shuttering In ground floor and foundation. (a) 1:3:6 proportion. PWD Building Works schedule, Page -23, Item -B.1.a, ( Corri. Page-09, Date-04-06-2018) Rate Analysis							8.42	4783.42	Cum	40276.40
	Column		9	1.500	1.5	0.1	2.030				
	Floor		1	6.3	3.775	0.1	2.380				
	Platform		1	1.5	1	0.1	0.150				
	Ramp		1	2.75	1	0.1	0.280				
	Reservior		1	2.5	2	0.1	0.500				
	Open Space		1	20	1.5	0.1	3.000				
	Front Stair		1	1.5	0.5	0.1	0.080				
						8.420					

5	25mm. thick damp proof course with cement concrete with stone chips (1:1.5:3) [with graded stone aggregate 10 mm nominal size] and admixture of water proofing compound as per manufacturer's specification followed by two coat of polymer based paint, (1st coat after 4 to 5 days of concrete laying and 2 nd coat just before brick masonry work) as directed (cost of water proofing compound & polymer based paint to be paid separately). (Chequering not required over concrete or painted surface). [Note: Waterproofing as per item 9, polymer based paint as per item 8 (a) of subhead C of Section (C). PWD Building Works schedule, Page -47, Item -1 (Rate Analysis)						8.25	184.11	Sqm	1518.91
		1	19.7	0.25		4.930				
		1	26.55	0.125		3.320				
						8.250				
6	Brick work with 1st class bricks in cement mortar (1:4) (a) In foundation and plinth PWD Building Works schedule, Page -15, Item-7.a (Rate Analysis)						7.24	5246.67	Cum	37985.89
	GL 2 PL	1	31.35	0.250	0.450	3.530				
	Ramp	1	2.75	0.250	0.225	0.150				
	Platform	1	3.5	0.250	0.450	0.390				
	Front Stair	1	1.5	0.25	0.3	0.110				
		1	1.5	0.25	0.15	0.060				
	Reservior	1	8	0.25	1.5	3.000				
						7.240				
7	Brick work with 1st class bricks in cement mortar (1:4) (b) In superstructure, ground floor PWD Building Works schedule, Page -15, Item-7.b (Rate Analysis)						12.08	5468.67	Cum	66061.53
	Outer Wall	1	20.9	0.25	2.575	13.450				
	Less Door	-1	1.2	0.25	2.1	-0.630				
	Less Window	-11	0.6	0.25	0.45	-0.740				
						12.080				
8	125 mm. thick brick work with 1st class bricks in cement mortar (1:4) in ground floor. PWD Building Works schedule, Page - 16, Item - 16 ( Corri. Page-03, Date-04-06-2018) (Rate Analysis)						59.37	714.46	Sqm	42417.49
	Wall	1	8.55		2.75	23.510				
	Less Door	-2	0.75		2.1	-3.150				
		1	21.575		1.95	42.070				
	Less Door	-1	8.5		1.95	-16.580				
	Spring	1	23.900		0.125	2.990				
	Parapet	1	23.400		0.45	10.530				
						59.370				
9	Earth work in filling in foundation trenches or plinth with good earth, in layers not exceeding 150 mm. including watering and ramming etc. layer by layer complete. (Payment to be made on the basis of measurement of finished quantity of work). (a) With earth obtained from excavation of foundation. PWD Building Works schedule, Page - 1, Item -3.a						22.78	7754.00	%Cum	1766.36
	2/3rd of Earth work		0.66	34.52		22.78				
10	(A) Filling in foundation or plinth by silver sand in layers not exceeding 150 mm as directed and consolidating the same by thorough saturation with water, ramming complete including the cost of supply of sand. (payment to be made on measurement of finished quantity) PWD Building Works schedule, Page - 2, Item -4.a						12.30	71181.00	%Cum	8755.26

		1	6.55	3.9	0.45	11.5					
Ramp		1	2.75	0.75	0.225	0.46					
Platform		1	1	0.75	0.45	0.34					
						12.30					
11	Hire and labour charges for shuttering with centering and necessary staging upto 4 m using approved stout props and thick hard wood planks of approved thickness with required bracing for concrete slabs, beams and columns, lintels curved or straight including fitting, fixing and striking out after completion of works (upto roof of ground floor) (f) 25 mm to 30 mm shuttering without staging in foundation PWD Building Works schedule, Page -42, Item- 36.f						39.63	209.00	Sqm	8282.67	
Foundation		36	1.20		0.15	6.48					
Tie Beam		2	31.35		0.3	18.81					
Parti beam		2	11.95		0.25	5.98					
Coumn		36	0.3		0.725	7.83					
Ramp		1	2.75		0.1	0.28					
Platform		1	2.5		0.1	0.25					
						39.630					
12	Hire and labour charges for shuttering with centering and necessary staging upto 4 m using approved stout props and thick hard wood planks of approved thickness with required bracing for concrete slabs, beams and columns, lintels curved or straight including fitting, fixing and striking out after completion of works (upto roof of ground floor) (a) 25 mm to 30 mm thick wooden shuttering as per decision & direction of Engineer-In-Charge. PWD Building Works schedule, Page -42, Item- 36.a						105.09	334.00	Sqm	35100.06	
Coumn		36	0.25		2.575	23.180					
Roof Beam		1	23.9		0.3	7.170					
Roof Beam		1	47.8		0.175	8.370					
Lintel		2	12.300		0.2	4.920					
Lintel btm		1	8.400		0.25	2.100					
Lintel		2	30.250		0.2	12.100					
Lintel btm		1	8.25		0.125	1.030					
Chajja		1	12.300	0.3		3.690					
		1	20.100		0.075	1.510					
slab with b btm		1	7.300	4.65		33.950					
Slab Side		1	23.900		0.125	2.990					
Reservior		1	2	1.5		3.000					
		1	9		0.12	1.080					
						105.090					
13	Ordinary Cement concrete (mix 1:1.5:3) with graded stone chips (20 mm nominal size) excluding shuttering and reinforcement, if any, in ground floor as per relevant IS codes. a) Pakur Variety /Chandil Variety PWD Building Works schedule, p-26 Item 10 a (Rate Analysis)						14.3291 <del>15.78</del>	5468.54 <del>4965.73</del>	Cum	78359.22	
Colm foot		9	1.2	1.2	0.15	1.940					
						$9*0.15/3*(1*1+0.3*0.3+1*0.3)=.6255$			0.630		
Tool Column		9	0.3	0.3	0.425	0.340					
Column		9	0.25	0.25	3.025	1.700					
Tie Beam		1	31.35	0.25	0.3	2.350					
Parti beam		1	11.95	0.25	0.25	0.750					
Lintel		1	30.250	0.125	0.2	0.760					
		1	12.300	0.25	0.2	0.620					
Chajja		1	12.300	0.3	0.075	0.280					
Slab Beam		1	33.6	0.25	0.175	1.470					
Slab		1	7.300	4.65	0.125	4.240					

Wash Basin		2	0.750	0.6	0.075	0.070				
Reservior		1	2.5	2	0.125	0.630				
						15.780				

14 Reinforcement for reinforced concrete work in all sorts of structures including distribution bars, stirrups, binders etc initial straightening and removal of loose rust (if necessary), cutting to requisite length, hooking and bending to correct shape, placing in proper position and binding with 16 gauge black annealed wire at every intersection, complete as per drawing and direction. (a) For works in foundation and upto roof of ground floor/upto 4 m. (i) Tor steel/Mild Steel , JSPL/SWAYN/ELETRO/STEEL  
 PWD Building Works schedule, Page - 43, Item - 40.a.i.1( Corri. 10th Page-01, Date-23-01-2020) (Rate Analysis)

1.710 54400.74 M.T. 93025.27

Footing	9	16	0.95	0.617	0.001	0.084				
Column	9	4	4.175	0.89	0.001	0.134				
Stirup	9	24	0.850	0.39	0.001	0.072				
Tie beam	3	5	7.55	1.56	0.001	0.177				
	3	5	4.9	1.56	0.001	0.115				
Stirup	1	209	1.05	0.39	0.001	0.086				
PLBeam	1	4	7.45	0.89	0.001	0.027				
	1	4	4.8	0.89	0.001	0.017				
	6	4	1.875	0.89	0.001	0.040				
Stirup	1	113	0.750	0.39	0.001	0.033				
Lintel	3	4	1.25	0.617	0.001	0.009				
	1	4	23.45	0.617	0.001	0.058				
	11	4	0.85	0.617	0.001	0.023				
	1	4	1.45	0.617	0.001	0.004				
Stirup	1	125	0.650	0.39	0.001	0.032				
	1	48	0.900	0.39	0.001	0.017				
Chajja	1	76	0.300	0.39	0.001	0.009				
	1	3	11.400	0.39	0.001	0.013				
Roof Beam	3	5	7.55	1.56	0.001	0.177				
	3	5	4.9	1.56	0.001	0.115				
Stirup	1	209	1.05	0.39	0.001	0.086				
Slab	2	48	4.6	0.39	0.001	0.172				
less l/3	-1	16	1.5	0.39	0.001	-0.009				
	2	27	7.25	0.39	0.001	0.153				
less l/3	-1	7	2.4	0.39	0.001	-0.007				
Wash Basin	2	6	0.75	0.39	0.001	0.004				
	2	4	0.75	0.39	0.001	0.002				
UGR	1	19	1.65	0.39	0.001	0.012				
	1	14	2.25	0.39	0.001	0.012				
Lapping	24	1	0.8	1.56	0.001	0.030				
Lapping	24	1	0.6	0.89	0.001	0.013				
						1.7100				

15 Artificial stone in floor, dado, staircase etc with cement concrete (1:2:4) with stone chips, laid in panels as directed with topping made with ordinary or white cement (as necessary) and marble dust in proportion (1:2) including smooth finishing and rounding off corners including raking out joints or roughening of concrete surface and application of cement slurry before flooring.....  
 25 mm. thick  
 For roofing  
 PWD Building Works schedule, P-48, It-6.ii (Rate Analysis)

30.841 312.95  
 31.02 311.14 Sqm 9651.56

roof		1	7.05	4.4		31.020				
						31.020				

16	Neat cement punning about 1.5mm thick in wall, dado, window sill, floor etc. NOTE:Cement 0.152 cu.m per100 sq.m. PWD Building Works schedule, P-192, It. No. 15 (Rate Analysis)	25.92	32.75	Sqm	848.88
	Below Plinth	1	7.300	0.45	3.290
	Reservior	1	7	1.5	10.500
		1	2.5	2	5.000
		2	2	1.5	6.000
		1	9	0.125	1.130
					25.920
17	Labour for Chipping of concrete surface before taking up Plastering work. PWD Building Works schedule, P-192, It-1	105.09	21.00	Sqm	2206.89
	Same as shuttering sl no. 12	105.09			
18	Plaster (to wall, floor, ceiling etc.) with sand and cement mortar including rounding off or chamfering corners as directed and raking out joints including throating, nosing and drip course, scaffolding/staging where necessary (Ground floor).[Excluding cost of chipping over concrete surface] (i) With 1:6 cement mortar (c) 15 mm thick plaster PWD Building Works schedule, P-189 It- No. 1 (Rate Analysis)	182.06	141.52	Sqm	25765.13
	Back side	1	7.300	2.875	20.990
	Outer wall	1	16.600	0.775	12.870
	Chajja	1	11.400	0.925	10.550
	Chajja Side	24	0.300	0.075	0.540
	Iner Wall	1	44	0.775	34.100
	Spring	1	155.3	0.325	50.470
	Parapet wall	1	24.4	0.975	23.790
	Reservior	1	7	1.5	10.500
		2	2.5	2	10.000
		2	2	1.5	6.000
		1	9	0.25	2.250
					182.060
19	Plaster (to wall, floor, ceiling etc.) with sand and cement mortar including rounding off or chamfering corners as directed and raking out joints including throating, nosing and drip course, scaffolding/staging where necessary (Ground floor).[Excluding cost of chipping over concrete surface] (ii) With 1:4 cement mortar (c) 10 mm thick plaster PWD Building Works schedule, P-189 It- No. 1 (ii)(c) (Rate Analysis)	33.95	126.53	Sqm	4295.69
	Slab bottom	1	7.3	4.65	33.950
20	Supplying, fitting and fixing fibre reinforced polymer (FRP) Composite door frame as per approved section with glass fibre reinforced plastic moulded skins and a special sandwich core, so as to impart monolitaheic composite structure as per approved technology of Department of Science and Technology (DST) to safisfy IS: 4020 door testing performance criteria.. (i) 66mm x 90mm PWD Building Works schedule, P-115, It - 3 (i)	49.00	497.00	Mtr	24353.00
		8	4.65		37.200
		2	5.9		11.800
					49.000

21	Supplying, fitting & fixing fibre reinforced polymer (FRP) Composite door shutters as per approved design with glass fibre reinforced plastic moulded skins and a special sandwich core, so as to impart monolithic composite structure as per approved technology of Department of Science and Technology (DST) to satisfy IS:4020 door testing performance criteria. In ground floor. ii) 25 mm thick P-125, It- 14(ii)					13.00	2581.00	Sqm	33553.00
		8	1.884	0.65		9.800			
		2	1.88	0.85		3.200			
						13.000			
22	Anodised aluminium barrel / tower / socket bolt (full covered) of approved manufactured from extruded section conforming to I.S. 204/74 fitted and fixed with cadmium plated screws . (vii) 225mm long x 10mm dia. bolt. PWD Building Works schedule, P-144, It No. 26 (vii)					10.00	84.00	Each	840.00
		10	1.00			10.000			
23	Iron butt hinges of approved quality fitted and fixed with steel screws, with ISI mark. (viii) 100mm X 75mm X 3.50mm. PWD Building Works schedule, P-140, It No. -5 (viii)					30.00	66.00	Each	1980.00
		10	3.00			30.000			
24	Anodised aluminium decorative handle (hexagonal / fluted) of approved quality fitted and fixed complete. (i) 150mm plate x 10mm dia rod x 12mm hexagonal/fluted. PWD Building Works schedule, Page -146 . Item no-31,(i)					20.00	87.00	Each	1740.00
		10	2.00			20.000			
25	Iron hasp bolt of approved quality fitted and fixed complete (oxidised) with 16mm dia rod with concrete bolt and round fitting. .b)250mm long. PWD Building Works schedule, Page -141 . Item no-10 b)					10.00	159.00	Each	1590.00
		10	1.00			10.000			
26	(A) Supplying Aluminium casted body hydraulic door closer as per I.S.I. SOR, PWD, P- 244, I - 13(a)					10.00	635.00	Each	6350.00
		10	1.00			10.000			
27	Rendering the Surface of walls and ceiling with White Cement base WATER PROOF wall putty of approved make & brand.(1.5 mm thick) In Ground Floor PWD Building Works schedule, PWD, P- 198, I - 5					212.72	122.00	Sqm	25951.84
	Same as Plaster Item - Plinth plaster					212.72			
28	(b) Priming one coat on timber or plastered surface with synthetic oil bound primer of approved quality including smoothening surfaces by sand papering etc. PWD Building Works schedule, Page -200 . Item no- 1 (b)					212.72	38.00	Sqm	8083.36
	Same as Plaster Item - Plinth plaster					212.72			
29	(A) Painting with best quality synthetic enamel paint of approved make and brand including smoothening surface by sand papering etc. including using of approved putty etc. on the surface, if necessary : Page - 200 . Item no- 1 (b)					212.72	81.00	Sqm	17230.32
	(a) On timber or plastered surface : With super gloss (hi-gloss) - (iv) Two coats (with any shade except white) PWD Building Works schedule, Page -200 . Item no- 2(A)(a)(iv)								

	Same as Plaster Item - Plinth plaster			212.72					
30	Collapsible gate with 40mm x 40mm x 6mm Tee as top and bottom guide rail, 20mm x 10mm x 2mm vertical channels 100mm apart in fully stretched position 20mm x 5mm M.S. flats as collapsible bracings properly rivetted and washered including 38mm steel rollers including locking arrangements, fitted and fixed in position with lugs set in cement concrete and including cutting necessary holes, chasing etc. in walls, floors etc. and making good damages complete. In ground floor. P-106 Item-18 (3rd Corrigendam Page No 92)					4.47	4330.00	Sqm	19355.10
	gate	1	1.20		2.10	2.52			
		1	1		1.95	1.95			
						4.470			
31	(a) M.S.or W.I. Ornamental grill of approved design joints continuously welded with M.S, W.I. Flats and bars of windows, railing etc. fitted and fixed with necessary screws and lugs in ground floor.. (i) Grill weighing above 10 Kg./sq.mtr and up to 16 Kg./sq. mtr. PWD Building Works schedule, P-104 Item-13 A (i) (3rd Corrigendam Page No 91)					3.79	9888.00	Qntl	37475.52
	Grill	11	0.60	0.45	0.16	0.480			
	Boundary Partition	1	21.00	0.9	0.16	3.020			
	Box for pump	5	0.60	0.6	0.16	0.290			
						3.790			
32	(ii) Grill weighing above 16 Kg./sq.mtr and above PWD Building Works schedule, P-104 Item-13 A (ii) (3rd Corrigendam Page No 91)					1.28	9696.00	Qntl	12410.88
	Railing	1	4.75	0.9	0.30	1.280			
33	a) Priming one coat on steel or other metal surface with synthetic oil bound primer of approved quality including smoothening surfaces by sand papering etc. PWD Building Works schedule, P/200 Item-1(a)					64.83	29.00	Sqm	1880.07
	gate	2	1	1.20	2.10	5.040			
		2	1	1	1.95	3.900			
	Grill	2	11	0.60	0.45	5.940			
	Boundary Pa	2	1	21.00	0.9	37.800			
	Box for pump	2	5	0.60	0.6	3.600			
	Railing	2	1	4.75	0.9	8.550			
						64.830			
34	(A) Painting with best quality synthetic enamel paint of approved make and brand including smoothening surface by sand papering etc. including using of approved putty etc. on the surface, if necessary : (b) On steel or other metal surface : (iv) Two coats (with any shade except white) PWD Building Works schedule, P-200 Item-2(b)(iv)					64.83	79.00	Sqm	5121.57
	Same as primeing on grill				64.83				
35	Supplying and laying true to line and level vitrified tiles of approved brand (size not less than 600 mm X 600 mm X 10 mm thick) in floor, ..... With application slurry @1.75 kg/ Sq.m, 20 mm sand cement mortar (1:4) & 2 mm thick cement slurry at back side of tiles, 0.2 kg/ Sq.m white cement for joint filling with pigment. (A) Deep Colour & White PWD Building Works schedule, Page-66 Item-36 (A) ( 3rd Corrigendam , Page -36)					<del>29.18</del> 29.059	<del>1688.00</del> 1695.0	Sqm	49255.84

	floor		1	6.8	4.15		28.220				
	Door Gap		7	0.75	0.125		0.660				
			1	1.2	0.25		0.300				
							29.180				
36	<p>Supplying, fitting &amp; fixing 1st quality Ceramic tiles in walls and floors to match with the existing work &amp; 4 nos. of key stones (10mm) fixed with araldite at the back of each tile &amp; finishing the joints with white cement mixed with colouring oxide if required to match the colour of tiles including roughening of concrete surface, if necessary or by synthetic adhesive &amp; grout materials etc.</p> <p>B) Wall</p> <p>Area of each tile above 0.09 Sq.m</p> <p>ii) Other than Coloured decorative including white</p> <p>PWD Building Works schedule, page-64, Item:35.(B.) (b).(ii)</p> <p>(3rd Corrigendam ,Page 36)</p>						b)	159.66	1041.00	Sqm	166206.06
	Out side		1	16.6	2.1		34.860				
	Less Door		-1	1.2	2.1		-2.520				
	Door frame side		1	5.2	0.175		0.910				
	Inner		1	68.45	2.1		143.750				
	Less Door		-7	0.75	1.95		-10.240				
			-1	1.2	2.1		-2.520				
			-3	1	2.1		-6.300				
	Door frame side		1	9.85	0.175		1.720				
							159.660				
37	<p>a) 25 mm thick Tiles as per IS: 1237-2012 for footpath,ramp,staircase of public building(over 25 mm thick (Avg) Cement mortar (1:3) &amp; Cement Slurry @ 4.4 kg/Sq.m at back side of Block. Cement for Mortar &amp; Slurry to be supplied by Department). (ii) Coloured Decorative</p> <p>PWD Building Works schedule, page-74, Item:48(a)-ii ( 3rd Corrigendam ,Page 37)</p>							36.30	880.00	Sqm	31944.00
	Open Space		1	20	1.5		30.000				
	Ramp		1	2.75	1		2.750				
			1	2.75	0.225		0.620				
	Platform		1	1.5	1		1.500				
	Stair		1	1.5	0.95		1.430				
							36.300				
38	<p>Supplying, fitting &amp; fixing granite slabs 15mm to 18 mm. thick with uniform texture &amp; without decorative veins i ..... cost of all materials, labours, scaffolding, staging, curing and roughening of concrete surface complete.</p> <p>[Using cement slurry at back side of granite @ 4.4 kg/sq.m &amp; white cement slurry for joint filling @ 1.8 kg/sq.m]</p> <p>In ground floor</p> <p>(a) Area of each Granite slab 0.6 to 1.0 Square meter.</p> <p>PWD Building Works schedule, page-63, Item:33(a)- ( 3rd Corrigendam ,Page 37)</p>							1.348 <del>1.35</del>	3334.0 <del>3329.00</del>	Sqm	4494.15
	For Wash Basin		2	0.9	0.75		1.350				
39	<p>Supplying, fitting and fixing 18 mm thick marble partition slab with chawk doongri marbel square cut, both sides polished with two front corners rounded and edges polished.</p> <p>Sanitary and plumbing work schedule P-81, It-13</p>							0.72	1426.00	Sqm	1026.72
			1	1.2		0.6	0.72				

40	Supplying profiles of required section made of Aluminium Alloy Extrusions conforming to IS: 732-1983 and IS: 1285- 1975; Anodized (with required film thickness and specified colour / natural) matt finished conforming to IS: 1868-1983 for fabrication of composite door, sliding & casement windows, partitions, formed of basic sections of any ISI embossed / certified make and brand as per direction of Engineer - In- Charge. (Payment will be made on finished length of the work). (A) In 10-12 Micron thickness Anodizing film Natural white h) Louvered window. Top, bottom and side member. PWD Building Works schedule, PWD, P-233, I- 1(h) i	23.10	183.00	M	4227.30
		11	2.1		23.100
41	ii) Louvered Section.	19.80	658.00	M	13028.40
		33	0.6		19.800
42	iii) Cleat angle ( Non-anodized).	17.82	263.00	M	4686.66
		33	0.54		17.8200
43	Labour charge for fabrication and installation of composite door, window, partitions made from anodized extruded alloy aluminium sections ..... incidental charges, adhesive, joineries such as screw, cleat angle etc. but excluding the cost of extruded aluminium sections, glass, neoprene / EPDM gasket, locking arrangement and rollers. v ) Louvered window. PWD Building Works schedule SOR, PWD, P-239, I- 2 (v)	2.97	730.00	Sqm	2168.10
		11	0.6	0.45	2.970
44	Supplying bubble free float glass of approved make and brand conforming to IS: 2835-1987. iv) 5mm thick coloured / tinted / smoke glass. PWD Building Works schedule, P-243, I -9	2.97	585.00	Sq.M.	1737.45
		11	0.6	0.45	2.970
45	Painting block letters or digits in Black Japan or any approved paint as per direction. e) Size above 7.5 cm. and upto 10 cm. PWD Building Works schedule, P-268, It-17(e)	650.00	12.00	Each	7800.00
46	Supply and Fixing of 2 mm Polyvinyl glow sign board made of 22 SWG GI sheet box with 1"X1" aluminum channel for fixing the vinyl board after necessary cutting the letter as required & s\ f LED tube light fittings along with all accessories UDMA Electrical shdule P-14, It NO. 4	15.00	495.00	Sq.F.	7425.00
		1	5	3	15
47	Supplying and Planting of different plant / trees ( Supplying well grown plants bushy and healthy, minimum height as specified i.e. exposed height including all leads & lift, carriage, handling, manuring, applying presticide and fertilizer etc. i) Furcaria veriegated 10-12 leaves in height 20-30cm in arthen pots of size 25cm. PWD Building Works schedule, Page -261, It- 9 (i)	12	162.00	Each	1944.00
48	x) Ficus blakii (F. Vivicon) well branched (Bushy) of height 120cm - 135 cm in earthen pot of size 30cm. PWD Building Works schedule, Page -261, It- 9 (x)	9	187.00	Each	1683.00

49	xxvi) Areca Palm 4 - 5 suckers of height 90 cm to 105 cm in earthen pots of size 25 cm. PWD Building Works schedule, Page -261, It- 9 (xxvi)	6	127.00	Each	762.00 ✓
50	Supplying, fitting and fixing Anglo-Indian W.C. in white glazed vitreous china ware of approved make complete in position with necessary bolts, nuts etc. a) With 'P' trap (with vent) PWD S&P Schedule, page-79, item no -3 (a)	3	3104.00	Each	9312.00 ✓
51	Supplying, fitting and fixing Closet seat of approved make with lid and C.P. hinges, rubber buffer and brass screws complete .(b) Anglo Indian (i) Plastic (hallow type) White PWD S&P Schedule, page-81,item no 10.b.i	3	485.00	Each	1455.00 ✓
52	Supplying, fitting and fixing Shallow water closet Indian pattern (I.P.W.C.) of approved make in white vitreous chinaware in position (excluding cost of concrete for fixing). (i) 580 mm long PWD S&P Schedule, page-79,item no -1 (i)	1	<del>945.00</del> 973.0	Each	<del>945.00</del> 973.0
53	Supplying, fitting and fixing Flat back urinal (half stall urinal) in white vitreous chinaware of approved make in position with brass screws on 75 mm X 75 mm X 75 mm wooden blocks complete (ii) 470 mm X 280 mm X 340 mm PWD S&P Schedule, page.80,item no-6/(ii)	2	945.00	Each	1890.00 ✓
54	Supplying, fitting and fixing Squating plate with integral flushing in white vitreous chinaware of approved make in cement concrete (6:3:1) with jhama chips complete. (Payment of concrete will be paid seperately). (i) 450 mm X 350 mm PWD S&P Schedule, (P - 80, Item. No. - 7 ,	1	881.00	Each	881.00 ✓
55	Supplying, fitting and fixing 10 litre P.V.C. low-down cistern conforming to I.S. specification with P.V.C. fittings complete,C.I. brackets including two coats of painting to bracket etc. PWD S&P Schedule, Page No.-36 Item No.-2,	4	1015.00	Nos	4060.00 ✓
56	Supplying,fitting and fixing 32 mm dia. Flush Pipe of approved make with necessary fixing materials and clamps complete. i) Polythene Flush Pipe PWD S&P Schedule, Page no 81. Item no. 11(i)	4	155.00	Each	620.00 ✓
57	Supplying, fitting and fixing urinal flush pipe fittings of approved brand. (a) C.P. urinal flush pipe fittings range of one PWD S&P Schedule, S.P.81,item-12/a	3	414.00	Each	1242.00 ✓
58	Supplying, fitting and fixing white vitreous china best quality approved make wash basin with C.I. brackets on 75 mm X 75 mm wooden blocks, C.P. waste fittings of 32 mm dia., mending good all damages and painting the brackets with two coats of approved paint. (ii) 550 mm X 400 mm size PWD S&P Schedule, P-41, It 2 (ii)	2	2208.00	Each	4416.00 ✓
59	Supplying,fitting and fixing approved brand P.V.C. CONNECTOR white flexible, with both ends coupling with heavy brass C.P. nut, 15 mm dia., (iii) 600 mm long PWD S&P Schedule, Page No.-43 Item Nô.-9-iii PWD,	6	107.00	Each	642.00 ✓

60	Supplying,fitting and fixing approved brand 32 mm dia.P.V.C. waste pipe, with PVC coupling at one end fitted with necessary clamps. (iv) 1050 mm long each PWD S&P Schedule, Page No.-43 Item No. 10-iv	4	91.00	Each	364.00
61	(f) Hand Shower(Health Faucet) with 1mtr Flexible Tube with Wall Hook(Equivalent to Code No.573 & Model -ALLIED of Jaquar or similar). PWD S&P Schedule, Page No.-3 Item No.- 3 f,	3	1251.00	Each	3753.00
62	(a) (i) Chromium plated Bib Cock short body (Equivalent to Code No. 511 & Model - Tropical / Sumthing Special of ESSCO or similar brand). PWD S&P Schedule, Page No.-6 Item No.-7-a-i	7	539.00	Each	3773.00
63	(b) (i) Chromium plated Stop Cock (Equivalent to Code No. 513(A) & 513(B) & Model - Tropical / Sumthing Special of ESSCO or similar PWD S&P Schedule, Page No.-6 Item No.-7-b-i	5	493.00	Each	2465.00
64	Supplying, fitting and fixing shower of approved brand and make. (ii) Chromium plated round shower with revolving joint (Equivalent to Code No. 541(N) & Model - Tropical / Sumthing Special of ESSCO or similar brand). PWD S&P Schedule, Page No.-3 Item No.-3- a-ii	2	360.00	Each	720.00
65	(iii) Chromium plated shower arm 240 mm long (Equivalent to Code No. 536(A) & Model - Tropical / Sumthing Special of ESSCO or similar brand). Page No.-3 Item No.-3-a-(iii), PWD,VOL-II , 2017-18	2	309.00	Each	618.00
66	Chromium plated angular Stop Cock with wall flange (Equivalent to Code No. 5053 & Model - Florentine of Jaquar or similar brand). PWD S&P Schedule, Page No.-6 Item No.-7-d-i,	6	815.00	Each	4890.00
67	Supplying, fitting and fixing pillar cock of approved make. a) (i) CP Pillar Cock - 15 mm. (Equivalent to Code No. 507 & Model - Tropical / Sumthing Special of ESSCO or similar brand). (P. No. - 45, Item. No. - 19(a)i, Pwd Sanitary Plumbing Schedule 2017)	2	555.00	Each	1110.00
68	Supplying, fitting and fixing PVC pipes of approved make of Schedule 80 (medium duty) conforming to ASTM D - 1785 and threaded to match with GI Pipes as per IS : 1239 (Part - I). with all necessary accessories, specials viz. socket, bend, tee, union, cross, elbo, nipple, longscrew, reducing socket, reducing tee, short piece etc. fitted with holder bats clamps, including cutting pipes, making threads,fitting, fixing etc. complete in all respect including cost of all necessary fittings as required, jointing materials and two coats of painting with approved paint in any position above ground. (Payment will be made on the centre line measurements of total pipe line including all specials. No separate payment will be made for accesories, specials. Payment for painting will be made seperately) (a) For Exposed Work PVC Pipes, 25 mm Page No.-12 Item No.-19-i(a), PWD,VOL-II , 2017-18	25	177.00	Mtr	4425.00
69	(a) (a) For Exposed Work PVC Pipes, 15 mm Page No.-12 Item No.-19-i(a), PWD,VOL-II , 2017-18	15	101.00	Mtr	1515.00

70	(b) For Concealed Work PVC Pipes, 15 mm Page No.-12 Item No.-19-i(b), PWD,VOL-II , 2017-18	15	137.00	Mtr	2055.00
71	Supplying and fitting fixing of gunmetal wheel valve of approved brand and make tested to 21 Kg per sq. cm. 25 mm dia(E5) PWD S&P Schedule, P-5 It-5,vii),	2	778.00	Each	1556.00
72	Supplying P.V.C. water storage tank of approved quality with closed top with lid (Black) - Multilayer (b) 1000 litre capacity PWD S&P Schedule, page.37,item no-6 (b)	1	5128.00	Each	5128.00
73	Labour for hoisting plastic water storage tank. (i) Upto 1500 litre capacity. (a) Upto 1st story from G.L. PWD S&P Schedule, page.37,item no-10 (i)(a)	1	96.00	Each	96.00
74	Labour for punching hole in plastic water storage tank upto 50 mm dia. PWD S&P Schedule, (P. No. - 38, Item. No. - 13	2	19.00	Each	38.00
75	Supply of UPVC pipes (B Type) & fittings conforming to IS-13592-1992.(A) (i) Single Socketed 3 Meter Length, (b) 110 mm PWD S&P Schedule, Page No.-68 Item No. 23,(A)(i)(b)	24	292.00	Mtr	7008.00
76	(B) Fittings (i) Coupler, (b) 110 mm	12	85.00	Each	1020.00
77	(ii) Plain Tee, (b) 110 mm	12	85.00	Each	1020.00
78	(iii) Door Tee, (b) 110 mm	7	195.00	Each	1365.00
79	ix) Bend 45°, (b) 110 mm	7	89.00	Each	623.00
80	xi) Door Bend.(T.S.), (b) 110 mm	6	147.00	Each	882.00
81	xvi) Pipe Clip, (b) 110 mm	24	21.00	Each	504.00
82	xvii) W.C. Connector (150 mm long) 125 X 110(W/WC Ring) 75 mm	4	142.00	Each	568.00
83	xxxi) Plain Floor Trap with Top tile & Strainer 75 mm	3	144.00	Each	432.00
84	L) Rubber Ring, (b) 110 mm	24	17.00	Each	408.00
85	C)Rubber Lubricant 500 ML	3	187.00	500 ML	561.00
86	D)Solvent Cement 250 ML	3	103.00	250 ML	309.00
87	Labour for fitting and fixing U.P.V.C. pipes for above ground work including cost of jointing materials etc. fitting and fixing all necessary specials, cutting pipes, cutting holes in total pipeline including specials. (B) Under ground, (ii) 110 mm dia. PWD S&P Schedule, (P. - 74, Item. No. - 24 (B)	24	84.00	Mtr	2016.00

88	Supplying, fitting & fixing UPVC pipes A- Type and fittings conforming to IS:13592-1992 with all necessary clamps nails, including making holes in walls, floor etc. cutting trenches in any soil through masonry concrete structures etc if necessary and mending good damages including joining with jointing materials (Spun Yarn, Valamoid/Bitumen/M-Seal etc) complete. A) UPVC Pipes: (i) 75 mm. Dia. (P. - 212, Item. No. - 21 (A)(i) , (B),(c),(i) & (B), (d),(i), Pwd volume-i, 2017)	12	188.00	Mtr	2256.00
89	B) UPVC Fittings: c) Bend 87.5 degree (i) 75 mm. Dia.	4	95.00	Mtr	380.00
90	B) UPVC Fittings: d) Shoe (i) 75 mm. Dia.	4	78.00	Mtr	312.00
91	Constructing Inspection pit of inside measurement 600mm X 600mm X upto 600mm (depth) with 250 mm thick 1st. class brick work ..... complete in all respect with all costs of labour and materials. i) With Pakur variety (Other than SAIL/TATA/RINL). PWD S&P Schedule, S.P.87,Item No-1/(i), 7th Corrigenda Volume ii	4	7027.00	Each	28108.00
92	Construction of septic tank of different capacities as per approved drawing with 1st class brick work in cement mortar (1:4) including ..... with admixture of water proofing compound @ 0.5% by weight of cement with all costs of labour and materials. (iii) For 30 users A) With Pakur variety. (JSW/JSPL/SHYAM/SRMB/ELECTROSTEEL/SSL) PWD S&P Schedule, S.P.88,Item No-3(iii)(A) 7th Corrigenda Volume ii	1	61382.00	Each	61382.00
93	Construction of circular soak well 2.5 metre deep in all types of sandy soils with dry brick work upto 1.6 metre ..... as per direction complete in all respect with all costs of labour and materials. With 250 mm thick dry brick work and 250 mm thick cement brick work (1:6) and 1.00m inside dia. (Other than SAIL/TATA/RINL) S.P.89,Item No-4 7th Corrigenda Volume ii	1	16381.00	Each	16381.00
94	Supplying, fitting and fixing towel rail with two brackets. (a) C.P. over brass (ii) 25 mm dia. and 600 mm long S&P Schedule, p No 82 I No- 22 (a)(ii)	8	430.00	Each	3440.00
95	Supplying, fitting and fixing cast iron raised rain proof tank cover 500 mm dia. with locking arrangements (weighing not less than 12 kg). PWD S&P Schedule, . page-37,item no -8	1	1263.00	Each	1263.00
96	Supplying, fitting and fixing bevelled edged mirror 5.5 mm thick silver red as per I.S. 3438 / 1965 together with brass C.P. hinges. (ii) 600 mm X 450 mm PWD S&P Schedule, P-81, It-15(ii)	2	484.00	Each	968.00
97	Supplying, fitting and fixing soap holder. Fibre glass Sanitary and plumbing work schedule P-82, It-18(b)	9	58.00	Each	522.00
98	Supplying, fitting and fixing porcelain toilet paper holder of approved make with wooden spindle as necessary. (i) Roll type size 250 mm X 125 mm (A5) Sanitary & Plumbing works p No 83 I No- 23 gi)	6	293.00	Each	1758.00

99	Supplying, fitting and fixing glass shelf with aluminium guard rails. (a) Ordinary type with 5.5 mm sheet glass 450 mm X 125 mm Sanitary and plumbing work schedule P-81, It-16(a)(i)	(i)	8	341.00	Each	2728.00
Sub Total Of (A)						<b>1174011.52</b>
				Add S.G.S.T. @	9%	105661.04
				Add C.G.S.T. @	9%	105661.04
Cost Of Civil & Sanitary Work						<b>1385333.60</b>
				Add L.W.C. @	1%	13853.34
Total payable Amount Including L.W.C.						<b>1399186.94</b>
						Add Contingency @3%
						41560.01
Total payable Amount Including L.W.C. and contingency						<b>1440746.95</b>
						Say Rs.
						<b>1440747.00</b>
In Word ( Say ) : <b>Rupees Forteen Lakh Seventy Five Thousand Seven hundred Twenty Nine only</b>						

(Rupees fourteen Lakh forty thousand Seven hundred forty seven only)

14.10.25  
Sub Assistant Engineer  
Tarakeswar Municipality

*M. Chak*  
27/11/25  
Junior Engineer (Civil)  
Hooghly Division  
M.E. Directorate, Deptt. of U.D. & M.A.  
Govt. of West Bengal

*S. K. Das*  
02/12/25  
Assistant Engineer  
Hooghly Division, M.E. Dte  
Deptt. of U.D. & M.A.  
Govt. of West Bengal

*W. K.*  
CHAIRMAN  
TARAKESWAR MUNICIPALITY

*S. K. Das*  
05/12/25  
Executive Engineer  
Hooghly Division  
M.E. Directorate, Deptt. of U.D. & M.A.  
Govt. of West Bengal

# ASHUTOSH COLD STORE WARD NO 8

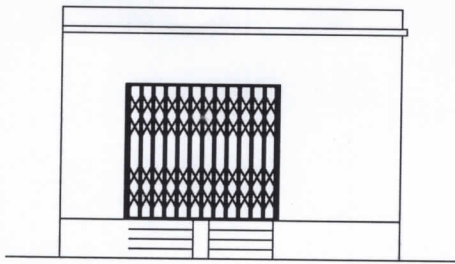

FRONT ELEVATION

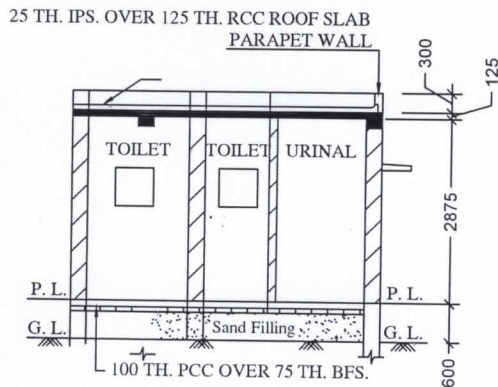

SECTION - 'A - A'

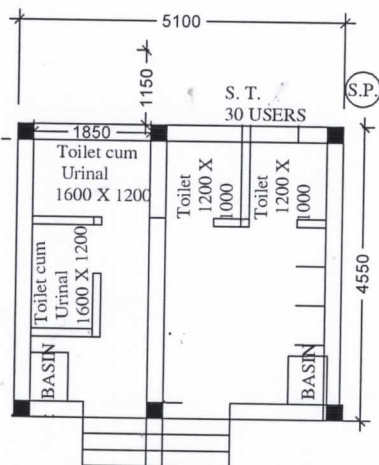

PLAN

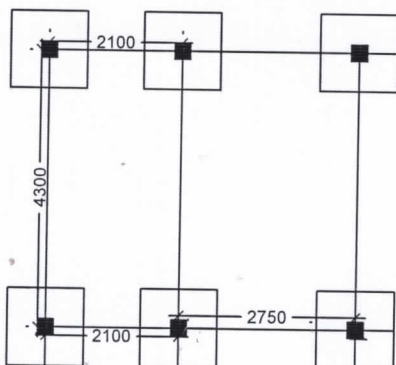

LAYOUT PLAN

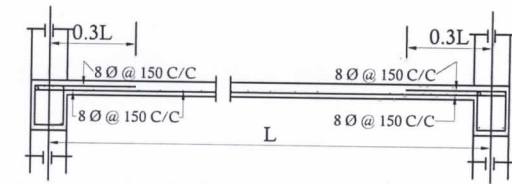
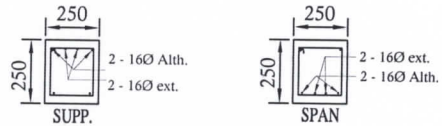

Details Of R.C.C Roof Slab & Beam

(SCALE - 1 : 25)

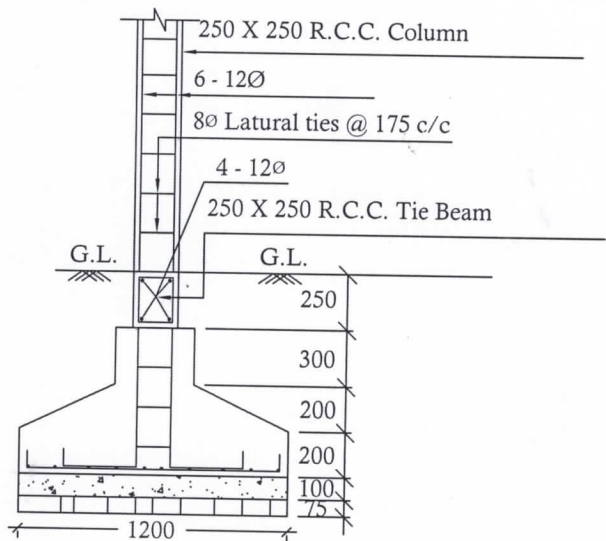

DETAILS OF R. C. C COLUMN

(SCALE - 1 : 25)

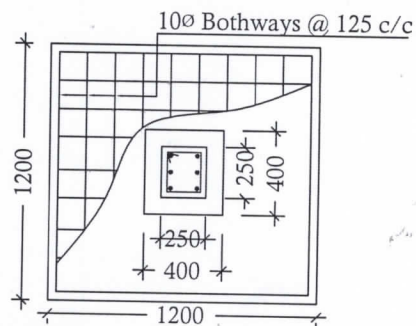

*Handwritten signature*  
 14.10.25  
 Sub Assistant Engineer  
 Tarakeswar Municipality

*Handwritten signature*  
 CHAIRMAN  
 TARAKESWAR MUNICIPALITY