

**PROBABLE ESTIMATE OF CONSTRUCTION OF TOILET BLOCK AT- KALDIGHI PARK IN WARD NO-18, UNDER
GANGARAMPUR MUNICIPALITY D/D.(CT/PT) MODEL NO - G CIVIL WORKS
TOILET SEATS -4 NOS AND URINAL- 5 NOS**

Rate as per PWD Building & Sanitary schedule 2017 on dt.-01.11.2017 & Latest Corrigendum

| SL.NO | Item Description & Item No. | Quantity | Rate | Unit | Ammount |
|-------|---|----------|--------|------|----------|
| 1 | Earth work in excavation of foundation trenches or drains, in all sorts of soil (including mixed soil but excluding laterite or sandstone) including removing, spreading or stacking the spoils within a lead of 75 m. as directed. The item includes necessary trimming the sides of trenches, levelling, dressing and ramming the bottom, bailing out water as required complete. (a) Depth of excavation not exceeding 1,500 mm. PWD Building Works schedule Page - 1, Item -2.a COLM. $3 \times 2 \times 1.20 \times 1.20 \times 1.00 = 8.64 \text{ M3}$ partition wall $1 \times 1.00 \times 0.375 \times 0.150 = 0.056 \text{ m3}$ | 8.696 | 119.27 | Cu.m | 1037.17 |
| 2 | Earth work in filling in foundation trenches or plinth with good earth, in layers not exceeding 150 mm. including watering and ramming etc. layer by layer complete. (Payment to be made on the basis of measurement of finished quantity of work). (a) With earth obtained from excavation of foundation. PWD Building Works schedule, Page - 1, Item -3.a | 8.696 | 77.54 | Cum | 674.29 |
| 3 | (A) Filling in foundation or plinth by silver sand in layers not exceeding 150 mm as directed and consolidating the same by thorough saturation with water, ramming complete including the cost of supply of sand. (payment to be made on measurement of finished quantity) PWD Building Works schedule, Page - 2, Item -4.a $1 \times 5.10 \times 4.55 \times 0.325 = 7.542 \text{ m3}$ | 7.542 | 487.41 | Cum | 3676.05 |
| 4 | Single Brick Flat Soling of picked jhama bricks including ramming and dressing bed to proper level and filling joints with local sand. PWD Building Works schedule, Page- 14, Item - 1 (Corri. Page-01, Date-04-06-2018) $3 \times 2 \times 1.20 \times 1.20 = 8.64 \text{ m2}$ $2 \times 2.50 \times 0.375 = 1.88 \text{ m2}$ $1 \times 1.00 \times 0.375 = 0.375 \text{ m2}$ $2 \times 1.50 \times 1.00 = 3.00 \text{ m2}$ $1 \times 5.10 \times 4.55 = 23.21 \text{ m2}$ | 37.10 | 322.00 | Sqm | 11946.20 |

| SL.NO | Item Description & Item No. | Quantity | Rate | Unit | Ammount |
|-------|---|----------|---------|----------------|----------|
| 5 | <p>Ordinary Cement concrete (mix 1:1.5:3) with graded stone chips (20 mm nominal size) excluding shuttering and reinforcement, if any, in ground floor as per relevant IS codes.</p> <p>a) Pakur Variety /Chandil Variety</p> <p>PWD Building Works schedule, p-26 Item 10 a (Rate Analysis)</p> <p>$2 \times 3 \times 1.20 \times 1.20 \times 0.150 = 1.296 \text{ m}^3$</p> <p>$2 \times 3 \times (1.20 \times 1.20) + (0.250 \times 0.250) / 2 \times 0.150 = 0.676 \text{ m}^3$</p> <p>$2 \times 3 \times 0.250 \times 0.250 \times 3.90 = 1.463 \text{ m}^3$</p> <p>$2 \times 2 \times 2.525 \times 0.250 \times 0.250 = 0.789 \text{ m}^3$</p> <p>$3 \times 3.00 \times 0.250 \times 0.250 = 0.563 \text{ m}^3$</p> <p>$2 \times 2 \times 2.525 \times 0.250 \times 0.150 = 0.379 \text{ m}^3$</p> <p>$3 \times 3.00 \times 0.250 \times 0.150 = 0.338 \text{ m}^3$</p> <p>$1 \times 5.10 \times 4.55 \times 0.1025 = 2.900 \text{ m}^3$</p> | 7.61 | 5844.33 | Cum | 44475.35 |
| 6 | <p>Cement concrete with graded jhama khoa (30 mm size) excluding shuttering in ground floor and foundation. (a) 1:3:6 proportion. PWD Building Works schedule, Page - 23, Item -B.1.a, (Corri. Page- 09, Date-04-06-2018) Rate Analysis1 (Corri. Page-01, Date-04-06-2018)</p> <p>$37.10 \times 0.100 = 3.71 \text{ M}^3$</p> | 3.710 | 5442.18 | m ³ | 20190.49 |
| 7 | <p>25mm. thick damp proof course with cement concrete with stone chips (1:1.5:3) [with graded stone aggregate 10 mm nominal size] and admixture of water proofing compound as per manufacturer's specification followed by two coat of polymer based paint, (1st coat after 4 to 5 days of concrete laying and 2 nd coat just before brick masonry work) as directed (cost of water proofing compound & polymer based paint to be paid separately).(Chequering not required over concrete or painted surface). [Note:</p> <p>- Waterproofing as per item 9, polymer based paint as per item 8</p> <p>(a) of subhead C of Section (C).</p> <p>PWD Building Works schedule, Page -47, Item -1 (Rate Analysis)</p> <p>$2 \times 5.10 \times 0.250 = 2.55 \text{ m}^2$</p> <p>$3 \times 4.55 \times 0.250 = 3.41 \text{ m}^2$</p> | 5.96 | 204.00 | Sqm | 1215.84 |
| 8 | <p>125 mm brick work with 1st classbricks in cement mortar (1:4) in ground floor.</p> <p>PWD Building Works schedule, Page -16, Item-16,cori page -3, date -04.06.2018 (Rate Analysis)</p> <p>$5 \times 1.20 \times 3.00 = 18.00 \text{ m}^2$</p> <p>$3 \times 1.00 \times 3.00 = 9.00 \text{ m}^2$</p> | 27.00 | 674.33 | Sq.M. | 18206.91 |
| 9 | <p>Supplying and laying polythine sheet (150 gm/sq.m) over dampproof course or below flooring or roof terracing or foundation or foundation trenches.</p> <p>PWD Building Works schedule, Page -47, Item-3</p> | 23.21 | 24.00 | Sq.M. | 557.04 |

| SL.NO | Item Description & Item No. | Quantity | Rate | Unit | Amount |
|-------|--|----------|----------|------|----------|
| 10 | Hire and labour charges for shuttering with centering and necessary staging upto 4 m using approved stout props and thick hard wood planks of approved thickness with required bracing for concrete slabs, beams and columns, lintels curved or straight including fitting, fixing and striking out after completion of works (upto roof of ground floor) (f) 25 mm to 30 mm shuttering without staging in foundation PWD Building Works schedule, Page -42, Item- 36.f $2 \times 2 \times 5.10 \times 0.250 = 5.10 \text{ m}^2$ $3 \times 2 \times 4.55 \times 0.25 = 6.83 \text{ m}^2$ $6 \times 4 \times 1.20 \times 0.150 = 4.32 \text{ m}^2$ | 16.25 | 205.00 | Sqm | 3331.25 |
| 11 | Hire and labour charges for shuttering with centering and necessary staging upto 4 m using approved stout props and thick hard wood planks of approved thickness with required bracing for concrete slabs, beams and columns, lintels curved or straight including fitting, fixing and striking out after completion of works (upto roof of ground floor) (a) 25 mm to 30 mm thick wooden shuttering as per decision & direction of Engineer-In-Charge. PWD Building Works schedule, Page -42, Item- 36.a $1 \times 5.10 \times 4.55 = 23.21 \text{ m}^2$ $2(5.10 + 4.55) \times 0.125 = 2.41 \text{ m}^2$ $6(.30+.025) \times 3.00 = 9.90 \text{ m}^2$ $2 \times 2 \times 5.1 \times 0.1250 = 3.825 \text{ m}^2$ $3 \times 2 \times 4.55 \times 0.125 = 3.41 \text{ m}^2$ | 42.75 | 328.00 | Sqm | 14022.00 |
| 12 | Artificial stone in floor ,dado,staircaseetc with cement mortar (1:2:4)with stone chips lsied in panels as directed with topping made with ordinary or white cement (as necessary) and marbel dust in proportion (1:2) in cluding smooth finishing and rounding off corners including raking out joints or roughening of concrete surface and application of cement slurry before flooring works using cement @ 1.75 kg/ sq.m all complete including all materials and labour. In ground floor 3 mm thick topping using gray cement (ii)25 mm PWD Building Works schedule, p-48 Item 6(ii) $5.10 \times 4.55 = 23.21 \text{ m}^2$ | 23.21 | 262.00 | Sq.m | 6081.02 |
| 13 | Reinforcement for reinforced concrete work in all sorts of structures including distribution bars, stirrups, binders etc initial straightening and removal of loose rust (if necessary), cutting to requisite length, hooking and bending to correct shape, placing in proper position and binding with 16 gauge black annealed wire at every intersection, complete as per drawing and direction. (a) For works in foundation and upto roof of ground floor/upto 4 m. (i) Tor steel/Mild Steel , JSPL/SWAYN/ELETRO/STEEL PWD Building Works schedule, Page - 43, Item - 40.a.i.1(Corri. 10th Page-01, Date-23-01-2020) (Rate Analysis) Item no , vol of conc. $7.61 \times 1.20 \% = 0.0913 \text{ m}^3 \times 35.315 \text{ c.ft} = 3.224 \text{ c.ft} \times 225 \text{ kg} = 725.40 \text{ kg} = 0.725 \text{ MT}$ | 0.724 | 60315.28 | M.T. | 43668.26 |

| SL.NO | Item Description & Item No. | Quantity | Rate | Unit | Amount |
|-------|--|----------|---------|------|-----------|
| 14 | Collapsible gate with 40 mm x 10 mm x 6 mm Tee as top and bottom guide rail , 20 mm x 10 mm x 2 mm vertical channels 100 mm apart in fullt stretched position 20m x 5 mm MS flats as collapsible bracings properly reveted and washered including 38 mm steel roller including locking arrangements , fitted and fixed in position with lugs set in cement concrete including cutting necessary hikes chasing etc in walls , floors etc and making good all damages . PWD Building Works schedule, Page -106, Item- .18 $2 \times 1.00 \times 2.10 = 4.20 \text{ m}^2$ | 4.20 | 3773.00 | Sqm | 15846.60 |
| 15 | Brick work with 1st class bricks in cement mortar (1:4) (a) Foundation and plinth ground floor PWD Building Works schedule, Page -15, Item-7.a (Rate Analysis) $2 \times 5.10 \times 0.250 \times 0.600 = 1.53 \text{ m}^3$ $3 \times 4.550 \times 0.250 \times 0.600 = 1.2.048 \text{ m}^3$ $2 \times 2.50 \times 0.250 \times 0.600 = 0.750 \text{ M}^3$ $2 \times 1.00 \times 0.500 \times 0.300 = 0.300 \text{ M}^3$ | 3.785 | 5172.40 | Cu.m | 19577.53 |
| 16 | Brick work with 1st class bricks in cement mortar (1:4) (b) superstructure ground floor PWD Building Works schedule, Page -15, Item-7.b (Rate Analysis) $2 \times 5.10 \times 0.250 \times 3.00 = 7.65 \text{ m}^3$ $3 \times 4.55 \times 0.250 \times 3.00 = 10.238 \text{ m}^3$ | 17.89 | 5836.36 | Cu.m | 104412.48 |
| 17 | Labour for Chipping of concrete surface before taking up Plastering work. PWD Building Works schedule, P-192, It-1 | 23.21 | 21.00 | Sqm | 487.41 |
| 18 | Plaster (to wall, floor, ceiling etc.) with sand and cement mortar including rounding off or chamfering corners as directed and raking out joints including throating, nosing and drip course, scaffolding/staging where necessary (Ground floor).[Excluding cost of chipping over concrete surface] (i) With 1:6 cement mortar (c) 15 mm thick plaster PWD Building Works schedule, P-189 It- No. 1 (Rate Analysis) $2(5.1 + 4.55) \times 3.75 = 72.388 \text{ m}^2$ $2(5.10 + 4.55) \times 3.00 = 57.90 \text{ m}^2$ $3 \times 2 \times 1.00 \times 3.00 = 18.00 \text{ m}^2$ $5 \times 2 \times 1.20 \times 3.00 = 36.00 \text{ m}^2$ | 184.29 | 141.48 | Sqm | 26073.35 |
| 19 | Plaster (to wall, floor, ceiling etc.) with sand and cement mortar including rounding off or chamfering corners as directed and raking out joints including throating, nosing and drip course, scaffolding/staging where necessary (Ground floor).[Excluding cost of chipping over concrete surface] (ii) With 1:4 cement mortar (c) 10 mm thick plaster PWD Building Works schedule, P-189 It- No. 1 (ii)(c) (Rate Analysis) $5.1 \times 4.55 = 23.21 \text{ m}^2$ | 23.21 | 126.48 | Sqm | 2935.60 |
| 20 | Neat cement punning about 1.5 mm thick in wall ,dado, window sills, floors etc . Note cement 0.152 m ³ /100 m ² PWD Building Works schedule, P-192 It- No. 15 $2(5.10 + 4.55) \times 0.75 = 14.48 \text{ m}^2$ | 14.48 | 32.72 | Sq.m | 473.79 |

| SL.NO | Item Description & Item No. | Quantity | Rate | Unit | Amount |
|-------|---|----------|---------|------|----------|
| 21 | Supplying, fitting and fixing fibre reinforced polymer (FRP) Composite door frame as per approved section with glass fibre reinforced plastic moulded skins and a special sandwich core, so as to impart monolitaheic composite structure as per approved technology of Department of Science and Technology (DST) to satisfy IS: 4020 door testing performance criteria.. (i) 66mm x 90mm PWD Building Works schedule, P-115, It - 3 (i) 4 (2x2.10 + 0.75) = 19.80 M | 19.80 | 497.00 | Mtr | 9840.60 |
| 22 | Supplying, fitting & fixing fibre reinforced polymer (FRP) Composite door shutters as per approved design with glass fibre reinforced plastic moulded skins and a special sandwich core, so as to impart monolitaheic composite structure as per approved technology of Department of Science and Technology (DST) to satisfy IS:4020 door testing performance criteria. In ground floor. ii) 25 mm thick P-125, It- 14(ii) 4 x 2.10 x 0.75 = 6.30 m2 | 6.30 | 2581.00 | Sqm | 16260.30 |
| 23 | Anodised aluminium barrel / tower / socket bolt (full covered) of approved manufactured from extruded section conforming to I.S. 204/74 fitted and fixed with cadmium plated screws . (vii) 225mm long x 10mm dia. bolt. PWD Building Works schedule, P-144, It No. 26 (vii) | 5.00 | 84.00 | Each | 420.00 |
| 24 | Iron butt hinges of approved quality fitted and fixed with steel screws, with ISI mark. (viii) 100mm X 75mm X 3.50mm. PWD Building Works schedule, P-140, It No. -5 (viii) | 15.00 | 66.00 | Each | 990.00 |
| 25 | Anodised aluminium decorative handle (hexagonal / fluted) of approed quality fitted and fixed complete. (i) 150mm plate x 10mm dia rod x 12mm hexagonal/fluted. PWD Building Works schedule, Page -146 . Item no-31,(i) | 10.00 | 87.00 | Each | 870.00 |
| 26 | Iron hasp bolt of approved quality fitted and fixed complete (oxidised) with 16mm dia rod with concrete bolt and round fitting. .b)250mm long. PWD Building Works schedule, Page -141 . Item no-10 b) | 5.00 | 159.00 | Each | 795.00 |
| 27 | Supplying and laying chequered tiles of any shede and of approved quality with (1:1.5:3) cement concrete laied in pannels or patterns as directed in pavement ,footpath etc including necessary underlay 25 mm thick (avg)cement mortar (1:3) complete in all respect with all labour and materials. (Using cement slurry @4.4kg/sq.m at back side and @2.4 kg/sq.m for joint filling). PWD Building Works schedule, Page -74 , Item no- 46(i). 25 mm thick 2 x 2.00 x1.00 = 4.00 m2 | 4.00 | 467.00 | sq.m | 1868.00 |
| 28 | Rendering the Surface of walls and ceiling with White Cement base WATER PROOF wall putty of approved make & brand.(1.5 mm thick) In Ground Floor PWD Building Works schedule, PWD, P- 198, I - 5 184.26 + 23.21 = 207.50 m2 | 207.50 | 122.00 | Sqm | 25315.00 |

| SL.NO | Item Description & Item No. | Quantity | Rate | Unit | Amount |
|-------|--|----------|---------|------|-----------|
| 29 | Applying interior grade Acrylic Primer of approved quality and brand on plastered and concrete surface old or new surface to receive Distemper Acrylic emulsion paint including scraping and preparing the surface thoroughly , complete as per manufacturer's specification and as per direction of the E-I-C (Ground Floor) (b) Two Coats PWD Building Works schedule, Page -74 , Item no- 46(i). 57.90 + 28.00 + 36.00 +23.21 - 82.43 = 52.68 m2 | 52.68 | 4420.00 | m2 | 232845.60 |
| 30 | Dry Destempering interial walls or ceiling including cleaning, washing, smoothening surface (b) two coats PWD Building Works schedule, Page -196 , Item no- 9(b) | 52.68 | 49.00 | m2 | 2581.32 |
| 31 | Applying exterior grade Acrylic Primer of approved quality and brand on plastered or concrete surface old or new surface to receive Decorative Textured (Martt Finish) or Smooth Finish Acrylic exterior emulsion paint including scraping and preparing the surface thoroughly , complete as per manufacturer's specification and as per direction of the EIC in Ground Floor (b) two coats. PWD Building Works schedule, Page -196 , Item no- 8(b) | 72.39 | 45.10 | m2 | 3264.79 |
| 32 | Protective and Decorative Acrylic Exterior emulsion paint of approved quality, as per manufacturer's specification and as per direction of EIC to be applied overf Acrylic primer as required. The rate includes cost of materials, labour, scaffolding and all incedental charges but excluding the cost of primer in ground floor (two coats)(a) normal acrylic emulsion. PWD Building Works schedule, Page -197 , Item no- 17(| 72.39 | 67.00 | m2 | 4850.13 |
| 33 | (b) Priming one coat on timber or plastered surface with synthetic oil bound primer of approved quality including smoothening surfaces by sand papering etc. PWD Building Works schedule, Page -200 . Item no- 1 (b) | 6.35 | 38.00 | Sqm | 241.30 |
| 34 | (A) Painting with best quality synthetic enamel paint of approved make and brand including smoothening surface by sand papering etc. including using of approved putty etc. on the surface, if necessary : Page - 200 . Item no- 1 (b) (a) On timber or plastered surface : With super gloss (hi-gloss) - (iv) Two coats (with any shade except white) PWD Building Works schedule, Page -200 . Item no- 2(A)(a)(iv) | 6.35 | 81.00 | Sqm | 514.35 |

| SL.NO | Item Description & Item No. | Quantity | Rate | Unit | Ammount |
|-------|--|----------|----------|------|----------|
| 35 | (a) M.S.or W.I. Ornamental grill of approved design joints continuously welded with M.S, W.I. Flats and bars of windows, railing etc. fitted and fixed with necessary screws and lugs in ground floor. (i) Grill weighing above 10 Kg./sq.mtr and up to 16 Kg./sq. mtr. PWD Building Works schedule, P-104 Item-13 A (i) (3rd Corrigendam Page No 91) 2 x 2.00 x 0.750 = 3.00 m2 6 x 0.600 x 0.600 = 2.16 m2 = 5.16 m2 x 10.00 kg = 51.60 kg = 0.516 qtl | 0.516 | 10021.00 | Qntl | 5170.84 |
| 36 | a) Priming one coat on steel or other metal surface with synthetic oil bound primer of approved quality including smoothening surfaces by sand papering etc. PWD Building Works schedule, P/200 Item-1(a) | 5.16 | 29.00 | Sqm | 149.64 |
| 37 | (A) Painting with best quality synthetic enamel paint of approved make and brand including smoothening surface by sand papering etc. including using of approved putty etc. on the surface, if necessary : (b) On steel or other metal surface : (iv) Two coats (with any shade except white) PWD Building Works schedule, P-200 Item-2(b)(iv) | 5.16 | 79.00 | Sqm | 407.64 |
| 38 | Supplying and laying true to line and level vitrified tiles of approved brand (size not less than 600 mm X 600 mm X 10 mm thick) in floor, skirting etc. set in 20 mm sand cement mortar (1:4) and 2 mm thick cement slurry back side of tiles using cement @ 2.91Kg./sqM or using polymerised adhesive (6 mm thick layer applied directly over finished artificial stone floor/Mosaic etc without any backing course) laid after application slurry using 1.75 Kg of cement per sqM below mortar only, joints grouted with admixture of white cement and colouring Pigment to match with colour of tiles / epoxy grout materials of approved make as directed and removal of wax coating of top surface of tiles with warm water and polishing the tiles using soft and dry cloth upto mirror finish complete including the cost of materials, labour and all other incidental charges complete true to the manufacturer's specification and direction of Engineer-in-Charge. (White cement, synthetic adhesive and grout material to be supplied by the contrr]e) I (I) With application slurry @1.75 kg/ Sq.m, 20 mm sand cement mortar (1:4) & 2 mm thick cement slurry at back side of tiles, 0.2 kg/ Sq.m white cement for joint filling with pigment. (A) Deep Colour & White PWD Building Works schedule, Page-66 Item-36 (A) (3rd Floor 5.10 x 4.55 = 23.21 m2 | 23.21 | 1689.00 | Sqm | 39201.69 |

| SL.NO | Item Description & Item No. | Quantity | Rate | Unit | Amount |
|-------|---|----------|---------|-------|----------|
| 39 | <p>Supplying, fitting & fixing 1st quality Ceramic tiles in walls and floors to match with the existing work & 4 nos. of key stones (10mm) fixed with araldite at the back of each tile & finishing the joints with white cement mixed with colouring oxide if required to match the colour of tiles including roughening of concrete surface, if necessary or by synthetic adhesive & grout materials etc.</p> <p>B) Wall</p> <p>Area of each tile above 0.09 Sq.m</p> <p>ii) Other than Coloured decorative including white</p> <p>PWD Building Works schedule, page-64, Item:35.(B.) (b).(ii) (3rd Corrigendam ,Page 36)</p> <p>2(7.375 + 3.250) x 2.10 = 44.63 m²</p> <p>3x2 x 1.00 x 2.10 = 12.60 m²</p> <p>5 x 2 x 1.20 x 2.10 = 25.20 m²</p> | 82.43 | 1041.00 | Sqm | 85809.63 |
| 40 | <p>Supplying profiles of required section made of Aluminium Alloy Extrusions conforming to IS: 732-1983 and IS: 1285- 1975; Annodized (with required film thickness and specified colour / natural) matt finished conforming to IS: 1868-1983 for fabrication of composit door, sliding & casement windows, partitions, formed of basic sections of any ISI embossed / certified make and brand as per direction of Engineer - In- Charge. (Payment will be made on finished length of the work).</p> <p>(A) In 10-12 Micron thickness Annodizing film</p> <p>i) Natural white h) Louvered window. i) Top, bottom and side member.</p> <p>PWD Building Works schedule, PWD, P-233, I- 1(h) i</p> | 8.40 | 183.00 | M | 1537.20 |
| 41 | ii) Louvered Section. | 7.20 | 658.00 | M | 4737.60 |
| 42 | iii) Cleat angle (Non-annodized). | 6.48 | 263.00 | M | 1704.24 |
| 43 | <p>Supplying bubble free float glass of approved make and brand conforming to IS: 2835-1987.</p> <p>iv) 5mm thick coloured / tinted / smoke glass. PWD Building Works schedule, P-243, I -9</p> | 1.08 | 585.00 | Sq.M. | 631.80 |
| 44 | <p>Painting block letters or digits in Black Japan or any approved paint as per direction.</p> <p>e) Size above 7.5 cm. and upto 10 cm.</p> <p>PWD Building Works schedule, P-268, It-17(e)</p> | 450.00 | 12.00 | Each | 5400.00 |
| 45 | <p>Supplying and planting of different plants / trees (supplying well grown plants bushy and healthy, minimum height as specified i.e. exposed height including all leads and lifts, carriage, handling, manuring applying pesticide and fertilizer etc.</p> <p>i) Furcaria Veriegated 10 to 12 leaves in height 20-30 cm in earthen pot of size 25 cm</p> | 10.00 | 162.00 | Each | 1620.00 |
| 46 | <p>x) Ficus blakii (F. Vivicon) well branched (Bushy) of height 120cm - 135 cm in earthen pot of size 30cm.</p> <p>PWD Building Works schedule, Page -261, It- 9 (x)</p> | 3.00 | 187.00 | Each | 561.00 |
| 47 | <p>xxvi) Areca Palm 4 - 5 suckers of height 90 cm to 105 cm in earthen pots of size 25 cm.</p> <p>PWD Building Works schedule, Page -261, It- 9 (xxvi)</p> | 3.00 | 127.00 | Each | 381.00 |

| SL.NO | Item Description & Item No. | Quantity | Rate | Unit | Amount |
|-------|---|----------|---------|------|----------|
| | SANITARY AND PLUMBING WORKS | | | | 0.00 |
| 48 | Supplying, fitting and fixing Anglo-Indian W.C. in white glazed vitreous china ware of approved make complete in position with necessary bolts, nuts etc. a) With 'P' trap (with vent) PWD S&P Schedule, page-79, item no -3 (a) | 4.00 | 3104.00 | Each | 12416.00 |
| 49 | Supplying, fitting and fixing Closet seat of approved make with lid and C.P. hinges, rubber buffer and brass screws complete .(b) Anglo Indian (i) Plastic (hallow type) White PWD S&P Schedule, page-81,item no 10.b.i | 4.00 | 380.00 | Each | 1520.00 |
| 50 | Supplying, fitting and fixing Flat back urinal (half stall urinal) in white vitreous chinaware of approved make in position with brass screws on 75 mm X 75 mm X 75 mm wooden blocks complete (ii) 470 mm X 280 mm X 340 mm PWD S&P Schedule, page.80,item no-6/(ii) | 3.00 | 945.00 | Each | 2835.00 |
| 51 | Supplying fitting and fixing squatting plate with integrated flushing in white vitreous set in cement concrete (6:3:1) with jhama chips complete. (Payment of concrete will be paid seperately) (I) 450 mm x 350 mm | 2.00 | 881.00 | each | 1762.00 |
| 52 | Supplying, fitting and fixing 10 litre P.V.C. low-down cistern conforming to I.S. specification with P.V.C. fittings complete,C.I. brackets including two coats of painting to bracket etc. PWD S&P Schedule, Page No.-36 Item No.-2, | 4.00 | 1015.00 | Nos | 4060.00 |
| 53 | Supplying,fitting and fixing 32 mm dia. Flush Pipe of approved make with necessary fixing materials and clamps complete. i) Polythene Flush Pipe PWD S&P Schedule, Page no 81. Item no. 11(i) | 4.00 | 155.00 | Each | 620.00 |
| 54 | Supplying, fitting and fixing urinal flush pipe fittings of approved brand. (a) C.P. urinal flush pipe fittings range of one PWD S&P Schedule, S.P.81,item-12/a | 2.00 | 414.00 | Each | 828.00 |
| 55 | Supplying, fitting and fixing white vitreous china best quality approved make wash basin with C.I. brackets on 75 mm X 75 mm wooden blocks, C.P. waste fittings of 32 mm dia., mending good all damages and painting the brackets with two coats of approved paint. (ii) 550 mm X 400 mm size PWD S&P Schedule, P-41, It 2 (ii) | 2.00 | 2208.00 | Each | 4416.00 |
| 56 | Supplying fitting and fixing pedestal of approved make for wash basin (White) PWD S&P Schedule, P-41, It 3 | 2.00 | 1497.00 | Each | 2994.00 |
| 57 | Supplying,fitting and fixing approved brand P.V.C. CONNECTOR white flexible, with both ends coupling with heavy brass C.P. nut, 15 mm dia., (iii) 600 mm long PWD S&P Schedule, Page No.-43 Item No.-9-iii | 5.00 | 107.00 | Each | 535.00 |
| 58 | Supplying,fitting and fixing approved brand 32 mm dia.P.V.C. waste pipe, with PVC coupling at one end fitted with necessary clamps. (iv) 1050 mm long each PWD S&P Schedule, Page No.-43 Item No. 10-iv | 2.00 | 91.00 | Each | 182.00 |

| SL.NO | Item Description & Item No. | Quantity | Rate | Unit | Amount |
|-------|--|----------|---------|------|----------|
| 59 | (f) Hand Shower(Health Faucet) with 1mtr Flexible Tube with Wall Hook(Equivalent to Code No.573 & Model -ALLIED of Jaquar or similar). PWD S&P Schedule, Page No.-3 Item No.- 3 f, | 5.00 | 1251.00 | Each | 6255.00 |
| 60 | (a) (i) Chromium plated Bib Cock short body (Equivalent to Code No. 511 & Model - Tropical / Sumthing Special of ESSCO or similar brand). PWD S&P Schedule, Page No.-6 Item No.-7-a-i | 7.00 | 539.00 | Each | 3773.00 |
| 61 | (b) (i) Chromium plated Stop Cock (Equivalent to Code No. 513(A) & 513(B) & Model - Tropical / Sumthing Special of ESSCO or similar PWD S&P Schedule, Page No.-6 Item No.-7-b-i | 5.00 | 493.00 | Each | 2465.00 |
| 62 | Chromium plated angular Stop Cock with wall flange (Equivalent to Code No. 5053 & Model - Florentine of Jaquar or similar brand). PWD S&P Schedule, Page No.-6 Item No.-7-d-i, | 5.00 | 815.00 | Each | 4075.00 |
| 63 | Supplying, fitting and fixing pillar cock of approved make. a) (i) CP Pillar Cock - 15 mm. (Equivalent to Code No. 507 & Model - Tropical / Sumthing Special of ESSCO or similar brand). (P. No. - 45, Item. No. - 19(a)i, Pwd Sanitary Plumbing Schedule 2017) | 2.00 | 555.00 | Each | 1110.00 |
| 64 | Supplying, fitting and fixing PVC pipes of approved make of Schedule 80 (medium duty) conforming to ASTM D - 1785 and threaded to match with GI Pipes as per IS : 1239 (Part - I). with all necessary accessories, specials viz. socket, bend, tee, union, cross, elbo, nipple, long screw, reducing socket, reducing tee, short piece etc. fitted with holder bats clamps, including cutting pipes, making threads, fitting, fixing etc. complete in all respect including cost of all necessary fittings as required, jointing materials and two coats of painting with approved paint in any position above ground. (Payment will be made on the centre line measurements of total pipe line including all specials. No separate payment will be made for accessories, specials. Payment for painting will be made separately) (a) For Exposed Work PVC Pipes, 25 mm Page No.-12 Item No.-19-i(a), PWD,VOL-II , 2017-18 | 25.00 | 177.00 | Mtr | 4425.00 |
| 65 | (a) (a) For Exposed Work PVC Pipes, 15 mm Page No.-12 Item No.-19-i(a), PWD,VOL-II , 2017-18 | 10.00 | 101.00 | Mtr | 1010.00 |
| 66 | (b) For Concealed Work PVC Pipes, 15 mm Page No.-12 Item No.-19-i(b), PWD,VOL-II , 2017-18 | 10.00 | 137.00 | Mtr | 1370.00 |
| 67 | Supplying and fitting fixing of gunmetal wheel valve of approved brand and make tested to 21 Kg per sq. cm. 25 mm dia(E5) PWD S&P Schedule, P-5 It-5.vii) | 2.00 | 778.00 | Each | 1556.00 |
| 68 | Supplying P.V.C. water storage tank of approved quality with closed top with lid (Black) - Multilayer (b) 1000 litre capacity PWD S&P Schedule, page.37,item no-6 (b) | 2.00 | 5128.00 | Each | 10256.00 |
| 69 | Labour for hoisting plastic water storage tank. (i) Upto 1500 litre capacity. (a) Upto 1st story from G.L. PWD S&P Schedule, page.37,item no-10 (i)(a) | 2.00 | 96.00 | Each | 192.00 |
| 70 | Labour for punching hole in plastic water storage tank upto 50 mm dia. PWD S&P Schedule, (P. No. - 38, Item. No. - 13 | 4.00 | 19.00 | Each | 76.00 |

| SL.NO | Item Description & Item No. | Quantity | Rate | Unit | Ammount |
|-------|---|----------|---------|--------|----------|
| 71 | Supply of UPVC pipes (B Type) & fittings conforming to IS-13592-1992.(A) (i) Single Socketed 3 Meter Length, (b) 110 mm PWD S&P Schedule, Page No.-68 Item No. 23,(A)(i)(b) | 30.00 | 292.00 | Mtr | 8760.00 |
| 72 | (B) Fittings (i) Coupler, (b) 110 mm | 8.00 | 85.00 | Each | 680.00 |
| 73 | (ii) Plain Tee, (b) 110 mm | 12.00 | 85.00 | Each | 1020.00 |
| 74 | (iii) Door Tee, (b) 110 mm | 10.00 | 195.00 | Each | 1950.00 |
| 75 | ix) Bend 45°, (b) 110 mm | 10.00 | 89.00 | Each | 890.00 |
| 76 | xi) Door Bend (T.S.), (b) 110 mm | 7.00 | 147.00 | Each | 1029.00 |
| 77 | xvii) Pipe Clip, (b) 110 mm | 30.00 | 21.00 | Each | 630.00 |
| 78 | xviii) W.C. Connector (150 mm long) 125 X 110(W/WC Ring) 75 mm | 4.00 | 142.00 | Each | 568.00 |
| 79 | xxxii) Plain Floor Trap with Top tile & Strainer 75 mm | 7.00 | 144.00 | Each | 1008.00 |
| 80 | L) Rubber Ring, (b) 110 mm | 15.00 | 17.00 | Each | 255.00 |
| 81 | C)Rubber Lubricant 500 ML | 1.00 | 187.00 | 500 ML | 187.00 |
| 82 | D)Solvent Cement 250 ML | 1.00 | 103.00 | 250 ML | 103.00 |
| 83 | Labour for fitting and fixing U.P.V.C. pipes for above ground work including cost of jointing materials etc. fitting and fixing all necessary specials, cutting pipes, cutting holes in total pipeline including specials. (B) Under ground, (ii) 110 mm dia. PWD S&P Schedule, (P. - 74, Item. No. - 24 (B) | 25.00 | 84.00 | Mtr | 2100.00 |
| 84 | Supplying, fitting & fixing UPVC pipes A- Type and fittings conforming to IS:13592-1992 with all necessary clamps nails, Including making holes in walls, floor etc. cutting trenches in any soil through masonry concrete structures etc if necessary and mending good damages including joining with jointing materails (Spun Yarn, Valamoid/Bitumen/M-Seal etc) complete. A) UPVC Pipes: (i) 75 mm. Dia. (P. - 212, Item. No. - 21 (A)(i) , (B),(c),(i) & (B), (d),(i), Pwd volume- i, 2017) | 30.00 | 188.00 | Mtr | 5640.00 |
| | | 6.00 | 84.00 | Mtr | 504.00 |
| 85 | B) UPVC Fittings: c) Bend 87.5 degree (i) 75 mm. Dia. | 2.00 | 78.00 | Mtr | 156.00 |
| 86 | B) UPVC Fittings: d) Shoe (i) 75 mm. Dia. | | | | |
| 87 | Constructing Inspection pit of inside measurement 600mm X 600mm X upto 600mm (depth) with 250 mm thick 1st. class brick work in cement mortar (1:4) on all sides, bottom of the pit consisting of 100 mm thick cement concrete (1:3:6) with stone chips over a layer of jhama brick flat soling,15 mm thick (1:4) cement plaster to inside walls and out-side walls upto G.L. and 20 mm.thick (1:4) plaster to bottom of the pit, providing necessary invert with cement concrete (1:3:6) with stone chips as per direction, neat cement finishing to entire internal surfaces, top of the pit covered with 100 mm thick R.C.C. slab (1:1.5:3) with stone chips and necessary reinforcements upto 1% and shuttering including 6 mm thick cement plaster (1:4) in all external surfaces of the slab and one 560 mm dia. R.C.C. manhole cover of approved make supplied, fitted and fixed in the slab with necessary fittings, necessary earthwork in excavation in all sorts of soil, filling sides of the pit with earth and removing spoils after work complete in all respect with all costs of labour and materials. i) With Pakur variety (Other than SAIL/TATA/RINL). PWD S&P Schedule, S.P.87,Item No-1/(i), 7th Corrigenda Volume ii | 3.00 | 6627.00 | Each | 19881.00 |

| SL.NO | Item Description & Item No. | Quantity | Rate | Unit | Ammount |
|-------|--|----------|----------|------|----------|
| 88 | Construction of septic tank of different capacities as per approved drawing with 1st class brick work in cement mortar (1:4) including two 560 mm dia. R.C.C. manhole cover (heavy type) of approved make supplied, fitted and fixed in the 100mm thick R.C.C (1:1.5:3) top slab with necessary fittings, 20mm thick cement plaster (4 : 1) with neat cement finish to the internal surfaces and 15 mm thick cement plaster (4 : 1) to outside wall upto 200 mm below G.L floor finished with 25 mm thick grey artificial stone over 100 mm thick R.C.C(1:1.5:3) bottom slab including supplying, fitting and fixing all necessary specials, fittings, S.W. tees, C.I. foot rest etc. including excavation earth in all sorts of soil, shoring, bailing out and pumping out water as necessary, ramming, dressing the bed and fefilling the sides of the tanks with earth, removing spoils, filling up the chamber with clear water, removing foreign materials from the chamber and including constructing attached inspection pit as per approved drawing and connecting all necessary pipes, joints etc. with internal plaster work and artificial stone flooring is to be done with admixture of water proofing compound @ 0.5% by weight of cement with all costs of labour and materials. (ii) For 20 users | 1.00 | 45312.00 | Each | 45312.00 |
| 89 | Construction of circular soak well 2.5 metre deep in all types of sandy soils with dry brick work upto 1.6 metre from the bottom having 150 mm intermediate cement brick work (1:4) band all round and cement brick work (1:4) upto 0.90 metre from top with 20mm thick cement plastering (1:4) to inside face upto the depth of cement brick work, 15mm thick cement plaster (1:4) on outer face from top of the well upto G.L. and 6 mm thick cement plaster (1:4) on top of the R.C.C. cover slab including filling bottom 1.00 metre of inside of the well with brick metal (50 mm to 63 mm size) including R.C.C. cover slab of 100 mm thick with cement conc (1:1.5:3) with stone chips with necessary reinforcement and shuttering including one 560 mm dia. R.C.C. manhole cover (heavy type) of approved make supplied, fitted and fixed in the cover slab with necessary fittings, making necessary arrangements for pipe connections, excavation of well including shoring, dewatering and removing the excess earth from the premises as per direction complete in all respect with all costs of labour and materials. With 250 mm thick dry brick work and 250 mm thick cement brick work (1:6) and 1.00m inside dia. (Other than SAIL/TATA/RINL) S.P.89, Item No-4 7th Corrigenda Volume ii | 1.00 | 15539.00 | Each | 15539.00 |
| 90 | Supplying, fitting and fixing towel rail with two brackets. (a) C.P. over brass (ii) 25 mm dia. and 600 mm long Schedule, p No 82 I No- 22 (a)(ii) PWD S&P | 2.00 | 430.00 | Each | 860.00 |
| 91 | Supplying, fitting and fixing bevelled edged mirror 5.5 mm thick silver red as per I.S. 3438 / 1965 together with brass C.P. hinges. (ii) 600 mm X 450 mm PWD S&P Schedule, P-81, It-15(ii) | 2.00 | 484.00 | Each | 968.00 |
| 92 | Supplying, fitting and fixing soap holder. (b) Fibre glass Sanitary and plumbing work schedule P-82, It-18(b) | 4.00 | 58.00 | Each | 232.00 |

| SL.NO | Item Description & Item No. | Quantity | Rate | Unit | Amount |
|-------|--|----------|--------|---------------------------------|--------------|
| 93 | Supplying, fitting and fixing glass shelf with aluminium guard rails. (a) Ordinary type with 5.5 mm sheet glass (i) 450 mm X 125 mm Sanitary and plumbing work schedule P-81, It-16(a)(i) | 2.00 | 341.00 | Each | 682.00 |
| | | | | Total Rs.(A)= | 9,64,542.30 |
| | | | | Add G.S.T. @ 18% on(A)= | 1,73,617.61 |
| | | | | Total Rs.(B)= | 11,38,159.91 |
| | | | | Add for Cess @ 1% on (B)= | 11,381.60 |
| | | | | Total Rs.(C)= | 11,49,541.51 |
| | | | | Add for Contengency @ 3% on(B)= | 34,144.80 |
| | | | | Total Rs.(D)= | 11,83,686.31 |
| | | | | Say Rs.= | 11,83,686.00 |

Apb
05/08/25
Sub-Assistant Engineer
Gangarampur Municipality

Wib
05/08/25
Chairman
Gangarampur Municipality
Gangarampur, D/Dinajpur

Qe/1/26
M. E. Directorate
Govt. of West Bengal

02/01/26
Assistant Engineer
Balurghat Sub-Division
Under Malda Division
Municipal Engineering Directorate
Govt. of West Bengal

02/01/26
Executive Engineer
Malda Division
M.E. Directorate
Deptt. of UD & MA
Govt. of West Bengal

MODEL DRAWING FOR CONSTRUCTION OF C. T./P.T.
TOILET SEATS 4 Nos URINAL 5 Nos
MODEL NO.- G

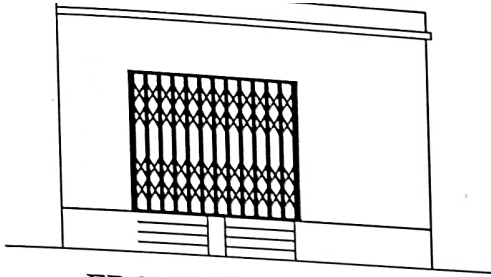

FRONT ELEVATION

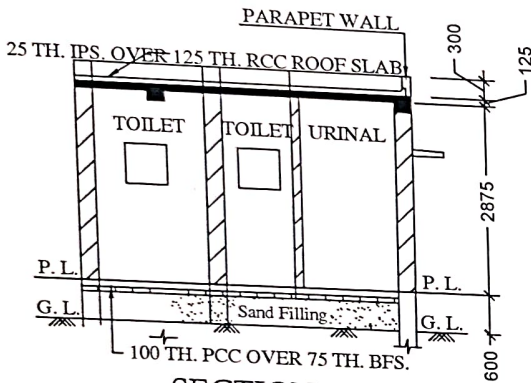

SECTION - 'A - A'

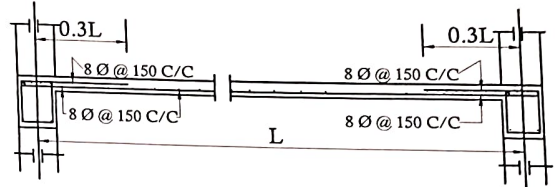
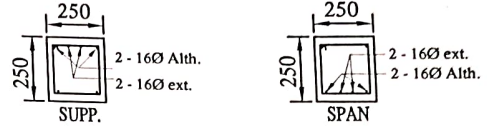

Details Of R.C.C Roof Slab & Beam

(SCALE - 1 : 25)

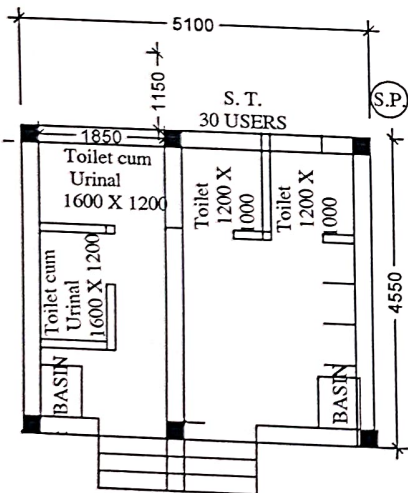

PLAN

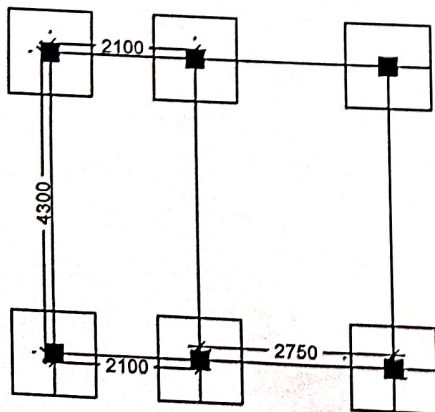
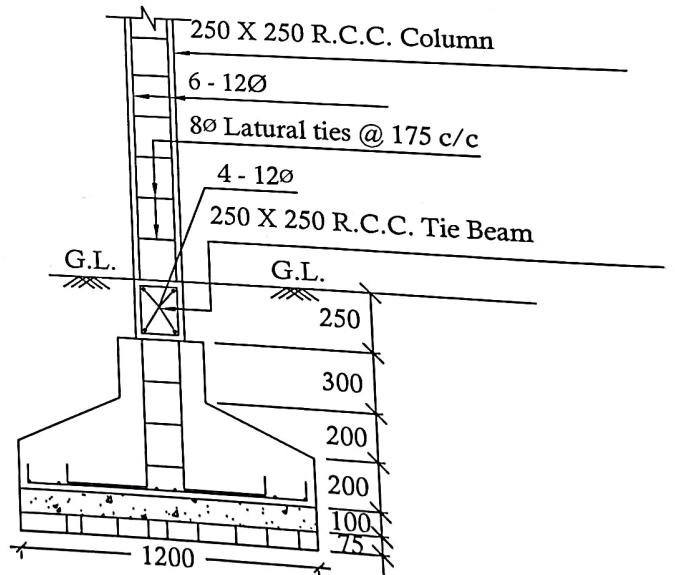

LAYOUT PLAN

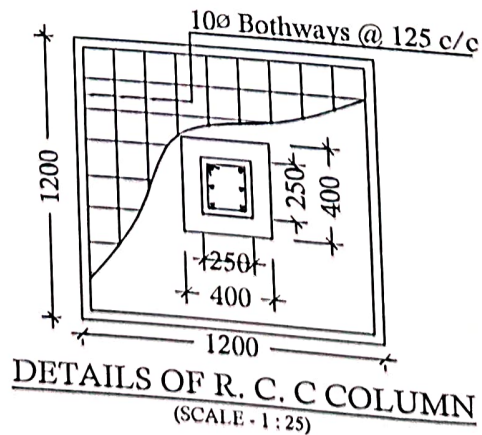

DETAILS OF R. C. C COLUMN

(SCALE - 1 : 25)

Apa
05.08.25
Sub-Assistant Engineer
Gangarampur Municipality

Vinod Kumar
Chairman
Gangarampur Municipality
Gangarampur, Dhanajpur