

ESTIMATE FOR CONSTRUCTION OF COMMUNITY TOILET AT S.R.B.S PRIMARY SCHOOL, WARD NO-01, PLOT NO-1213, MOUZA-LAUTORE, JL-36, UNDER SAINTHIA MUNICIPALITY OF WEST BENGAL (MODEL NO - F)

TOILET SEATS - 2 NOS AND URINAL - 3 NOS

Reference of schedule of Rate : - PWD (W.B.), BUILDING WORKS, [With effect from 01.11.2017]

Incorporation of GST Act, 2017 & All addenda & Corrigenda of SOR, 01.12.2015.

PWD schedule of rates: Building and Sanitary & Plumbing w.e.f 01.11.2017

SL. NO	Item Description & Item No.	Total Quantity	Rate	Unit	Amount
1	Earth work in excavation of foundation trenches or drains, in all sorts of soil (including mixed soil but excluding laterite or sandstone) including removing, spreading or stacking the spoils within a lead of 75 m. as directed. The item includes necessary trimming the sides of trenches, levelling, dressing and ramming the bottom, bailing out water as required complete. (a) Depth of excavation not exceeding 1,500 mm. PWD Building Works schedule Page - 1, Item - 2.a	5.816	119.27	Cum	693.67
2	Earth work in filling in foundation trenches or plinth with good earth, in layers not exceeding 150 mm. including watering and ramming etc. layer by layer complete. (Payment to be made on the basis of measurement of finished quantity of work). (a) With earth obtained from excavation of foundation. PWD Building Works schedule, Page - 1, Item - 3.a 1/5 = 1.163m ³	1.163	77.54	Cum	90.18
3	(A) Filling in foundation or plinth by silver sand in layers not exceeding 150 mm as directed and consolidating the same by thorough saturation with water, ramming complete including the cost of supply of sand. (payment to be made on measurement of finished quantity) 1 x 4.850 PWD Building Works schedule, Page - 2, Item - 4.a x 2.8250 x 0.325 = 4.453 m ³	4.453	572.55	Cum	2549.57
4	Single Brick Flat Soling of picked Jhama bricks including rammimg and dressing bed to proper level and filling joints with local sand. PWD Building Works schedule, Page - 14, Item - 1 (Corri. Page-01, Date-04-06-2018)	21.710	266.00	Sqm	5774.86
5	Ordinary Cement concrete (mix 1:1.5:3) with graded stone chips (20 mm nominal size) excluding shuttering and reinforcement, if any, in ground floor as per relevant IS codes. a) Pakur Variety / Chandil Variety PWD Building Works schedule, p-26 Item 10 a (Rate Analysis)	7.519	4846.48	Cum	36440.68
6	Cement concrete with graded stone ballast (40 mm size excluding shuttering) In ground floor (A) [Pakur Variety] (a) 1:3:6 proportion Page - 34, Item - 22, 1(A,a) Date-04-06-2018 PWD Building Works schedule, Rate Analysis 1 (Corri. Page-3RD, Date-04-06-2018)	2.434	4105.52	Sqm	9992.84
7	25mm. thick damp proof course with cement concrete with stone chips (1:1.5:3) [with graded stone aggregate 10 mm nominal size] and admixture of water proofing compound as per manufacturer's specification followed by two coat of polymer based paint, (1st coat after 4 to 5 days of concrete laying and 2 nd coat just before brick masonry work) as directed (cost of water proofing compound & polymer based paint to be paid separately). (Note: Chqueering not required over concrete or painted surface). [Note: - Waterproofing as per item 9, polymer based paint as per item 8 (a) of subhead C of Section (C). PWD Building Works schedule, Page - 47, Item - 1 (Rate Analysis)	4.544	169.16	Sqm	768.66
			173.00		786.11

(10)

8	15782.31	Sq.M.	27.000	584.53	<p>PWD Building Works schedule, Page -16, Item-16, Item-16, Page -3, date -04.06.2018 (Rate Analysis)</p> <p>125 mm brick work with 1st class bricks in cement mortar (1:4) in ground floor.</p> <p>3x1.00 x3.00 = 9.00 m²</p> <p>5 x1.20 x3.00 = 18.00 m²</p>
9	908.88	Sq.m	37.870	24.00	<p>Item-3</p> <p>Supplying and laying polythine sheet (150 gm/sq.m) over damp proof course or below flooring or roof terracing or foundation trenches.</p> <p>PWD Building Works schedule, Page -47,</p>
10	2163.78	Sqm	10.555	205.00	<p>Item-36.f</p> <p>Works schedule, Page -42,</p> <p>(f) 25 mm to 30 mm shuttering without staging in foundation after completion of works (upto roof of ground floor)</p> <p>upto 4 m using approved stout props and thick hard wood planks of approved thickness with required bracing for concrete slabs, beams and columns, intels curved or straight including fitting, fixing and striking out</p> <p>Hire and labour charges for shuttering with centering and necessary staging</p>
11	9459.05	Sqm	26.058	363.00	<p>Engineer-In-Charge.</p> <p>PWD Building Works schedule, Page -42, Item- 36.a</p> <p>1 x 4.85 x 2.8250 = 13.70 m²</p> <p>2 (4.85 + 2.825) x 0.125 = 1.209 m²</p> <p>4 (.30 + .025) x 3.00 = 6.60 m²</p> <p>2 x 2 x 4.85 x 0.1250 = 2.46 m²</p> <p>2 x 2 x 2.825 x 0.125 = 1.41 m²</p>
12	3258.14 3685.30	Sqm	13.700	240.01 269.00	<p>Artificial stone in floor, dado, staircase etc with cement mortar (1:2:4) with stone chips listed in panels as directed with topping made with ordinary or white cement (as necessary) and marble dust in proportion (1:2) including smooth finishing and rounding off corners including raking out joints or roughening of concrete surface and application of cement slurry before flooring works using cement @ 1.75 kg/sq.m all complete including all materials and labour.</p> <p>In ground floor</p> <p>PWD Building Works schedule, p-48 Item 6(ii)</p>
13	39032.81	M.T.	0.717	54439.07	<p>Reinforcement for reinforced concrete work in all sorts of structures including distribution bars, stirrups, binders etc initial straitening and removal of loose rust (if necessary), cutting to requisite length, hooking and bending to correct shape, placing in proper position and binding with 16 gauge black annealed wire at every intersection, complete as per drawing and direction. (a) For works in foundation and upto roof of ground floor/upto 4 m.</p> <p>(i) Tor steel/Mild Steel, JSPL/SWAYN/ELETR0/STEEL</p> <p>PWD Building Works schedule, Page - 43, Item - 40.a.i.1 (Corr. 10th Page-01, Date-23-01-2020) (Rate Analysis)</p> <p>Item no, vol of conc. 7.519x1.20 % = 0.090 m³ x 35.315 c.ft = 3.186 c.ft x 225 kg = 717.00 kg = 0.717 MT</p>
14	18186.00	Sqm	4.200	4330.00	<p>PWD Building Works schedule, Page -106, Item- 18</p> <p>Collapsible gate with 40 mm x 10 mm x 6 mm Tee as top and bottom guide rail, 20 mm x 10 mm x 2 mm vertical channels 100 mm apart in full stretched position 20m x 5 mm MS flats as collapsible bracings properly reveted and washered including 38 mm steel roller including locking arrangements, fitted and fixed in position with lugs set in cement concrete including cutting necessary hikes chasing etc in walls, floors etc and making good all damages.</p>

15	PWD Building Works schedule, Page -15, Item-7.a (Rate Analysis)	3.776	4198.06	Cu.m	15851.87
16	Brick work with 1st class bricks in cement mortar (1:4) (b) superstructure ground floor PWD Building Works schedule, Page -15, Item-7.b (Rate Analysis)	13.631	4421.06	Cu.m	60263.47
17	Labour for Chipping of concrete surface before taking up Plastering work. PWD Building Works schedule, P-192, It-1	13.700	21.00	Sqm	287.70
18	Plaster (to wall, floor, ceiling etc.) with sand and cement mortar including rounding off or chamfering corners as directed and raking out joints including throating, nosing and drip course, scaffolding/staging where necessary (Ground floor). [Excluding cost of chipping over concrete surface] (i) With 1:6 cement mortar (c) 15 mm thick plaster PWD Building Works schedule, P-189 It- No. 1 (Rate Analysis)	136.560	132.55	Sqm	18101.03
19	Plaster (to wall, floor, ceiling etc.) with sand and cement mortar including rounding off or chamfering corners as directed and raking out joints including throating, nosing and drip course, scaffolding/staging where necessary (Ground floor). [Excluding cost of chipping over concrete surface] (ii) With 1:4 cement mortar (c) 10 mm thick plaster PWD Building Works schedule, P-189 It- No. 1 (ii)(c) (Rate Analysis)	13.700	119.55	Sqm	1637.84
20	Neat cement punning about 1.5 mm thick in wall, dado, window sills, floors etc. Note cement 0.152 m3/100 m2 PWD Building Works schedule, P-192 It- No. 15	11.510	32.76	Sqm	377.07
21	Supplying, fitting and fixing fibre reinforced polymer (FRP) Composite door frame as per approved section with glass fibre reinforced plastic moulded skins and a special sandwich core, so as to impart monolithic composite structure as per approved technology of Department of Science and Technology (DST) to satisfy IS: 4020 door testing performance criteria.. PWD Building Works schedule, P-115, It - 3 (i)	9.900	497.00	MTR	4920.30
22	Supplying, fitting & fixing fibre reinforced polymer (FRP) Composite door shutters as per approved design with glass fibre reinforced plastic moulded skins and a special sandwich core, so as to impart monolithic composite structure as per approved technology of Department of Science and Technology (DST) to satisfy IS:4020 door testing performance criteria. In ground floor. PWD Building Works schedule, P-125, It- 14(ii)	3.150	2581.00	sq.m	8130.15
23	Andosised aluminium barrel / tower / socket bolt (full covered) of approved manufactured from extruded section conforming to I.S. 204/74 fitted and fixed with cadmium plated screws. (vii) 225mm long x 10mm dia. bolt. PWD Building Works schedule, P-144, It No. 26 (vii)	5.000	84.00	Each	420.00
24	Iron butt hinges of approved quality fitted and fixed with steel screws, with ISI mark. (viii) 100mm X 75mm X 3.50mm. PWD Building Works schedule, P-140, It No. - 5 (viii)	15.000	66.00	Each	990.00
25	Andosised aluminium decorative handle (hexagonal / fluted) of approved quality fitted and fixed complete. (i) 150mm plate x 10mm dia rod x 12mm hexagonal/fluted. PWD Building Works schedule, Page -146. Item no-31,(i)	10.000	87.00	Each	870.00
26	Iron hasp bolt of approved quality fitted and fixed complete (oxidised) with 16mm dia rod with concrete bolt and round fitting. PWD Building Works schedule, Page -141. Item no-10 b)	2.000	159.00	Each	318.00

27	Supplying and laying chequered tiles of any shade and of approved quality with (1:1.5:3) cement concrete laid in panels or patterns as directed in pavement, footpath etc including necessary underlay 25 mm thick (avg) cement mortar (1:3) complete in all respect with all labour and materials. (Using cement slurry @ 4.4kg/sq.m at back side and @ 2.4 kg/sq.m for joint filling). PWD Building Works schedule, Page - 74, Item no- 46(i). 25 mm thick	4.130	453.00	sq.m	1883.28 1870.89
28	Rendering the Surface of walls and ceiling with White Cement base WATER PROOF wall putty of approved make & brand.(1.5 mm thick) In Ground Floor PWD Building Works schedule, PWD, P- 198, I - 5 136.56 + 13.70 = 150.26 M2	150.260	122.00	Sqm	18331.72
29	Applying interior grade Acrylic Primer of approved quality and brand on plastered and concrete surface old or new surface to receive Distemper Acrylic emulsion paint including scraping and preparing the surface thoroughly, complete as per manufacturer's specification and as per direction of the E-I-C (Ground Floor) (b) Two Coats PWD Building Works schedule, Page - 74, Item no- 46(i). 44.63 + 19.20 + 13.90 - 13.70 = 66.03 M2	66.030	44.20	m2	2918.53
30	Dry Distempereing interior walls or ceiling including cleaning, washing, smoothening surface (b) two coats PWD Building Works schedule, Page - 196, Item no- 9(b).	66.060	49.00	m2	3236.94
31	Applying exterior grade Acrylic Primer of approved quality and brand on plastered or concrete surface old or new surface to receive Decorative Textured (Martt Finish) or Smooth Finish Acrylic exterior emulsion paint including scraping and preparing the surface thoroughly, complete as per manufacturer's specification and as per direction of the EIC in Ground Floor (b) two coats. PWD Building Works schedule, Page - 196, Item no- 8(b)	57.700	45.10	m2	2602.27
32	Protective and Decorative Acrylic Exterior emulsion paint of approved quality, as per manufacturer's specification and as per direction of EIC to be applied over Acrylic primer as required. The rate includes cost of materials, labour, scaffolding and all incidental charges but excluding the cost of primer in ground floor (two coats)(a) normal acrylic emulsion. PWD Building Works schedule, Page - 197, Item no- 17(a) 79.69+18.00+36.00 = 136.69 m2	57.700	67.00	m2	3865.90
33	(b) Priming one coat on timber or plastered surface with synthetic oil bound primer of approved quality including smoothening surfaces by sand papering etc. PWD Building Works schedule, Page - 200, Item no- 1 (b)	6.350	38.00	Sqm	241.30
34	(A) Painting with best quality synthetic enamel paint of approved make and brand including smoothening surface by sand papering etc. including using of approved putty etc. on the surface, if necessary : Page - 200, Item no- 1 (b) (a) On timber or plastered surface : With super gloss (hi-gloss) - (iv) Two coats (with any shade except white) PWD Building Works schedule, Page - 200, Item no- 2(A)(a)(iv)	6.350	81.00	Sqm	514.35
35	(a) M.S.or W.I. Ornamental grill of approved design joints continuously welded with M.S, W.I. Flats and bars of windows, railing etc. fitted and fixed with necessary screws and lugs in ground floor. (i) Grill weighing above 10 Kg./sq.mtr and up to 16 Kg./sq. mtr. PWD Building Works schedule, P-104 Item-13 A (i) (3rd Corrigendum Page No 91) 1.44 x 0.600 x 0.600 = 1.44 m2 = 1.44 m2 x 10.00 kg = 14.40 kg = 0.144 qtl	0.144	9888.00	Qnt	1423.87

36	PWD Building Works schedule, P/200 Item-1(a) etc. primer of approved quality including smoothing surfaces by sand papering a) Priming one coat on steel or other metal surface with synthetic oil bound	5.640	29.00	Sqm	163.56
37	(A) Painting with best quality synthetic enamel paint of approved make and brand including smoothing surface by sand papering etc. including using of approved putty etc. on the surface, if necessary : (B) On steel or other metal surface : (iv) Two coats (with any shade except white) PWD Building Works schedule, P-200 Item-2(b)(iv)	5.640	79.00	Sqm	445.56
38	Supplying and laying true to line and level vitrified tiles of approved brand (size not less than 600 mm X 600 mm X 10 mm thick) in floor, skirting etc. set in 20 mm sand cement mortar (1:4) and 2 mm thick cement slurry back side of tiles using cement @ 2.91Kg/sqm or using polymerised adhesive (6 mm thick layer applied directly over finished artificial stone floor/Mosaic etc without any backing course) laid after application slurry using 1.75 kg of cement per sqm below mortar only, joints grouted with admixture of white cement and colouring Pigment to match colour of tiles / epoxy grout materials of approved make as directed and removal of wax coating of top surface of tiles with warm water and polishing the tiles using soft and dry cloth upto mirror finish complete including the cost of materials, labour and all other incidental charges complete true to the manufacturer's specification and direction of Engineer-in-Charge. (White cement, synthetic adhesive and grout material to be supplied by the contractor) I (I) With application slurry @ 1.75 kg/ Sq.m, 20 mm sand cement mortar (1:4) & 2 mm thick cement slurry at back side of tiles, 0.2 kg/ Sq.m white cement for joint filling with pigment (A) Deep Colour & White PWD Building Works schedule, Page-66 Item-36 (A) (3rd Floor)	13.700	1679.00	Sqm	23002.3 22961.20
39	Supplying, fitting & fixing 1st quality Ceramic tiles in walls and floors to match with the existing work & 4 nos. of key stones (10mm) fixed with araldite at the back of each tile & finishing the joints with white cement mixed with colouring oxide if required to match the colour of tiles including roughening of concrete surface, if necessary or by synthetic adhesive & grout materials etc. B) Wall Area of each tile above 0.09 Sq.m (ii) Other than Coloured decorative including white PWD Building Works schedule, page-64, Item:35.(B.) (b).(ii) (3rd Corrigendum, Page 36) 2 4.85 + 2.8250) x 2.10 = 36.84 m2 1x2 x 2.325 x 2.10 = 9.77m2 2 x 2 x 1.60 x 2.10 = 13.44 m2	60.050	1029.00	Sqm	51791.45 62872.35
40	Supplying profile of required section made of Aluminium Alloy Extrusions conforming to IS: 732-1983 and IS: 1285- 1975; Anodized (with required film thickness and specified colour / natural) matt finished conforming to IS: 1868-1983 for fabrication of composite door, sliding & casement windows, partitions, formed of basic sections of any ISI embossed / certified make and brand as per direction of Engineer - In-Charge. (Payment will be made on finished length of the work). (A) In 10-12 Micron thickness Anodizing film (I) Natural white h) Louvered window. bottom and side member. PWD Building Works schedule, PWD, P-233, I- 1(h) i	6.500	183.00	MTR	1189.50
41	ii) Louvered Section.	7.200	658.00	MTR	4737.60
42	iii) Cleat angle (Non-anodized).	6.480	263.00	MTR	1704.24
43	Supplying bubble free float glass of approved make and brand conforming to IS: 2835-1987. iv) 5mm thick coloured / tinted / smoke glass. PWD Building Works schedule, P-243, I-9	1.080	585.00	Sq.M.	631.80

44	PWD Building Works schedule, P-268, It-17(e) e) Size above 7.5 cm. and upto 10 cm. direction. Painting block letters or digits in Black Japan or any approved paint as per	450,000	12.00	Each	5400.00
45	Supplying and planting of different plants / trees (supplying well grown plants bushy and healthy, minimum height as specified i.e. exposed height including all leads and lifts, carriage, handling, manuring applying pesticide and fertilizer etc. i) Furcaria Vertegated 10 to 12 leaves in height 20-30 cm in earthen pot of size 25 cm x) Ficus blakii (F. Vivicon) well branched (Bushy) of height 120cm - 135 cm in earthen pot of size 30cm. xxvi) Areca Palm 4 - 5 suckers of height 90 cm to 105 cm in earthen pots of size 25 cm.	10,000	162.00	Each	1620.00
46	PWD Building Works schedule, Page -261, It- 9 (x) in earthen pot of size 30cm.	3,000	187.00	Each	561.00
47	PWD Building Works schedule, Page -261, It- 9 (xxvi) SANITARY AND PLUMBING WORKS	3,000	127.00	Each	381.00
	Supplying, fitting and fixing Anglo-Indian W.C. in white glazed vitreous china ware of approved make complete in position with necessary bolts, nuts etc. a) With 'P' trap (with vent) b) With 'P' trap (with vent)	5,000	3104.00	Each	15520.00
48	Supplying, fitting and fixing Closet seat of approved make with lid and C.P. hinges, rubber buffer and brass screws complete. (b) Anglo Indian (i) Plastic (hallow type) White PWD S&P Schedule, page-81,item no 10.b.i	2,000	380.00	Each	760.00
49	Supplying, fitting and fixing Flat back urinal (half stall urinal) in white vitreous chinaware of approved make in position with brass screws on 75 mm X 75 mm X 75 mm wooden blocks complete (ii) 470 mm X 280 mm X 340 mm PWD S&P Schedule, page,80,item no-6/(ii)	2,000	945.00	Each	1890.00
50	Supplying fitting and fixing squatting plate with integrated flushing in white vitreous set in cement concrete (6:3:1) with jhama chips complete. (1) 450 mm x 350 mm (Payment of concrete will be paid seperately)	2,000	881.00	each	1762.00
51	Supplying, fitting and fixing 10 litre P.V.C. low-down cistern conforming to I.S. specification with P.V.C. fittings complete, C.I. brackets including two coats of painting to bracket etc. PWD S&P Schedule, Page No.-36 Item No.-2,	2,000	1015.00	Nos	2030.00
52	Supplying, fitting and fixing 32 mm dia. Flush Pipe of approved make with necessary fixing materials and clamps complete. i) Polythene Flush Pipe PWD S&P Schedule, Page no 81. Item no. 11(i)	2,000	155.00	Each	310.00
53	Supplying, fitting and fixing urinal flush pipe fittings of approved brand. (a) C.P. urinal flush pipe fittings range of one PWD S&P Schedule, S.P.81,item-12/a	2,000	414.00	Each	828.00
54	Supplying, fitting and fixing white vitreous china best quality approved make wash basin with C.I. brackets on 75 mm X 75 mm wooden blocks, C.P. waste fittings of 32 mm dia., mending good all damages and painting the brackets with two coats of approved paint. (ii) 550 mm X 400 mm size PWD S&P Schedule, P-41, It 2 (iii)	2,000	2208.00	Each	4416.00
55	Supplying, fitting and fixing approved make for wash basin (White) PWD S&P Schedule, P-41, It 3	2,000	1497.00	Each	2994.00
56	Supplying, fitting and fixing approved brand P.V.C. CONNECTOR white flexible, with both ends coupling with heavy brass C.P. nut, 15 mm dia., (iii) 600 mm long PWD S&P Schedule, Page No.-43 Item No.-9-iii	5,000	107.00	Each	535.00

77	Supplying, fitting and fixing approved brand 32 mm dia. P.V.C. waste pipe, (iv) 1050 mm long each	2.000	91.00	Each	182.00
78	PWD S&P Schedule, Page No.-43 Item No. 10-iv (f) Hand Shower (Health Faucet) with 1mtr Flexible Tube with Wall Hook (Equivalent to Code No.573 & Model -ALLIED of Jaquar or similar).	2.000	1251.00	Each	2502.00
59	(a) (i) Chromium plated Bib Cock short body (Equivalent to Code No. 511 & Model - Tropical / Sumthing Special of ESSCO or similar brand). PWD S&P Schedule, Page No.-7-a-1	5.000	539.00	Each	2695.00
60	(b) (i) Chromium plated Stop Cock (Equivalent to Code No. 513(A) & 513(B) & Model - Tropical / Sumthing Special of ESSCO or similar brand). PWD S&P Schedule, Page No.-7-b-1	3.000	493.00	Each	1479.00
61	Chromium plated angular Stop Cock with wall flange (Equivalent to Code No. 5053 & Model - Florentine of Jaquar or similar brand). PWD S&P Schedule, Page No.-7-d-1,	3.000	815.00	Each	2445.00
62	Supplying, fitting and fixing pillar cock of approved make. a) (i) CP Pillar Cock - 15 mm. (Equivalent to Code No. 507 & Model - Tropical / Sumthing Special of ESSCO or similar brand). (P. No. - 45, Item. No. - 19(a)), Pwd Sanitary Plumbing Schedule 2017)	2.000	555.00	Each	1110.00
63	Supplying, fitting and fixing PVC pipes of approved make of Schedule 80 (medium duty) conforming to ASTM D - 1785 and threaded to match with GI Pipes as per IS : 1239 (Part - I), with all necessary accessories, specials viz. socket, bend, tee, union, cross, elbo, nipple, long screw, reducing socket, reducing tee, short piece etc. fitted with holder bats clamps, including cutting pipes, making threads, fitting, fixing etc. complete in all respect including cost of all necessary fittings as required, joining materials and two coats of painting with approved paint in any position above ground. (Payment will be made on the centre line measurements of total pipe line including all specials. No separate payment will be made for accessories, specials. Payment for painting will be made separately) (a) For Exposed Work PVC Pipes, 25 mm PWD S&P Schedule, Page No.-19-i(a), PWD, VOL-II, 2017-18	15.000	177.00	Mtr	2655.00
64	(a) For Exposed Work PVC Pipes, 15 mm PWD S&P Schedule, Page No.-19-i(a), PWD, VOL-II, 2017-18	10.000	101.00	Mtr	1010.00
65	(b) For Concealed Work PVC Pipes, 15 mm PWD S&P Schedule, Page No.-19-i(b), PWD, VOL-II, 2017-18	10.000	137.00	Mtr	1370.00
66	Supplying and fitting fixing of gunmetal valve of approved brand and make tested to 21 Kg per sq. cm. 25 mm dia (E5) PWD S&P Schedule, P-5-It-5,vii),	2.000	778.00	Each	1556.00
67	Supplying P.V.C. water storage tank of approved quality with closed top with lid (Black) - Multilayer (b) 1000 litre capacity PWD S&P Schedule, page:37, item no-6 (b)	2.000	5128.00	Each	10256.00
68	Labour for hoisting plastic water storage tank. (i) Upto 1500 litre capacity. (a) Upto 1st story from G.L. PWD S&P Schedule, page:37, item no-10 (i)(a)	2.000	96.00	Each	192.00
69	Labour for punching hole in plastic water storage tank upto 50 mm dia. PWD S&P Schedule, (P. No. - 38, Item. No. - 13	4.000	19.00	Each	76.00
70	Supply of UPVC pipes (B Type) & fittings conforming to IS-13592- 1992.(A) (i) Single Socketed 3 Meter Length, (b) 110 mm PWD S&P Schedule, Page No.-68 Item No. 23.(A)(i)(b)	30.000	292.00	Mtr	8760.00
71	(B) Fittings (i) Coupler, (b) 110 mm	8.000	85.00	Each	680.00
72	(ii) Plain Tee, (b) 110 mm	12.000	85.00	Each	1020.00
73	(iii) Door Tee, (b) 110 mm	10.000	195.00	Each	1950.00
74	(ix) Bend 45°, (b) 110 mm	10.000	89.00	Each	890.00
75	(xi) Door Bend (T.S.), (b) 110 mm	7.000	147.00	Each	1029.00
76	(xvi) Pipe Clip, (b) 110 mm	30.000	21.00	Each	630.00

78	xvii) W.C. Connector (150 mm long) 125 X 110(W/WC Ring) 75 mm	4.000	142.00	Each	568.00
79	xxxxi) Plain Floor Trap with Top tile & Strainer 75 mm	7.000	144.00	Each	1008.00
80	L) Rubber Ring, (b) 110 mm	15.000	17.00	Each	255.00
81	C) Rubber Lubricant 500 ML	1.000	187.00	500 ML	187.00
82	D) Solvent Cement 250 ML	1.000	103.00	250 ML	103.00
83	PWD S&P Schedule, (P. - 74, Item. No. - 24 (B)) 110 mm dia. pipes, cutting holes in total pipeline including specials. (B) Under ground, (ii) cost of joining materials etc. fitting and fixing all necessary specials, cutting labour for fitting and fixing U.P.V.C. pipes for above ground work including	20.000	84.00	Mtr	1680.00
84	Supplying, fitting & fixing UPVC pipes A- Type and fittings conforming to IS:13592-1992 with all necessary clamps nails, including making holes in walls, floor etc. cutting trenches in any soil through masonry concrete structures etc if necessary and mending good damages including joining with joining materials (Spun Yarn, Valamoid/Bitumen/M-Seal etc) complete. A) UPVC Pipes: (i) 75 mm. Dia. (P. - 212, Item. No. - 21 (A)(i), (B),(c),(i) & (B), (d),(i), Pvd volume- i, 2017)	20.000	188.00	Mtr	3760.00
85	B) UPVC Fittings: c) Bend 87.5 degree (i) 75 mm. Dia.	6.000	84.00	Mtr	504.00
86	B) UPVC Fittings: d) Shoe (i) 75 mm. Dia.	2.000	78.00	Mtr	156.00
87	Constructing inspection pit of inside measurement 600mm X 600mm X upto 600mm (depth) with 250 mm thick 1st. class brick work in cement mortar (1:4) on all sides, bottom of the pit consisting of 100 mm thick cement concrete (1:3:6) with stone chips over a layer of jhama brick flat soling, 15 mm thick (1:4) cement plaster to inside walls and out-side walls upto G.L. and 20 mm thick (1:4) plaster to bottom of the pit. providing necessary invert with cement concrete (1:3:6) with stone chips as per direction, neat cement finishing to entire internal surfaces, top of the pit covered with 100 mm thick R.C.C. slab (1:1.5:3) with stone chips and necessary reinforcements upto 1% and shuttering including 6 mm thick cement plaster (1:4) in all external surfaces of the slab and one 560 mm dia. R.C.C. manhole cover of approved make supplied, fitted and fixed in the slab with necessary fittings, necessary earthwork in excavation in all sorts of soil, filling sides of the pit with earth and removing spoils after work complete in all respect with all costs of labour and materials. i) With Pakur variety (Other than SAIL/TATA/RINL). PWD S&P Schedule, S.P.87, Item No-1/(i), 7th Corrigenada Volume ii	2.000	6153.00	Each	12306.00
88	Construction of septic tank of different capacities as per approved drawing with 1st class brick work in cement mortar (1:4) including two 560 mm dia. R.C.C. manhole cover (heavy type) of approved make supplied, fitted and fixed in the 100mm thick R.C.C (1:1.5:3) top slab with necessary fittings, 20mm thick cement plaster (4 : 1) with neat cement finish to the internal surfaces and 15 mm thick cement plaster (4 : 1) to outside wall upto 200 mm below G.L. floor finished with 25 mm thick grey artificial stone over 100 mm thick R.C.C.(1:1.5:3) bottom slab including supplying, fitting and fixing all necessary specials, fittings, S.W. tees, C.I. foot rest etc. including excavation earth in all sorts of soil, shoring, bailing out and pumping out water as necessary, ramming, dressing the bed and refilling the sides of the tanks with earth, removing spoils, filling up the chamber with clear water, removing foreign materials from the chamber and including constructing attached inspection pit as per approved drawing and connecting all necessary pipes, joints etc. with internal plaster work and artificial stone flooring is to be done with admixture of water proofing compound @ 0.5% by weight of cement with all costs of labour and materials. (ii) For 20 users A) With Pakur variety. (SW/SPL/SHYAM/SRMB/ELECTROSTEEL/SSL) PWD S&P Schedule, S.P.88, Item No-3(ii)(A) 7th Corrigenada Volume ii	1.000	42400.00	Each	42400.00

Assistant Engineer
 Birbhum Division
 Municipal Engineering Directorate
 Govt. of West Bengal

Jr. Engineer
 Birbhum Division
 M.E. Directorate
 Govt. of West Bengal
 25.06.25

May Be Vetted

Govt of W.B.
 M E Dte.
 Birbhum Division
 Executive Engineer

SAINTHIA MUNICIPALITY
 Sub-Assistant Engineer
 Sainthia, Birbhum

SAINTHIA MUNICIPALITY
 Chairman
 Sainthia, Birbhum

Approved by

Prepared by
 3/6
 2025

Rupees Six Lakh Seventy Three Thousand One Hundred Fifty Three Only

Sl. No.	Description	Unit	Quantity	Rate	Amount	Remarks
89	S.P.89, Item No-4 7th Corrigena Volume II (Other than SAIL/TATA/RINL) inside dia. thick dry brick work and 250 mm thick cement brick work (1:6) and 1.00m complete in all respect with all costs of labour and materials. With 250 mm dewatering and removing the excess earth from the premises as per direction arrangements for pipe connections, excavation of well including shoring, fixed in the cover slab with necessary fittings, making necessary R.C.C. manhole cover (heavy type) of approved make supplied, fitted and with necessary reinforcement and shuttering including one 560 mm dia. R.C.C. cover slab of 100 mm thick with cement conc (1:1.5:3) with stone chips metre of inside of the well with brick metal (50 mm to 63 mm size) including plaster (1:4) on top of the R.C.C. cover slab including filling bottom 1.00 (1:4) on outer face from top of the well upto G.L. and 6 mm thick cement inside face upto the depth of cement brick work, 15mm thick cement plaster (1:4) upto 0.90 metre from top with 20mm thick cement plastering (1:4) to intermediate cement brick work (1:4) band all round and cement brick work with dry brick work upto 1.6 metre from the bottom having 150 mm Construction of circular soak well 2.5 metre deep in all types of sandy soils	Each	1.000	13899.00	13899.00	
90	Supplying, fitting and fixing towel rail with two brackets. (a) C.P. over brass (ii) 25 mm dia. and 600 mm long Schedule, p No 82 I No-22 (a)(iii) PWD S&P	Each	2.000	430.00	860.00	
91	Supplying, fitting and fixing bevelled edged mirror 5.5 mm thick silver red as per I.S. 3438 / 1965 together with brass C.P. hinges. (ii) 600 mm X 450 mm PWD S&P Schedule, P-81, It-15(ii)	Each	2.000	484.00	968.00	
92	Supplying, fitting and fixing soap holder: (b) Fibre glass Sanitary and plumbing work schedule P-82, It-18(b)	Each	2.000	58.00	116.00	
93	Supplying, fitting and fixing glass shelf with aluminium guard rails. (a) Ordinary type with 5.5 mm sheet glass (i) 450 mm X 125 mm Sanitary and plumbing work schedule P-81, It-16(a)(i)	Each	2.000	341.00	682.00	
	Add S.G.S.T. @ 9%			54599.53	548371.04	
	Add C.G.S.T. @ 9%			49353.39	49353.39	
	Cost Of Civil Work			49353.39	49353.39	
	Add Labour, Welfare, Cess. @ 1%			4935.34	64707.83	
	Total Amount Including Labour, Welfare, Cess.			64707.83	64707.83	
	Add Contingency @ 3%			19412.33	19412.33	
	Total Amount Including Labour, Welfare, Cess. and contingency			84120.16	666490.17	
	Say Rs.			671272.00	673153.00	

MODEL DRAWING FOR CONSTRUCTION OF C. T./P.T.
TOILET SEATS 2 NOS URINAL 3 NOS
MODEL NO. - F

Details Of R. C. C Roof Slab & Beam
(SCALE - 1 : 25)

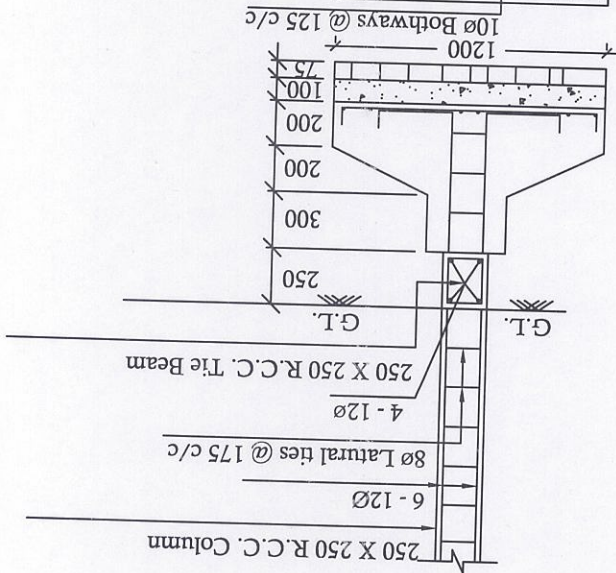
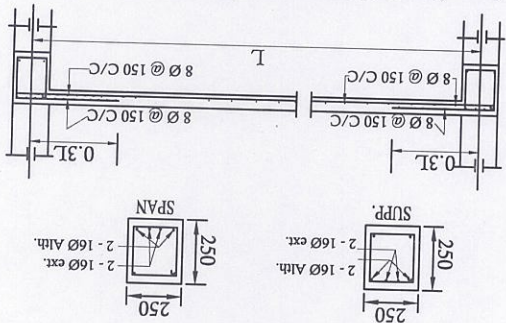

DETAILS OF R. C. C COLUMN
(SCALE - 1 : 25)

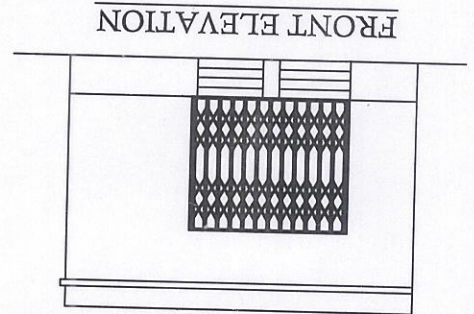
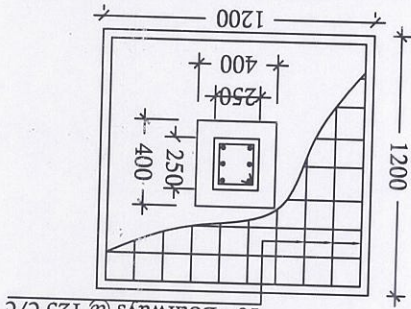

FRONT ELEVATION

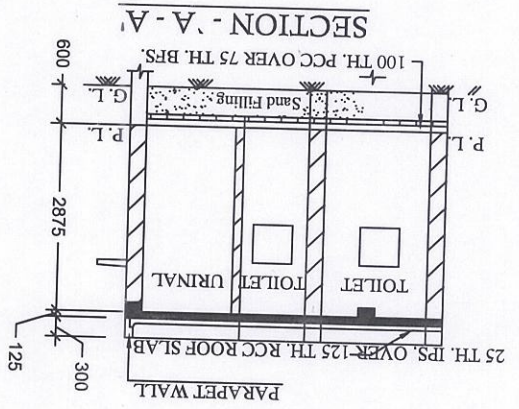

SECTION - A - A'

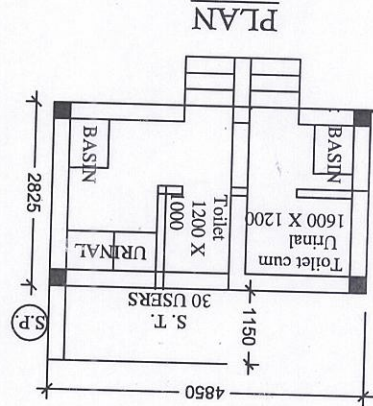

PLAN

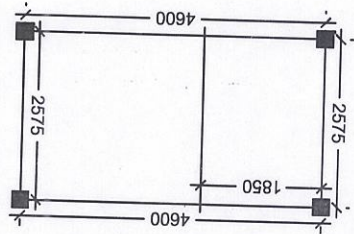

LAYOUT PLAN

Approved by
Chairman
SAINTHIA MUNICIPALITY
Sainthia, Birbhum

Prepared by
Sub- Assistant Engineer
SAINTHIA MUNICIPALITY
Sainthia, Birbhum
3/16
2025