

Estimate for: Construction of Public Toilet Block[Toilet Seat- 2 Nos, Urinal- 3 Nos] at UPHC-I, Muhuripara at Ward No- 18 under Jalpaiguri Municipality[As per Model- F].

Civil Estimate

Sl.No	Description of Item							Quantity	Rte	Unit	Amount
	Location	N	N	L	W/B	H/D	Total				
1	Earth work in excavation of foundation trenches or drains, in all sorts of soil (including mixed soil but excluding laterite or sandstone) including removing, spreading or stacking the spoils within a lead of 75 m. as directed. The item includes necessary trimming the sides of trenches, levelling, dressing and ramming the bottom, bailing out water as required complete. (a) Depth of excavation not exceeding 1,500 mm. [PWD BUILDING WORKS, Page- 1, It. No- 2.a]										
	Column	4.00	1.00	1.20	1.20	1.13	6.48				
	Tie Beam	2.00	1.00	4.35	0.45	0.43	1.66				
		3.00	1.00	2.33	0.45	0.43	1.33				
	Part beam	1.00	1.00	1.60	0.45	0.43	0.31				
		1.00	1.00	1.20	0.45	0.43	0.23				
		1.00	1.00	1.00	0.45	0.43	0.19				
	Stair	1.00	1.00	2.25	0.75	0.08	0.13				
						10.33	10.33	11927.00	%Cum	1232.06	
2	Earth work in filling in foundation trenches or plinth with good earth, in layers not exceeding 150 mm. including watering and ramming etc. layer by layer complete. (Payment to be made on the basis of measurement of finished quantity of work) (a) With earth obtained from excavation of foundation [PWD BUILDING WORKS, Page- 1, It. No- 3.a]										
	2/3 of It. No- 1		0.67	10.33			6.92	6.92	7754.00	%Cum	536.58
3	4 (A) Filling in foundation or plinth by silver sand in layers not exceeding 150 mm as directed and consolidating the same by thorough saturation with water, ramming complete including the cost of supply of sand. (payment to be made on measurement of finished quantity) [PWD BUILDING WORKS, Page- 2, It. No- 4.a]										
	Toilet. urinal	1.00	1.00	1.60	1.20	0.60	1.15				
		1.00	1.00	1.50	1.20	0.60	1.08				
		1.00	1.00	1.00	1.20	0.60	0.72				
		1.00	1.00	1.13	1.00	0.60	0.68				
		1.00	1.00	1.50	2.33	0.60	2.10				
						5.73	5.73	52107.00	%Cum	2985.73	
4	Single Brick Flat Soling of picked jhama bricks including ramming and dressing bed to proper level and filling joints with local sand. [PWD BUILDING WORKS, Page- 14, It. No- 1]										
	Column	4.00	1.00	1.20	1.20		5.76				
	Tie Beam	2.00	1.00	4.35	0.45		3.92				
		2.00	1.00	2.33	0.45		2.09				
	Part Beam	1.00	1.00	1.60	0.45		0.72				
		1.00	1.00	1.20	0.45		0.54				
		1.00	1.00	1.00	0.45		0.45				
	Stair	1.00	1.00	2.25	0.75		1.69				
Floor	1.00	1.00	4.85	2.83		13.7					
						28.87	28.87	324.00	Sq.M.	9353.88	
5	(II) Cement concrete with 30 mm down graded shingles excluding shuttering. N.B. Variety In ground floor (a) 1:3:6 proportion [PWD BUILDING WORKS, Page- 35, It. No- 22,II, a)]										
	Column	4.00	1.00	1.20	1.20	0.10	0.58				
	Tie Beam	2.00	1.00	4.35	0.45	0.10	0.39				
		2.00	1.00	2.33	0.45	0.10	0.21				

		2.00	1.00	2.33	0.45	0.10	0.21				
	Part Beam	1.00	1.00	1.60	0.45	0.10	0.07				
		1.00	1.00	1.20	0.45	0.10	0.05				
		1.00	1.00	1.00	0.45	0.10	0.05				
	Partation wall	2.00	1.00	4.35	0.25	0.60	1.31				
		3.00	1.00	2.33	0.25	0.60	1.05				
		1.00	1.00	1.60	0.25	0.60	0.24				
		1.00	1.00	1.20	0.25	0.60	0.18				
		1.00	1.00	1.00	0.25	0.60	0.15				
	Stair	1.00	1.00	2.25	0.75	0.15	0.25				
		1.00	1.00	2.25	0.50	0.15	0.17				
		1.00	1.00	2.25	0.25	0.15	0.08				
	Floor	1.00	1.00	4.85	2.83	0.10	1.37				
							6.15		3260.93	Cu.M	20054.72
6	Ordinary Cement concrete (mix 1:1.5:3) with graded stone chips (20 mm nominal size) excluding shuttering and reinforcement if any, in ground floor as per relevant IS codes. (i) Pakur Variety [PWD BUILDING WORKS, Page- 26, It. No- 10. i]										
	Footing	4.00	1.00	1.20	1.20	0.20	1.15				
	(1.20 + 0.40) / 2 = 0.80	4.00	1.00	0.80	0.80	0.20	0.51				
		4.00	1.00	0.40	0.40	0.30	0.19				
	Tie Beam	3.00	1.00	2.33	0.25	0.25	0.44				
	Part beam	1.00	1.00	1.20	0.25	0.25	0.08				
	Tie Beam	2.00	1.00	4.35	0.25	0.25	0.54				
	Part beam	1.00	1.00	1.60	0.25	0.25	0.1				
	Part beam	1.00	1.00	1.00	0.25	0.25	0.06				
	Co[3.0+(0.6-0.25)]= 3.35	4.00	1.00	0.25	0.25	3.35	0.84				
	Lintel	3.00	1.00	2.33	0.25	0.20	0.35				
		2.00	1.00	4.35	0.25	0.20	0.44				
	Protection wall	1.00	1.00	1.60	0.13	0.20	0.04				
		1.00	1.00	1.20	0.13	0.20	0.03				
		1.00	1.00	1.00	0.13	0.20	0.03				
	Chazza	3.00	1.00	0.50	0.45	0.10	0.07				
	Roof beam	2.00	1.00	4.85	0.25	0.13	0.3				
		3.00	1.00	2.83	0.25	0.13	0.26				
	Roof slab	1.00	1.00	4.85	2.83	0.13	1.71				
							7.14		₹ 5,871.07	Cu.M	41919.44
7	25mm. thick damp proof course with cement concrete with stone chips (1:1.5:3) [with graded stone aggregate 10 mm nominal size] and admixture of water proofing compound as per manufacturer's specification followed by two coat of polymer based paint, (1st coat after 4 to 5 days of concrete laying and 2 nd coat just before brick masonry work) as directed (cost of water proofing compound & polymer based paint to be paid separately).(Chequering not required over concrete or painted surface). [Note: - Waterproofing as per item 9, polymer based paint as per item 8 (a) of subhead C of Section (C). [PWD BUILDING WORKS, Page- 47, It. No- 1]										
	Tie Beam	2.00	1.00	4.35	0.25		2.18				
		3.00	1.00	2.33	0.25		1.74				
	Part beam	1.00	1.00	1.60	0.13		0.2				
		1.00	1.00	1.20	0.13		0.15				
		1.00	1.00	1.00	0.13		0.13				
							4.40		318.33	Sq.M.	1400.65
							4.40		196.00		862.40

5 mm. thick brick work with 1st class bricks in cement mortar (1.4) in ground floor [PWD BUILDING WORKS, Page- 16, It. No- 16]														
Partation wall [3.0-(2+.125)- 2.675]	1.00	1.00	1.60		2.68	4.28								
	1.00	1.00	1.20		2.68	3.21								
	1.00	1.00	1.00		2.68	2.68								
Parapet wall	1.00	1.00	15.35		0.30	4.61								
							14.78	487.92	Sq.M.	7211.47				
9 Supplying and laying Polythene Sheet (150gm / sq.m.) over damp proof course or below flooring or roof terracing or in foundation or in foundation trenches.or. [PWD BUILDING WORKS, Page- 47, It. No- 3]														
							13.70	24.00	Sq.M.	328.80				
10 Hire and labour charges for shuttering with centering and necessary staging upto 4 m using approved stout props and thick hard wood planks of approved thickness with required bracing for concrete slabs, beams and columns, lintels curved or straight including fitting, fixing and striking out after completion of works (upto roof of ground floor) (When the height of a particular floor is more than 4 m the equivalent floor height shall be taken as 4 m and extra for works beyond the initial 4 m ht. shall be allowed under 12 (e) for every 4 m or part thereof) (f) 25 mm to 30 mm shuttering without staging in foundation [PWD BUILDING WORKS, Page- 37, It. No- 36. f]														
Footing	4.00	4.00	1.20		0.20	3.84								
Column	4.00	4.00	0.40		0.30	1.92								
Column	4.00	4.00	0.25		0.60	2.40								
Tie Beam	2.00	2.00	4.35		0.25	4.35								
	3.00	2.00	2.33		0.25	3.49								
Part beam	1.00	2.00	1.60		0.25	0.80								
	1.00	2.00	1.20		0.25	0.60								
	1.00	2.00	1.00		0.25	0.50								
											17.90	205.00	Sq.M.	3669.50
11 Hire and labour charges for shuttering with centering and necessary staging upto 4 m using approved stout props and thick hard wood planks of approved thickness with required bracing for concrete slabs, beams and columns, lintels curved or straight including fitting, fixing and striking out after completion of works (upto roof of ground floor) (When the height of a particular floor is more than 4 m the equivalent floor height shall be taken as 4 m and extra for works beyond the initial 4 m ht. shall be allowed under 12 (e) for every 4 m or part thereof) (a) 25 mm to 30 mm thick wooden shuttering as per decision & direction of Engineer-In-Charge. [PWD BUILDING WORKS, Page- 36, It. No- 36. a]														
Column	4.00	4.00	0.25		2.75	11.00								
Lintel	2.00	2.00	4.85		0.20	3.88								
	3.00	2.00	2.83		0.20	3.39								
Partitaion wall	1.00	2.00	1.60		0.20	0.64								
	1.00	2.00	1.20		0.20	0.48								
	1.00	2.00	1.00		0.20	0.40								
Openning, Door	2.00	1.00	1.05		0.25	0.53								
	2.00	1.00	0.75		0.13	0.19								
Window	3.00	1.00	0.45		0.25	0.34								
Chazza	3.00	1.00	0.50		0.45	0.68								
	3.00	1.00	1.40		0.10	0.42								
Roof beam	4.00	1.00	2.23		0.13	1.11								
	2.00	1.00	4.35		0.13	1.09								
	2.00	1.00	1.60		0.13	0.40								
	2.00	1.00	2.50		0.13	0.63								

	erside	1.00	1.00	15.35		0.25	3.84						
	roof slab	1.00	1.00	4.85	2.83		13.70						
							42.72	42.72	328.00	Sq.M.		14012.16	
	Artificial stone in floor. dado. staircase etc with cement concrete (1:2:4) with stone chips, laid in panels as directed with topping made with ordinary or white cement (as necessary) and marble dust in proportion (1:2) including smooth finishing and rounding off corners including raking out joints or roughening of concrete surface and application of cement slurry before flooring works using cement @ 1.75 kg/sq.m all complete including all materials and labour. In ground floor. 3 mm. thick topping (High polishing grinding on this item is not permitted with ordinary cement). Using grey cement (ii) 25 mm. thick [PWD BUILDING WORKS. Page- 42. It. No- 6. ii]												
	Roof	1.00	1.00	4.85		2.83	13.73	13.73	262.37	Sq.M		3602.34	
13	Reinforcement for reinforced concrete work in all sorts of structures including distribution bars, stirrups, binders etc initial straightening and removal of loose rust (if necessary), cutting to requisite length, hooking and bending to correct shape, placing in proper position and binding with 16 gauge black annealed wire at every intersection, complete as per drawing and direction (a) For works in foundation and upto roof of ground floor/upto 4 m (i) Tor steel/Mild Steel II. JSW/JSPL/SHYAM/ SRMB/BMASL/ELECROSTEEL/SSL [PWD BUILDING WORKS. Page- 43, It. No- 40. a.i]												
	1.20% of Item No(6)	0.01	7.14	7.85			0.673	0.673	58537.78	MT		39395.93	
14	Collapsible gate with 40mm x 40mm x 6mm Tee as top and bottom guide rail, 20mm x 10mm x 2mm vertical channels 100mm apart in fully stretched position 20mm x 5mm M.S. flats as collapsible bracings properly rivetted and washered including 38mm steel rollers including locking arrangements, fitted and fixed in position with lugs set in cement concrete and including cutting necessary holes, chasing etc. in walls, floors etc. and making good damages complete. (Add extra @ 1% for each addl. floor upto 4th floor and @ 1.25% for each addl. floor above 4th floor) In ground floor. [PWD BUILDING WORKS, Page- 106, It. No- 18]												
		2.00		1.00	2.10		4.20	4.20	4351.00	Sq.M		18274.20	
15	Brick work with 1st class bricks in cement mortar (1:4) (b) In superstructure, ground floor [PWD BUILDING WORKS, Page- 15, It. No- 7. b]												
	[3.0-(.25+.2) = 2.55]	1.00	3.00	2.83	0.25	2.55	5.40						
		1.00	2.00	2.35	0.25	2.55	3.00						
	Deduction												
	Window	-3.00	1.00	0.45	0.25	0.60	-0.2						
	Door	-2.00	1.00	1.05	0.25	2.10	-1.1						
							7.10	7.10	5324.50	Cu.M		37804.38	
									5028.60			35703.06	
16	Labour for Chipping of concrete surface before taking up Plastering work. [PWD BUILDING WORKS, Page- 192, It. No- 1]												
	Column	4.00	4.00	0.25		3.35	13.4						
	Lintel	3.00	2.00	2.33		0.20	2.79						
		2.00	2.00	4.35		0.20	3.48						
	Partition wall	1.00	2.00	1.60		0.20	0.64						
		1.00	2.00	1.20		0.20	0.48						
		1.00	2.00	1.00		0.20	0.4						
	Below opening						0						
	Window	3.00	1.00	0.45		0.25	0.34						
	Door	2.00	1.00	1.05		0.25	0.53						
		2.00	1.00	0.75		0.13	0.19						
	Chazza	3.00	1.00	1.40		0.10	0.42						

	of beam	2.00	1.00	4.85		0.25	2.43						
		3.00	1.00	2.83		0.25	2.12						
	In side	2.00	2.00	4.35		0.13	2.18						
	Inside	2.00	1.00	2.33		0.13	0.58						
	Roof	1.00	1.00	4.85		4.83	23.4						
							53.38	53.38	21.000 ✓	Sq.M			1120.98
17	Plaster (to wall, floor, ceiling etc.) with sand and cement mortar including rounding off or chamfering corners as directed and raking out joints including throating, nosing and drip course, scaffolding staging where necessary (Ground floor).[Excluding cost of chipping over concrete surface] (i) With 1:6 cement mortar (c) 15 mm thick plaster [PWD BUILDING WORKS, Page- 189, It. No- 1.]												
	Outside	1.00	2.00	4.85		3.90	37.83						
		1.00	2.00	2.83		3.90	22.04						
	Chazza	3.00	1.00	0.45	0.50		0.68						
		3.00	1.00	1.40		0.10	0.42						
	Inside	4.00	1.00	2.33		3.90	36.27						
		2.00	1.00	4.85		3.90	37.83						
	Partion wall	1.00	1.00	1.60		2.88	4.60						
		1.00	1.00	1.20		2.88	3.45						
	Parapet wall	1.00	1.00	1.00		2.88	2.88						
		1.00	2.00	4.73	0.13		1.18						
		1.00	2.00	2.70	0.13		0.68						
	Insde	1.00	2.00	4.35		0.30	2.61						
		1.00	2.00	4.33		0.30	2.60						
	Deduction	-2.00	2.00	1.05		2.10	-8.82						
		-2.00	2.00	0.75		2.10	-6.30						
		-3.00	2.00	0.45		0.60	-1.62						
							136.33	136.33	138.65 ✓	Sq.M			18902.15
18	Plaster (to wall, floor, ceiling etc.) with sand and cement mortar including rounding off or chamfering corners as directed and raking out joints including throating, nosing and drip course, scaffolding/staging where necessary (Ground floor).[Excluding cost of chipping over concrete surface] (ii) With 1:4 cement mortar (c) 10 mm thick plaster [PWD BUILDING WORKS, Page- 189, It. No- 1.]												
	Chazza	3.00	1.00	0.45		0.50	0.68						
	Roof	1.00	1.00	4.35		2.33	10.11						
							10.79	10.79	123.65 ✓	Sq.M			1334.18
									126.00 ✓				-1359.54
19	Neat cement punning about 1.5mm thick in wall, dado, window sill, floor etc. NOTE:Cement 0.152 cu.m per100 sq.m. [PWD BUILDING WORKS, Page- 192, It. No- 15.]												
		1.00	1.00	15.35		0.60	9.21	9.21	32.83 ✓	Sq.M			302.36
20	Supplying, fitting and fixing fibre reinforced polymer (FRP) Composite door frame as per approved section with glass fibre reinforced plastic moulded skins and a special sandwich core, so as to impart monolitaheic composite structure as per approved technology of Department of Science and Technology (DST) to satsify IS: 4020 door testing performance criteria.. (i) 66mm x 90mm [PWD BUILDING WORKS, Page- 115, It. No- 3.ii]												
		2.00	1.00	4.95			9.90	9.90	497.00 ✓	Mtr.			4920.30

	<p>supplying, fitting & fixing fibre reinforced polymer (FRP) Composite door shutters as per approved design with glass fibre reinforced plastic moulded skins and a special sandwich core, so as to impart monolithic composite structure as per approved technology of Department of Science and Technology (DST) to satisfy IS:4020 door testing performance criteria.</p> <p>In ground floor. (ii) 25 mm thick [PWD BUILDING WORKS, Page- 125, It. No- 14.ii]</p>										
		1.00	1.00		0.75	2.10	1.58	1.58	2581.00	Sq.M	4077.98
22	<p>Anodised aluminium barrel / tower / socket bolt (full covered) of approved manufactured from extruded section conforming to I.S. 204/74 fitted and fixed with cadmium plated screws: (vii) 225mm long x 10mm dia. bolt. [PWD BUILDING WORKS, Page- 144, It. No- 26 vi]</p>						2.00	84.00	Each	168.00	
23	<p>Iron butt hinges of approved quality fitted and fixed with steel screws, with ISI mark. (viii) 100mm. X 75mm. X 3.50mm [PWD BUILDING WORKS, Page- 140, It. No- 5, viii]</p>						6.00	66.00	Each	396.00	
24	<p>Anodised aluminium decorative handle (hexagonal / fluted) of approved quality fitted and fixed complete. (i) 150mm plate x 10mm dia rod x 12mm hexagonal/fluted. [PWD BUILDING WORKS, Page- 146, It. No- 31. i]</p>						4.00	87.00	Each	348.00	
25	<p>Iron skeleton bolt of approved quality fitted and fixed complete. (b) 450mm long x 10mm dia rod. [PWD BUILDING WORKS, Page- 141, It. No- 10. b]</p>						2.00	104.00	Each	208.00	
26	<p>Supplying and laying chequered tiles of any shade & of approved quality with (1:1½:3) cement concrete laid in panels or patterns as directed in pavement, footpath etc. including necessary underlay 25 mm thick [avg] cement mortar (1:3) complete in all respect with all labour and materials. [Using cement slurry @ 4.4 kg/Sq.m at back side and @2.4 kg/Sq.m for joint filling] Red Variety (i) 25 mm. thick [PWD BUILDING WORKS, Page- 174, It. No- 46. i]</p>										
		4.00	1.00	2.25		0.15	1.35				
		3.00	1.00	2.25		0.25	1.69				
		1.00	1.00	0.25		0.15	0.04				
		1.00	1.00	0.50		0.15	0.08				
		1.00	1.00	0.75		0.15	0.11				
							3.27	3.27	494.00	Sq.M	1615.38
28	<p>Supplying and laying true to line and level vitrified tiles of approved brand (size not less than 600 mm X 600 mm X 10 mm thick) in floor, skirting etc. set in 20 mm sand cement mortar (1:4) and 2 mm thick cement slurry back side of tiles using cement @ 2.91Kg./sqM or using polymerised adhesive (6 mm thick layer applied directly over finished artificial stone floor/Mosaic etc without any backing course) laid after application slurry using 1.75 Kg of cement per sqM below mortar only, joints grouted with admixture of white cement and colouring pigment to match with colour of tiles / epoxy grout materials of approved make as directed and removal of wax coating of top surface of tiles with warm water and polishing the tiles using soft and dry cloth upto mirror finish complete including the cost of materials, labour and all other incidental charges complete true to the manufacturer's specification and direction of Engineer-in-Charge. (White cement, synthetic adhesive and grout material to be supplied by the contrr]e) I (I) With application slurry @1.75 kg/ Sq.m, 20 mm sand cement mortar (1:4) & 2 mm thick cement slurry at back side of tiles, 0.2 kg/ Sq.m white cement for joint filling with pigment. (A) Deep Colour & White [PWD BUILDING WORKS, Page- 66, It. No- 36. A]</p>										
		1.00	1.00	4.35	2.33		10.11	10.11	1688.00	Sq. M	17065.68

<p>plying, fitting & fixing 1st quality Ceramic tiles in walls and floors to match with the existing work & 4 nos. of key stones (10mm) fixed with araldite at the back of each tile & finishing the joints with white cement mixed with colouring oxide if required to match the colour of tiles including roughening of concrete surface, if necessary or by synthetic adhesive & grout materials etc.</p> <p>B) Wall With Sand Cement Mortar (1:3) 15 mm thick & 2 mm thick cement slurry at back side of tiles using cement @ 2.91 Kg/Sq.m & joint filling using white cement slurry @ 0.20kg Sq.m.</p> <p>(a) Area of each tile upto 0.09 Sq.m (ii) Other than Coloured decorative including white [PWD BUILDING WORKS. Page- 64, It. No- 35, B.b.ii]</p>												
Inside	4.00	1.00	2.33		2.10	19.53						
	2.00	1.00	4.35		2.10	18.27						
	1.00	1.00	1.60		2.10	3.36						
	1.00	1.00	1.20		2.10	2.52						
	1.00	1.00	1.00		2.10	2.1						
Deducting												
Window	3.00	1.00	0.45		0.60	0.81						
Door	2.00	1.00	1.05		2.10	4.41						
	2.00	1.00	0.75		2.10	3.15						
1/3 of opening	0.33	7.56				2.52						
						56.67						
					56.67	703	Sq. M	39839.01				
30	<p>Supplying profiles of required section made of Aluminium Alloy Extrusions conforming to IS: 732-1983 and IS: 1285- 1975; Anodized (with required film thickness and specified colour / natural) matt finished conforming to IS: 1868-1983 for fabrication of composit door, sliding & casement windows, partitions, formed of basic sections of any ISI embossed / certified make and brand as per direction of Engineer - In- Charge. (Payment will be made on finished length of the work).</p> <p>A) In 10-12 Micron thickness Anodizing film I) Natural white h) Louvered window [PWD BUILDING WORKS. Page- 233, It. No- 1, A.I.h.</p>											
	i) Top, bottom and side member.	3.00	1.00	2.10		6.30	6.30	183.00	Mtr.	1152.9		
	ii) Louvered Section.	3.00	1.00	0.60		1.80	1.80	658.00	Mtr.	1184.4		
	iii) Cleat angle (Non-anodized).	3.00	4.00	0.45		5.40	5.40	263.00	Mtr.	1420.2		
31	<p>Labour charge for fabrication and installation of composite door, window, partitions made from anodized extruded alloy aluminium sections for the following units:-</p> <p>(A) Glazed aluminium sliding windows made of extruded and anodized alloy aluminium sections, fabrications, including cutting to proper shape and size, drilling and aligning of window shutter frame fitted with in built locking arrangements, sliding rollers and other necessary fittings, fixture, adhesives and joineries along with extruded neoprene or EPDM gasketing in between window frame and masonry work (walls, column, beam.lintels etc.) as well as between glass and shutter frame for fixing glass and Polysulphide sealant and in between shutter and window frame where necessary including cutting to requisite size and fixing glass as per drawing, specification and direction of EIC.</p> <p>The rate includes the hire charge of all tools and plants, including all incidental charges, adhesive, joineries such as screw, cleat angle etc. but excluding the cost of extruded aluminium sections, glass, neoprene / EPDM gasket, locking arrangement and rollers.</p> <p>v) Louvered window [PWD BUILDING WORKS, Page- 240, It. No- 2, A.v]</p>											
		3.00	1.00	0.45		0.60	0.81	0.81	730.00	Sq. M	591.3	

	Applying bubble free float glass of approved make and brand conforming to IS: 35-1987. (v) 5mm thick coloured / tinted / smoke glass. [PWD BUILDING WORKS, Page- 243, It. No- 9.iv]							0.81	585.00	Sq. M	473.85
33	a) M.S.or W.I. Ornamental grill of approved design joints continuously welded with M.S. W.I. Flats and bars of windows, railing etc. fitted and fixed with necessary screws and lugs in ground floor. (i) Grill weighing above 10 Kg./sq.mtr and up to 16 Kg./sq. mtr. [PWD BUILDING WORKS, Page- 104, It. No- 13. a i]							0.475	9827.00 10021.50	Qntl	4759.98 4667.83
	Pump house	6.00	1.00	0.60		0.60	2.16				
	Window	3.00	1.00	0.45		0.60	0.81				
							2.97				
				2.97	16.00	47.52	0.475				
34	Rendering the Surface of walls and ceiling with White Cement base WATER PROOF wall putty of approved make & brand.(1.5 mm thick) [PWD BUILDING WORKS, Page- 198, It. No- 5]							81.24	122.00	Sq. M	9911.28
	same as- It. No- (17+18)- (19+29)		136.33	10.79	9.21	56.67	81.24				
35	Applying Interior grade Acrylic Primer of approved quality and brand on plastered or concrete surface old or new surface to receive Distemper/ Acrylic emulsion paint including scraping and preparing the surface throughly, complete as per manufacturer's specification and as per direction of the EIC. (In Ground Floor) (b) Two Coats i) Water based interior grade Acrylic Primer [PWD BUILDING WORKS, Page- 196, It. No- 7.b.i]							29.95	4420.00	%Sq.M	1323.79
	Insdie	4.00	1.00	2.33		0.78	7.21				
	3.0-(.125+2.1)= 0.78	2.00	1.00	4.35		0.78	6.74				
		2.00	1.00	1.60		0.78	2.48				
		2.00	1.00	1.20		0.78	1.86				
		2.00	1.00	1.00		0.78	1.55				
	Slab	1.00	1.00	4.35		2.33	10.11				
							29.95				
36	Dry Distemparing to interior walls or ceiling including cleaning, washing, smoothening surface (b) Two coat [PWD BUILDING WORKS, Page- 196, It. No- 7.b.i]							29.95	49.00	Sq. M	1467.55
37	Applying Exterior grade Acrylic primer of approved quality and brand on plastered or concrete surface old or new surface to receive decorative textured (matt finish) or smooth finish acrylic exterior emulsion paint including scraping and preparing the surface throughly, complete as per manufacturer's specification and as per direction of the EIC. In Ground Floor: (b) Two Coats [PWD BUILDING WORKS, Page- 196, It. No- 9..b]							56.60	4510.00	%Sq.M	2552.66
	Outer side	1.00	2.00	4.85		3.60	34.92				
		1.00	2.00	2.83		3.60	20.34				
	Chazza	3.00	2.00	0.45		0.50	1.35				
		3.00	1.00	1.40		0.10	0.42				
	Parapet wall	1.00	2.00	4.85		0.13	1.21				
		1.00	2.00	2.83		0.13	0.71				
	In side	1.00	2.00	2.60		0.30	1.56				
		1.00	2.00	2.33		0.30	1.40				
	Deduction	-3.00	1.00	0.45		0.50	-0.68				
		-2.00	1.05	1.05		2.10	-4.63				
							56.60				

	Supplying, fitting and fixing Closet seat of approved make with lid and C.P. fittings, rubber buffer and brass screws complete. (b) Anglo Indian (i) Plastic (hallow type) black [SANITARY AND DRAINAGE WORKS, Page- 81, It. No- 10. b.i]	2.00	371.00	Each	742.00
48	Supplying, fitting and fixing Flat back urinal (half stall urinal) in white vitreous chinaware of approved make in position with brass screws on 75 mm X 75 mm X 75 mm wooden blocks complete. (ii) 470 mm X 280 mm X 340 mm [SANITARY AND DRAINAGE WORKS, Page- 80, It. No- 6. ii]	2.00	945.00	Each	1890.00
47	Supplying, fitting and fixing Squating plate with integral flushing in white vitreous chinaware of approved make in cement concrete (6:3:1) with jhama chips complete. (Payment of concrete will be paid seperately). (i) 450 mm X 350 mm [SANITARY AND DRAINAGE WORKS, Page- 80, It. No- 7. i]	1.00	881.00	Each	881.00
48	Supplying, fitting and fixing 10 litre P.V.C. low-down cistern conforming to I.S. specification with P.V.C. fittings complete. C.I. brackets including two coats of painting to bracket etc. [SANITARY AND DRAINAGE WORKS, Page- 36, It. No- 2]	2.00	1015.00	Each	2030.00
49	Supplying, fitting and fixing 32 mm dia. Flush Pipe of approved make with necessary fixing materials and clamps complete. i) Polythene Flush Pipe [SANITARY AND DRAINAGE WORKS, Page- 81, It. No-11.i]	2.00	155.00	Each	310.00
50	Supplying, fitting and fixing urinal flush pipe fittings of approved brand. (a) C.P. urinal flush pipe fittings range of one [SANITARY AND DRAINAGE WORKS, Page- 81, It. No-12.a]	3.00	414.00	Each	1242.00
51	Supplying, fitting and fixing white vitreous china best quality approved make wash basin with C.I. brackets on 75 mm X 75 mm wooden blocks, C.P. waste fittings of 32 mm dia., one approved quality brass C.P. pillar cock of 15 mm dia., C.P. chain with rubber plug of 30 mm dia., approved quality P.V.C. waste pipe with C.P. nut 32 mm dia., 900 mm long approved quality P.V.C. connection pipe with heavy brass C.P. nut including mending good all damages and painting the brackets with two coats of approved paint. (ii) 550 mm X 400 mm size [SANITARY AND DRAINAGE WORKS, Page- 41, It. No-2.ii]	2.00	2208.00	Each	4416.00
52	Supplying, fitting and fixing pedestal of approved make for wash basin (white) [SANITARY AND DRAINAGE WORKS, Page- 41, It. No-3]	2.00	1497.00	Each	2994.00
53	Supplying, fitting and fixing approved brand P.V.C. CONNECTOR white flexible, with both ends coupling with heavy brass C.P. nut, 15 mm dia. (iii) 600 mm long [SANITARY AND DRAINAGE WORKS, Page- 43, It. No- 9.iii]	5.00	107.00	Each	535.00
54	Supplying, fitting and fixing approved brand 32 mm dia. P.V.C. waste pipe, with PVC coupling at one end fitted with necessary clamps. (iv) 1050 mm long [SANITARY AND DRAINAGE WORKS, Page- 43, It. No- 10.iv]	4.00	91.00	Each	364.00
55	(f) Hand Shower (Health Faucet) with Imtr Flexible Tube with Wall Hook (Equivalent to Code No. 573 & Model - ALLIED of Jaquar or similar). [SANITARY AND DRAINAGE WORKS, Page- 3, It. No- 3.f]	2.00	1251.00	Each	2502.00
56	(a) (i) Chromium plated Bib Cock short body (Equivalent to Code No. 511 & Model - Tropical / Sumthing Special of ESSCO or similar brand). [SANITARY AND DRAINAGE WORKS, Page- 6, It. No- 7. a.i]	3.00	539.00	Each	1617.00
57	(b) (i) Chromium plated Stop Cock (Equivalent to Code No. 513(A) & 513(B) & Model - Tropical / Sumthing Special of ESSCO or similar [SANITARY AND DRAINAGE WORKS, Page- 6, It. No- 7. b.i]	1.00	493.00	Each	493.00
58	(d) (i) Chromium plated angular Stop Cock with wall flange (Equivalent to Code No. 5053 & Model - Florentine of Jaquar or similar brand). [SANITARY AND DRAINAGE WORKS, Page- 6, It. No- 7. d.i]	5.00	815.00	Each	4075.00

	CP Pillar Cock - 15 mm. (Equivalent to Code No. 507 & Model - Tropical / something Special of ESSCO or similar brand). [SANITARY AND DRAINAGE WORKS, Page- 45, It. No- 19. a.i]	2.00	555.00 ✓	Each	1110.00
59	Supplying, fitting and fixing PVC pipes of approved make of Schedule 80 (medium duty) conforming to ASIMD - 1785 and threaded to match with GI Pipes as per IS : 1239 (Part - I). with all necessary accessories, specials viz. socket, bend, tee, union, cross, elbo, nipple, long screw, reducing socket, reducing tee, short piece etc. fitted with holder bats clamps, including cutting pipes, making threads, fitting, fixing etc. complete in all respect including cost of all necessary fittings as required, jointing materials and two coats of painting with approved paint in any position above ground. (Payment will be made on the centre line measurements of total pipe line including all specials. No separate payment will be made for accessories, specials. Payment for painting will be made seperately) (a) For Exposed Work. PVC Pipes. 25 mm [SANITARY AND DRAINAGE WORKS, Page- 12, It. No- 19. i.a]	15.00	177.00 ✓	Mtr.	2655.00
60	(a) For Exposed Work. PVC Pipes. 15 mm [SANITARY AND DRAINAGE WORKS, Page- 12, It. No- 19. i.a]	10.00	101.00 ✓	Mtr.	1010.00
61	Supplying, fitting and fixing gunmetal wheel valve of approved brand and make tested to 21 kg per sq. cm. (for water lines only). (vii) 25 mm dia [SANITARY AND DRAINAGE WORKS, Page- 5, It. No- 5. vii]	2.00	778.00 ✓	Each	1556.00
62	Supplying P.V.C. water storage tank of approved quality with closed top with lid (Black) - Multilayer (b) 1000 litre capacity [SANITARY AND DRAINAGE WORKS, Page- 37, It. No- 6. b]	2.00	5128.00 ✓	Each	10256.00
63	Labour for hoisting plastic water storage tank. (i) Upto 1500 litre capacity. [SANITARY AND DRAINAGE WORKS, Page- 37, It. No- 10. i]	2.00	96.00 ✓	Each	192.00
64	Labour for punching hole in plastic water storage tank upto 50 mm dia. [SANITARY AND DRAINAGE WORKS, Page- 38, It. No- 13]	2.00	19.00 ✓	Each	38.00
65	Labour for punching hole in plastic water storage tank upto 50 mm dia. [SANITARY AND DRAINAGE WORKS, Page- 37, It. No- 10. i]	2.00	19.00	Each	38.00
66	Supply of UPVC pipes (B Type) & fittings conforming to IS-13592- 1992.(A) (i) Single Socketed 3 Meter Length, (b) 110 mm PWD S&P Schedule, Page No.-68 Item No. 23,(A)(i)(b)	30.00	292.00 ✓	Mtr	8760.00
67	(B) Fittings (i) Coupler, (b) 110 mm	8.00	85.00 ✓	Each	680.00
68	(ii) Plain Tee, (b) 110 mm	12.00	85.00 ✓	Each	1020.00
69	(iii) Door Tee, (b) 110 mm	10.00	195.00 ✓	Each	1950.00
70	ix) Bend 45°, (b) 110 mm	10.00	89.00 ✓	Each	890.00
71	xi) Door Bend (T.S.), (b) 110 mm	7.00	147.00 ✓	Each	1029.00
72	xvi) Pipe Clip, (b) 110 mm	30.00	21.00 ✓	Each	630.00
73	xvii) W.C. Connector (150 mm long) 125 X 110(W/WC Ring) 75 mm	4.00	142.00 ✓	Each	568.00
74	xxxi) Plain Floor Trap with Top tile & Strainer 75 mm	7.00	144.00 ✓	Each	1008.00
75	L) Rubber Ring, (b) 110 mm	15.00	17.00 ✓	Each	255.00
76	C)Rubber Lubricant 500 ML	1.00	187.00 ✓	500 ML	187.00
77	D)Solvent Cement 250 ML	1.00	103.00 ✓	250 ML	103.00

	<p>our for fitting and fixing U.P.V.C. pipes for above ground work including cost of jointing materials etc. fitting and fixing all necessary specials. cutting pipes, cutting holes in total pipeline including specials. (B) Under ground. (ii) 110 mm dia.</p> <p>PWD S&P Schedule, (P. - 74, Item. No. - 24 (B)</p>	20.00	84.00 ✓	Mtr	1680.00
79	<p>Supplying, fitting & fixing UPVC pipes A- Type and fittings conforming to IS:13592-1992 with all necessary clamps nails, including making holes in walls, floor etc. cutting trenches in any soil through masonry concrete structures etc if necessary and mending good damages including joining with jointing materials (Spun Yarn, Valamoid/Bitumen/M-Seal etc) complete.</p> <p>A) UPVC Pipes: (i) 75 mm. Dia. (P. - 212, Item. No. - 21 (A)(i) . (B).(c).(i) & (B). (d).(i). Pwv volume- i, 2017)</p>	20.00	188.00 ✓	Mtr	3760.00
80	B) UPVC Fittings: c) Bend 87.5 degree (i) 75 mm. Dia.	6.00	84.00 ✓	Mtr	504.00
81	B) UPVC Fittings: d) Shoe (i) 75 mm. Dia.	2.00	78.00 ✓	Mtr	156.00
82	<p>Constructing Inspection pit of inside measurement 600mm X 600mm X upto 600mm (depth) with 250 mm thick 1st. class brick work in cement mortar (1:4) on all sides, bottom of the pit consisting of 100 mm thick cement concrete (1:3:6) with stone chips over a layer of jhama brick flat soling, 15 mm thick (1:4) cement plaster to inside walls and out-side walls upto G.L. and 20 mm.thick (1:4) plaster to bottom of the pit, providing necessary invert with cement concrete (1:3:6) with stone chips as per direction, neat cement finishing to entire internal surfaces, top of the pit covered with 100 mm thick R.C.C. slab (1:1.5:3) with stone chips and necessary reinforcements upto 1% and shuttering including 6 mm thick cement plaster (1:4) in all external surfaces of the slab and one 560 mm dia. R.C.C. manhole cover of approved make supplied, fitted and fixed in the slab with necessary fittings, necessary earthwork in excavation in all sorts of soil, filling sides of the pit with earth and removing spoils after work complete in all respect with all costs of labour and materials.</p> <p>i) With Pakur variety (Other than SAIL/TATA/RINL). PWD S&P Schedule, S.P.87,Item No-1/(i), 7th Corrigenda Volume ii</p>	2.00	4650.00 7248.00	Each	12900.00 14496.00
83	<p>Construction of septic tank of different capacities as per approved drawing with 1st class brick work in cement mortar (1:4) including two 560 mm dia. R.C.C. manhole cover (heavy type) of approved make supplied, fitted and fixed in the 100mm thick R.C.C (1:1.5:3) top slab with necessary fittings, 20mm thick cement plaster (4 : 1) with neat cement finish to the internal surfaces and 15 mm thick cement plaster (4 : 1) to outside wall upto 200 mm below G.L floor finished with 25 mm thick grey artificial stone over 100 mm thick R.C.C(1:1.5:3) bottom slab including supplying, fitting and fixing all necessary specials, fittings, S.W. tees, C.I. foot rest etc. including excavation earth in all sorts of soil, shoring, bailing out and pumping out water as necessary, ramming, dressing the bed and refilling the sides of the tanks with earth, removing spoils, filling up the chamber with clear water, removing foreign materials from the chamber and including constructing attached inspection pit as per approved drawing and connecting all necessary pipes, joints etc. with internal plaster work and artificial stone flooring is to be done with admixture of water proofing compound @ 0.5% by weight of cement with all costs of labour and materials.</p> <p>(ii) For 20 users A) With Pakur variety. (JSW/JSPL/SHYAM/SRMB/ELECTROSTEEL/SSL) PWD S&P Schedule, S.P.88,Item No-3(ii)(A) 7th Corrigenda Volume ii</p>	1.00	44519.00 48162.00	Each	44519.00 48162.00

	<p>Construction of circular soak well 2.5 metre deep in all types of sandy soils with brick work upto 1.6 metre from the bottom having 150 mm intermediate cement brick work (1:4) band all round and cement brick work (1:4) upto 0.90 metre from top with 20mm thick cement plastering (1:4) to inside face upto the depth of cement brick work. 15mm thick cement plaster (1:4) on outer face from top of the well upto G.L. and 6 mm thick cement plaster (1:4) on top of the R.C.C. cover slab including filling bottom 1.00 metre of inside of the well with brick metal (50 mm to 63 mm size) including R.C.C. cover slab of 100 mm thick with cement conc (1:1.5:3) with stone chips with necessary reinforcement and shuttering including one 560 mm dia. R.C.C. manhole cover (heavy type) of approved make supplied, fitted and fixed in the cover slab with necessary fittings, making necessary arrangements for pipe connections, excavation of well including shoring, dewatering and removing the excess earth from the premises as per direction complete in all respect with all costs of labour and materials. With 250 mm thick dry brick work and 250 mm thick cement brick work (1:6) and 1.00m inside dia. (Other than SAIL/TATA/RINL) S.P.89.Item No-4 7th Corrigenda Volume ii</p>	1.00	15554.00 16621.00	Each	15554.00 16621.00	
85	<p>Supplying, fitting and fixing towel rail with two brackets. (a) C.P. over brass (ii) 25 mm dia. and 600 mm long PWD S&P Schedule. p No 82 1 No- 22 (a)(ii)</p>	2.00	430.00	Each	860.00	
86	<p>Supplying, fitting and fixing bevelled edged mirror 5.5 mm thick silver red as per I.S. 3438 / 1965 together with brass C.P. hinges. (ii) 600 mm X 450 mm PWD S&P Schedule. P-81. It-15(ii)</p>	2.00	484.00	Each	968.00	
87	<p>Supplying, fitting and fixing soap holder. (b) Fibre glass Sanitary and plumbing work schedule P-82, It-18(b)</p>	2.00	58.00	Each	406.00	
88	<p>Supplying, fitting and fixing glass shelf with aluminium guard rails. (a) Ordinary type with 5.5 mm sheet glass (i) 450 mm X 125 mm Sanitary and plumbing work schedule P-81, It-16(a)(i)</p>	2.00	341.00	Each	682.00	
					4, 79,410.43	
					Total Amount excluding GST	478071.78
					Add CGST @ 9%	43026.42
					Add SGST @ 9%	43026.42
					Total amount including GST	564124.12
					Add Labour Welfare Cess. @ 1%	5641.24
					Total Amount Including L.abour Welfare Cess.	569765.36
					Add Contengency @3%	16923.72
					Total Amount Including L.W.C. and contengency	586689.08
					Say Rupees	586689.00
					43,146.94	
					43,146.94	
					565,704.31	
					5,657.04	
					5,71,361.35	
					16,971.13	
					5,88,332.48	
					5,88,332.00	

Sub-Assistant Engineer
Jalpaiguri Municipality

Executive Officer
Jalpaiguri Municipality

Junior Engineer
Jalpaiguri Division M.E.Dte.
Assistant Engineer
Jalpaiguri Division M.E.Dte.

30/04/25
Executive Engineer
Jalpaiguri Division M.E. Dte

CONSTRUCTION OF PUBLIC TOILET AT UPHC-I, Muhuripara

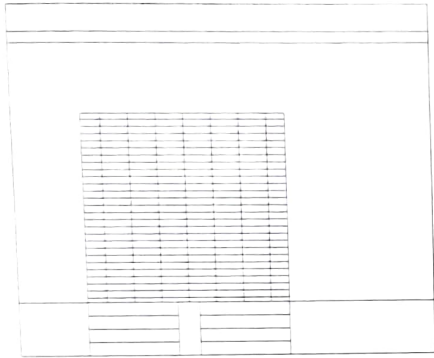

ELEVATION

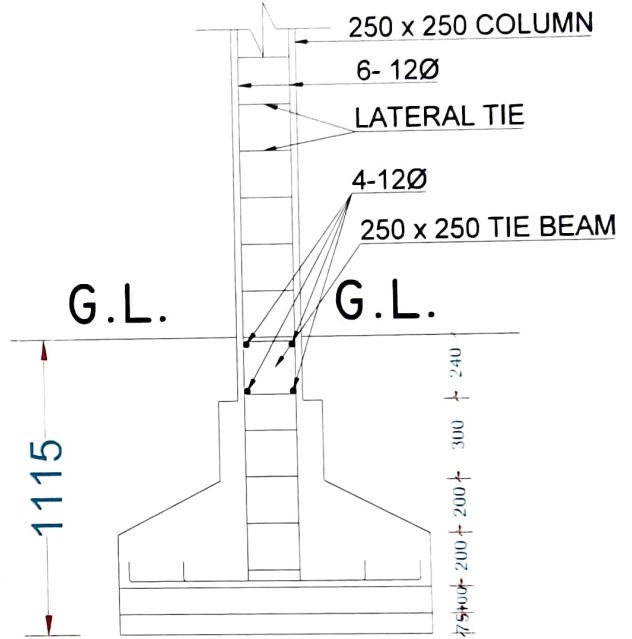

1115

G.L.

G.L.

1200

10Ø MM BAR BOTH WAY

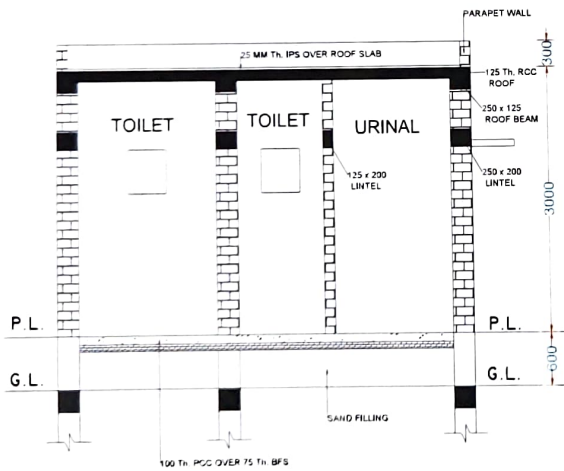

SECTION AT X-X'

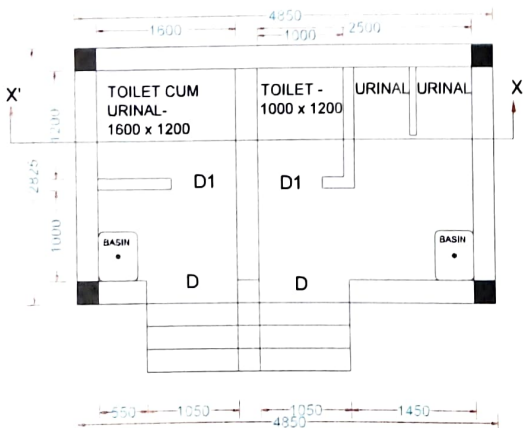

PLAN

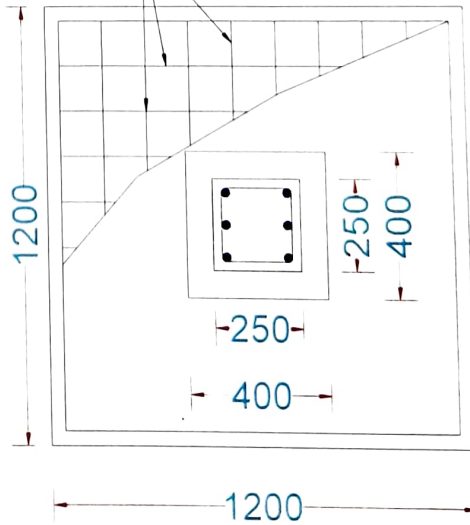

1200

1200

Sub-Assistant Engineer
Jalpaiguri Municipality

Executive Officer
Jalpaiguri Municipality

Non Shedule work estimate

No.	Description of Item	Quantity	Rte	Unit	Amount
1	Non Shedule Item Sl. No. 91-106 (Order as per SUDA) standard plastic dustbin (12lits)	4.00	350.00	Each	1400.00
2	Sinage APC based & Reflective vinyl	5.00	3776.00	each	18880.00 3776
3	Supplying and fixing sinage with fixing stand post for public toilet for visible to	5.00	1000.00	Each	5000.00
4	Glow Sign board Name and contact details of the following are displayed prominently - Toilet Identification number , name of ULB under which jurisdiction toilet is covered , ward number and maintainance authority prominently displayed for each toilet block supervisor, supervisor's agency and area sanitary inspector.	1.00	5000.00	each	5000.00
5	Installation of Sinage	1.00	2071.00	each	2071.00
6	Air freshner(pack of 4nos)	5.00	216.00	Each	1080.00
7	Air freshner (Naphthaline 250 gm)	5.00	210.00	Each	1050.00
8	Supplying paper Napkin	5.00	50.00	Each	250.00
9	Supplying Sanitary Napkin (Whisper or similar make 50 pcs)	4.00	520.00	Each	2080.00
10	Harpic (blue 500 ml)	4.00	300.00	Each	1200.00
11	Harpic (Red 500 ml)	4.00	150.00	Each	600.00
12	Gala double lip floor wiper	4.00	350.00	Each	1400.00
13	Colin glass or surface cleaner	2.00	200.00	Lit	400.00
14	Muriatic Acid	2.00	145.00	Lit	290.00
15	Bleaching powder	4.00	120.00	Kg	480.00
16	Dettol ,lifeboy or similar make liquid soa	6.00	140.00	Lit	840.00
17	Rubber hand gloves	4.00	80.00	Pair	320.00
18	Double side plastic brush	6.00	125.00	Each	750.00
19	Plastic Broom	4.00	170.00	Each	680.00
20	SMS any other ICT based feedback system (With number displayed on which SMS has to be sent)	1.00	5000.00	each	5000.00
21	Mini Tulu Pump	1.00	4000.00	each	4000.00
22	supplying roaster /register for keeping acoount of regular cleanig	3.00	200.00	Each	600.00
23	Lettering on Toilet Wall for display of name and contact details of ULB ward number and name of maintainance authority , saniinspector, etc.	1.00	1000.00	each	1000.00
Total Amount-					54371.00
Add 1% Labor welfare cess-					543.71
Amount including Labor welfare cess-					54914.71
Add 3% Contingency					1631.13
Amount including Contingency					56545.84
Say Rupees					56546.00

Rs 30,262.00
 Rs 302.62
 Rs 30,650.62
 Rs 1,198.41
 Rs 40,837.68
 Rs 40,823.40



 Sub-Assistant Engineer
 Jalpaiguri Municipality

 Saikat Chatterjee
 Vice- Chairman
 Jalpaiguri Municipality

 Executive Officer
 Jalpaiguri Municipality

 Junior Engineer
 Jalpaiguri Division M.E.Dte.

 Assistant Engineer
 Jalpaiguri Division M.E.Dte.

 Executive Engineer
 Jalpaiguri Division M.E. Dte
 30/04/25