

Probable Estimate of civil works for Construction of Public Toilet (PT) at shelter for shelter less Toilet Block (PT) in ward no 25, under Balurghat Municipality.

[Rates taken from PWD Building & Sanitary plumbing Schedule] [Effect from 30th August 2018]

Sl. No.	Page No.	Item of work	No.	L(M)	B(M)	H(M)	Quantity	Total Quantity	Unit	Rate (Rs.)	Amount (Rs.)
1	1/2.a	Earth work in excavation of foundation trenches or drains, in all sorts of soil (including mixed soil but excluding laterite or sandstone) including remixing, spreading or stacking the spoils within a lead of 75 m. as directed. The item includes necessary (Depth not exceeding 1.50 m)									
		Foundation Footing									
		Foundation Tie beam									
		Do					16.02	M ³	119.27	1910.71	
2	1/3.a	Earth work in filling in foundation trenches or plinth with good earth, in layers not exceeding 150 mm. including watering and ramming etc. layer by layer complete.(a) With earth obtained from excavation of foundation.									
		a) For foundation 1/5th of excavation					3.20	M ³	77.54	248.13	
3	P- 2, It no - 4 (A)	Filling in foundation or plinth by silver sand in layers not exceeding 150 mm as directed and consolidating the same by thorough saturation with water, ramming complete including the cost of supply of sand.(payment to be made on measurement of finished quantity)									
		Foundation Footing	4	1.35	1.35	0.075	0.55				
		Floor	1	4.60	4.05	0.425	7.92	8.47	M ³	487.41	4128.36
4	Page -14 , item no. 1.	Single Brick Flat Soling of picked jhama bricks including ramming and dressing bed to proper level and filling joints with local sand.									
		Foundation Footing	6	1.20	1.20		8.64				
		Foundation Tie beam	2	4.60	0.25		2.30				
		Do	3	4.050	0.25		3.04				
		Floor	1	1.825	4.050		7.39				
		do	1	2.53	4.050		10.23	31.60	M ³	324.00	10238.4
5	P - 47, It no 3	Supplying and laying Polythene Sheet (150gm / sq.m.) over damp proof course or below flooring or roof terracing or in foundation or in foundation trenches.									
		Step	1	2.25	0.75		1.69				
			1	2.85	0.75		2.14	3.83	M ²	24.00	91.92
6	P-24 , item no - 4.a	Ordinary Cement concrete (mix 1:2:4) with graded stone chips (20 mm nominal size) excluding shuttering and reinforcement, if any, in ground floor as per relevant IS codes. a) Pakur Variety. Building Schedule .									
		Footing	6	1.200	1.200	0.100	0.86				
		Main floor	1	4.60	4.050	0.100	1.86				
		Step 1	1	2.25	0.750	0.150	0.25				
		Step 2	1	2.25	0.500	0.150	0.17				
		Step 3	1	2.25	0.250	0.150	0.08				
		Front	1	2.85	0.750	0.075	0.16	3.38	M ³	5601.69	18933.71
7	P-15/8.a	Brick work with 1st class bricks in cement mortar (1:6).i In Foundation & plinth a) 250 wall									
		Plinth wall	2	4.350	0.250	0.600	1.31				
		Do	3	4.050	0.250	0.600	1.82	3.13	M ³	5172.4	16189.61
8	Page -47, Item -1 (Rate Analysis)	25mm. thick damp proof course with cement concrete with stone chips (1:1.5:3) [with graded stone aggregate 10 mm nominal size] and admixture of water proofing compound as per manufacturer's specification followed by two coat of polymer based paint, (1st coat after 4 to 5 days of concrete laying and 2 nd coat just before brick masonry work) as directed (cost of water proofing compound & polymer based paint to be paid separately).(Chequering not required over concrete or painted surface). [Note: - Water proofing as per item 9, polymer based paint as per item 8 (a) of subhead C of Section (C), PWD Building Works schedule,									
		Plinth wall	2	4.350	0.250		2.18				
		Do	3	4.050	0.250		3.04	5.22	M ²	206.00	1075.32
9	Page -15, Item-7.b (Rate Analysis)	Brick work with 1st class bricks in cement mortar (1:4), (b) superstructure ground floor, PWD Building Works schedule,									
		Outer wall	2	4.350	0.250	2.725	5.93				
		Do	3	4.050	0.250	2.725	8.28				
		Pillar for water tank	4	0.250	0.250	0.300	0.08				
		Deduct for windows	4	0.600	0.250	0.600	-0.36				
		Deduct for Door	2	1.000	0.250	2.075	-1.04	12.89	M ³	5395.40	69546.71
		125 mm. thick brick work with 1st class bricks in cement mortar (1:4) in ground floor.									
		Inner partition wall	1	1.075		2.875	3.09				

Probable Estimate of civil works for Construction of Public Toilet (PT) at shelter for shelter less Toilet Block (PT) in ward no 25, under Balurghat Municipality.

[Rates taken from PWD Building & Sanitary plumbing Schedule] [Effect from 30th August 2018]

Sl. No.	Page No.	Item of work	No.	L(M)	B(M)	H(M)	Quantity	Total Quantity	Unit	Rate (Rs.)	Amount (Rs.)	
10	P-16/16	Do	1	0.550		2.875	1.58					
		Do	1	1.200		2.875	3.45					
			1	0.450		2.875	1.29					
			2	0.975		2.875	5.61					
		Parapate wall	2	5.400		0.300	3.24					
		do	2	4.600		0.300	2.76	21.02		M ²	674.33	14174.42
11	P-26, item no - 10.a	Ordinary Cement concrete (mix 1:1.5:3) with graded stone chips (20 mm nominal size) excluding shuttering and reinforcement if any, in ground floor as per relevant IS codes.a) Pakur Variety. Building Schedule .										
		Footing	6	1.200	1.200	0.200	1.73					
		Honch	6	0.051			0.31					
		Above Honch	6	0.400	0.400	0.300	0.29					
		Column	6	0.250	0.250	3.325	1.25					
		Tie beam	2	5.100	0.250	0.250	0.64					
		do	3	4.050	0.250	0.250	0.76					
		Tie beam for pertition	2	1.825	0.150	0.150	0.08					
		do	1	2.525	0.150	0.150	0.06					
			1	1.600	0.150	0.150	0.04					
			1	1.200	0.150	0.150	0.03					
		Lintel	2	5.100	0.250	0.150	0.38					
		do	3	4.050	0.250	0.150	0.46					
		do	1	1.825	0.125	0.150	0.03					
		do	1	2.525	0.125	0.150	0.05					
		do	1	1.600	0.125	0.150	0.03					
		do	1	1.075	0.125	0.150	0.02					
		do	1	1.200	0.125	0.150	0.02					
		Roof Beam	2	5.100	0.250	0.150	0.38					
		do	3	4.050	0.250	0.150	0.46					
Slab	1	5.400	4.850	0.100	2.62							
Chajja collapsable gate	1	2.550	0.450	0.075	0.09							
Water Tank Slab	1	1.500	1.500	0.100	0.23	9.96		M ³	6107.32	60828.91		
12	P-44/40.a.i.II	Reinforcement for reinforced concrete work in all sorts of structures including distribution bars, stirrups, binders etc. including supply of rods, initial straightening and removal of loose rust (if necessary), cutting to requisite length, hooking and bending with 16 gauge black annealed wire at every intersection, complete as per drawing and direction.For works in foundation, basement and upto roof of ground floor/upto 4m 1.25 % of concrete work. (JSW/JSPL/SHYAM/SRMB/BMASL/ELECRSTEEL/SSL)										
			1.25%				977.33	0.97733	MT	58250.50	56929.96	
13	42/36.f	Hire and labour charges for shuttering with centering and necessary staging upto 4 m. using approved stout props and thick hard wood planks of approved thickness with required bracing for concrete slabs, beams, column, lintels curved or straight including i) 25 mm. to 30 mm. thick wooden shuttering Without staging as per direction .										
		Column Foundation	6	4.800		0.300	8.64					
		Column above honch	6	1.600		0.300	2.88					
		Tie beam	4	5.100		0.250	5.10					
		do	6	4.050		0.250	6.08					
		Pertition wall tie beam side	4	1.825		0.150	1.10					
		do	2	2.525		0.150	0.76					
			2	1.600		0.150	0.48					
			2	1.075		0.150	0.32					
			2	1.200		0.150	0.36					
Water Tank Slab	4	1.500		0.100	0.60	26.32		M ²	205.00	5395.60		
		Hire and labour charges for shuttering with centering and necessary staging upto 4 m. using approved stout props and thick hard wood planks of approved thickness with required bracing for concrete slabs, beams, column, lintels curved or straight including ii) 25 mm. to 30 mm. thick wooden shuttering With staging as per direction .										
		Column	6	1.000		2.725	16.35					
		Lintel	2	5.100		0.150	1.53					
		do	3	4.050		0.150	1.82					
		do	1	1.825		0.150	0.27					
		do	1	2.525		0.150	0.38					

Probable Estimate of civil works for Construction of Public Toilet (PT) at shelter for shelter less Toilet Block (PT) in ward no 25, under Balurghat Municipality.

[Rates taken from PWD Building & Sanitary plumbing Schedule] [Effect from 30th August 2018]

Sl. No.	Page No.	Item of work	No.	L(M)	B(M)	H(M)	Quantity	Total Quantity	Unit	Rate (Rs.)	Amount (Rs.)
14	42/36.a	do	1	1.600		0.150	0.24				
		do	1	1.075		0.150	0.16				
		do	1	1.200		0.150	0.18				
		Chajja bott	1	2.550		0.450	1.15				
		do side	1	3.450		0.075	0.26				
		Roof Beam	2	5.100		0.150	1.53				
		do	3	4.050		0.150	1.82				
		Slab bott	1	4.600		4.050	18.63				
		Slab curnish bott	2	5.400		0.150	1.62				
		Slab bott	2	4.550		0.150	1.37				
		Slab side	2	5.400		0.100	1.08				
		Do	2	4.850		0.100	0.97	49.36		M ²	328.00
15	189/1.ii.c	Plaster (to wall, floor, ceiling etc. with sand and cement mortar including rounding off or chamfering corners as directed and raking out joints or roughening of concrete surface, including throating, nosing and drip course where necessary (ground floor).									
		i)10 mm. thick plaster.(1:4) Ceiling									
		Ceiling	1	1.825		4.050	7.39				
			1	2.525		4.050	10.23				
		Roof curnish	2	5.400		0.150	1.62				
		do	2	4.550		0.150	1.37				
		Roof side	2	5.400		0.400	4.32				
		do	2	4.850		0.400	3.88				
		Chajja top & bott	2	2.550		0.450	2.30				
		Do side	1	3.450		0.075	0.26				
Col for water tank slab	4	1.000		0.300	1.20	32.57		M ²	126.48	4119.45	
16	P-189, it 1.i.c	Plaster (to wall, floor, ceiling etc. with sand and cement mortar including rounding off or chamfering corners as directed and raking out joints or roughening of concrete surface, including throating, nosing and drip course where necessary (ground floor). iii) 15 mm. thick plaster.(1:6)									
		Outer wall	2	5.100		3.475	35.45				
			2	4.550		3.475	31.62				
			1	1.075		2.875	3.09				
			2	0.975		2.875	5.61				
			1	1.325		2.875	3.81				
		do	2	0.450		2.875	2.59	82.17		M ²	141.48
17	P-192 It- No. 15	Neat cement punning about 1.5 mm thick in wall ,dado, window sills, floors etc. Note cement 0.152 m3/100 m2. PWD Building Works									
		Outer wall	2	5.100		0.600	6.12				
	do	2	4.550		0.600	5.46	11.58		M ²	32.72	378.90
18	Page-106 Item no - 18	Collapsible gate with 40mm x 40mm x 6mm Tee as top and bottom guide rail, 20mm x 10mm x 2mm vertical channels 100mm apart in fully stretched position 20mm x 5mm M.S. flats as collapsible bracings properly rivetted and washered including 38mm steel rollers including locking arrangements, fitted and fixed in position with lugs set in cement concrete and including cutting necessary holes, chasing etc. in walls, floors etc. and making good damages complete.									
			1	2.550		2.150	5.48	5.48		M ²	4351.00
19	P-115, It - 3 (i)	Supplying, fitting and fixing fibre reinforced polymer (FRP) Composite door frame as per approved section with glass fibre reinforced plastic moulded skins and a special sandwich core, so as to impart monolithic composite structure as per approved technology of Department of Science and Technology (DST) to satisfy IS: 4020 door testing performance criteria. (i) 66mm x 90mm.PWD Building Works.									
		D1	4	4.900			19.60	19.60		Mtr	497.00
20	P-125, It- 14(ii)	Supplying, fitting & fixing fibre reinforced polymer (FRP) Composite door shutters as per approved design with glass fibre reinforced plastic moulded skins and a special sandwich core, so as to impart monolithic composite structure as per approved technology of Department of Science and Technology (DST) to satisfy IS:4020 door testing performance criteria. In ground floor. ii) 25 mm thick									
			4	0.750		2.075	6.23	6.23		M ²	2581.00

Probable Estimate of civil works for Construction of Public Toilet (PT) at shelter for shelter less Toilet Block (PT) in ward no 25, under Balurghat Municipality.

[Rates taken from PWD Building & Sanitary plumbing Schedule] [Effect from 30th August 2018]

Sl. No.	Page No.	Item of work	No.	L(M)	B(M)	H(M)	Quantity	Total Quantity	Unit	Rate (Rs.)	Amount (Rs.)
21	P-144, It No. 26 (vii)	Anodised aluminium barrel / tower / socket bolt (full covered) of approved manufactured from extruded section conforming to I.S. 204/74 fitted and fixed with cadmium plated screws . (vii) 225mm long x 10mm dia. bolt. PWD Building Works schedule, P-144, It No. 26 (vii)	1	6.00			6.00	6.00	Nos	84.00	504.00
22	P-140, It No. -5 (viii)	Iron butt hinges of approved quality fitted and fixed with steel screws, with ISI mark. (viii) 100mm X 75mm X 3.50mm. PWD Building Works schedule,	3	6.000			18.00	18.00	Nos	66.00	1188.00
23	Page -146 . Item no- 31,(i)	Anodised aluminium decorative handle (hexagonal / fluted) of approved quality fitted and fixed complete.(i) 150mm plate x 10mm dia rod x 12mm hexagonal/fluted. PWD Building Works schedule,	2	6.000			12.00	12.00	Nos	87.00	1044.00
24	Page -141 . Item no-10 b)	Iron hasp bolt of approved quality fitted and fixed complete (oxidised) with 16mm dia rod with concrete bolt and round fitting. b)250mm long.PWD Building Works schedule,	1	6.000			6.00	6.00	Nos	159.00	954.00
25	Pg-117 of 315, It-B-1(ii)(b)	Panel shutters of door and window, as per design (each panel consisting of single plank without joint), including fitting and fixing the same in position but excluding the cost of hinge and other fittings. (ii) 40 mm thick shutters with 19 mm thick panel of size 30 to 45 cm In ground floor.(In case of non-supply of single plank, penal rate of reduction of 20% will be made)-(b) Sishu, Gamar, Champ,Badam,Bhola, Mogra, Hallak. (ii) 40mm thick shutters with 19mm thick panel of size 30 to 45 cm for Door "D"	2	1.000		2.075	4.15	4.15	M ²	2968.00	12317.2
26	Pg-114 of 315, It-1	Wood work in door and window frame fitted and fixed in position complet including a protective coat of painting at the contact surface of the frame exluding cost of concrete, Iron Butt Hinges and M.S clamps. (The quantum should be corrected upto three decimals).Note: Extra for Lifting Charges for each additional floor, i) Rs. 200/- per Cu.m (upto 4th floor) (d) Sal; Local	2	5.150	0.100	0.075	0.080	0.080	M ³	71907.00	5752.56
27	Pg-140 of 315, It-4©	Supplying, fitting and fixing M.S. clamps for door and window frame made of flat bent bar, end bifurcated with necessary screws etc. by cement concrete(1:2:4) as per direction. (Cost of concrete will be paid separately)- (c) 40mm X 6mm, 125mm Length	2	6.000			12.00	12.00	Each	20.00	240.00
28	Page -74 . Item no- 46(i)	Supplying and laying chequered tiles of any shade and of approved quality with (1:1.5:3) cement concrete laied in pannels or patterns as directed in pavement ,footpath etc including necessary underlay 25 mm thick (avg)cement mortar (1:3) complete in all respect with all labour and materials. (Using cement slurry @4.4kg/sq.m at back side and @2.4 kg/sq.m for joint filling). PWD Building Works schedule, 25 mm thick	1	1.775		0.750	1.33				
		do	1	1.075		0.750	0.81	2.14	M ²	473.00	1012.22
29	PWD, P-198, I- 5	Rendering the Surface of walls and ceiling with White Cement base WATER PROOF wall putty of approved make & brand.(1.5 mm thick) In Ground Floor, PWD Building Works schedule,	1	1.825		4.050	7.39				
		Ceiling	1	2.525		4.050	10.23				
		Inner wall	4	4.050		0.775	12.56				
		do	2	1.825		0.775	2.83				
		do	2	2.525		0.775	3.91				
		do	1	1.075		0.775	0.83				
		do	1	0.975		0.775	0.76				
		do	1	0.850		0.775	0.66				
		do	1	1.200		0.775	0.93				
		do	2	0.450		0.775	0.70				
		do	4	0.125		0.775	0.39				
		Outer wall front	1	5.100		4.050	20.66				
		Chajja top & bott	2	2.550		0.450	2.30				
		Do side	1	3.450		0.075	0.26	64.41	M ²	122.00	7858.02

Probable Estimate of civil works for Construction of Public Toilet (PT) at shelter for shelter less Toilet Block (PT) in ward no 25, under Balurghat Municipality.

[Rates taken from PWD Building & Sanitary plumbing Schedule] [Effect from 30th August 2018]

Sl. No.	Page No.	Item of work	No.	L(M)	B(M)	H(M)	Quantity	Total Quantity	Unit	Rate (Rs.)	Amount (Rs.)
30	Page -74 , Item no-46(i).	Applying interior grade Acrylic Primer of approved quality and brand on plastered and concrete surface old or new surface to receive Distemper Acrylic emulsion paint including scraping and preparing the surface thoroughly , complete as per manufacturer's cation and as per direction of the E-I-C(Ground Floor),(b) Two Coats, PWD Building Works schedule,									
		Ceiling	1	1.825		4.050	7.39				
			1	2.525		4.050	10.23				
		Inner wall	4	4.050		0.775	12.56				
		do	2	1.825		0.775	2.83				
		do	2	2.525		0.775	3.91				
		do	1	1.075		0.775	0.83				
		do	1	0.975		0.775	0.76				
		do	1	0.850		0.775	0.66				
		do	1	1.200		0.775	0.93				
		do	2	0.450		0.775	0.70				
		do	4	0.125		0.775	0.39	41.19	M ²	44.20	1820.6
31	Page -196 , Item no-9(b) .	Dry Destempering interial walls or ceiling including cleaning, washing, smoothening surface (b) two coats, PWD Building Works schedule,									
		Ceiling	1	1.825		4.050	7.39				
			1	2.525		4.050	10.23				
		Inner wall	4	4.050		0.775	12.56				
		do	2	1.825		0.775	2.83				
		do	2	2.525		0.775	3.91				
		do	1	1.075		0.775	0.83				
		do	1	0.975		0.775	0.76				
		do	1	0.850		0.775	0.66				
		do	1	1.200		0.775	0.93				
		do	2	0.450		0.775	0.70				
		do	4	0.125		0.775	0.39	41.19	M ²	49.00	2018.31
32	Page -196 , Item no-8(b)	Applying exterior grade Acrylic Primer of approved quality and brand on plastered or concrete surface old or new surface to receive Decorative Textured (Martt Finish) or Smooth Finish Acrylic exterior emulsion paint including scraping and preparing the surface thoroughly , complete as per manufacturer's specification and as per direction of the EIC in Ground Floor (b) two coats. PWD Building Works schedule,									
		Back & front wall	2	5.100		4.050	41.31				
		Side wall	2	4.550		4.050	36.86				
		Chajja top & bott	2	2.550		0.450	2.30				
		Do side	1	3.450		0.075	0.26	80.73	M ²	45.10	3640.92
33	Page -197 , Item no-17(a)	Protective and Decorative Acrylic Exterior emulsion paint of approved quality, as per manufacturer's specification and as per direction of EIC to be applied overf Acrylic primer as required. The rate includes cost of materials, labour, scaffolding and all incidental charges but excluding the cost of primer in ground floor (two coats)(a) normal acrylic emulsion.PWD Building Works schedule,									
		Back & front wall	2	5.100		4.050	41.31				
		Side wall	2	4.550		4.050	36.86				
		Chajja top & bott	2	2.550		0.450	2.30				
		Do side	1	3.450		0.075	0.26	80.73	M ²	67.00	5408.91
34	Page -200 . Item no-1 (b)	(b) Priming one coat on timber or plastered surface with synthetic oil bound primer of approved quality including smoothening surfaces by sand papering etc. PWD Building Works schedule,									
		Frame D	2	5.150		0.350	3.61				
		Shutter D	4	1.000		2.075	8.30	11.91	M ²	38.00	452.58
35	Page - 200 . Item no- 1 (b) 2(A)(a)(iv)	(A) Painting with best quality synthetic enamel paint of approved make and brand including smoothening surface by sand papering etc. including using of approved putty etc. on the surface, if necessary : (a) On timber or plastered surface : With super gloss (hi-gloss) - (iv) Two coats (with any shade except white) PWD Building Works schedule,									
		Frame D	2	5.150		0.350	3.61				
		Shutter D	4	1.000		2.075	8.30	11.91	M ²	81.00	964.71

Probable Estimate of civil works for Construction of Public Toilet (PT) at shelter for shelter less Toilet Block (PT) in ward no 25, under Balurghat Municipality.

[Rates taken from PWD Building & Sanitary plumbing Schedule] [Effect from 30th August 2018]

Sl. No.	Page No.	Item of work	No.	L(M)	B(M)	H(M)	Quantity	Total Quantity	Unit	Rate (Rs.)	Amount (Rs.)
36	P-104 Item-13 A (i) (3rd Corrigendum Page No-91)	a) M.S. or W.I Ornamental grill of approved designe joints continuously welded with M.S. W.I. Flats and bars of windows,railing etc. fitted and fixed with necessary screws and lugs in ground floor (Add extra @ 1% for each addi floor upto 4 th floor and @ 1.25% for each addi floor above 4th floor) (i) Grill weighing above 10 Kg/sqm and upto 16 Kg/sqm.									
		Window	4	0.600		0.600	1.44				
		16 Kg/sqm					1.44	23.04	M ²	100.21	2308.84
37	P/200 Item-I(a)	a) Priming one coat on steel or other metal surface with synthetic oil bound primer of approved quality including smoothening surfaces by sand papering etc. PWD Building Works schedule,									
		Window	4	0.600		0.600	1.44				
		Collapsible gate	1	2.550		2.150	5.48	6.92	M ²	29.00	200.68
38	P-200 Item-2(b)(iv)	(A) Painting with best quality synthetic enamel paint of approved make and brand including smoothening surface by sand papering etc. including using of approved putty etc. on the surface, if necessary:(b) On steel or other metal surface:(iv)Two coats (with any shade except white) PWD Building Works schedule,									
		Window	4	0.600		0.600	1.44				
		Collapsible gate	1	2.550		2.150	5.48	6.92	M ²	79.00	546.68
39	Page-66 Item-36 (A)	Supplying and laying true to line and level vitrified tiles of approved brand (size not less than 600 mm X 600 mm X 10 mm thick) in floor, skirting etc. set in 20 mm sand cement mortar (1:4) and 2 mm thick cement slurry back side of tiles using cement @ 2.91Kg./sqM or using polymerised adhesive (6 mm thick layer applied directly over finished artificial stone floor/Mosaic etc without any backing course) laid after a.....labour and all other incidental charges complete true to the manufacturer's specification and direction of Engineer-in-Charge. (White cement, synthetic adhesive and grout material to be supplied by the contr[e]i (I) With application slurry @1.75 kg/ Sq.m, 20 mm sand cement mortar (1:4) & 2 mm thick cement slurry at back side of tiles, 0.2 kg/ Sq.m white cement for joint filling with pigment.(A) Deep Colour & White PWD Building Works schedule,									
		Main floor	1	1.825		4.050	7.39				
		do	1	2.525		4.050	10.23				
		Door bott	2	1.000		0.250	0.50				
		Step trade	3	2.250		0.250	1.69				
		Riser	3	2.250		0.150	1.01				
		Side	2	0.750		0.150	0.23				
			2	0.500		0.150	0.15				
			2	0.250		0.150	0.08	21.28	M ²	1695.00	36069.6
		40	page-64, Item:35.(B.) (b).(ii) (3rd Corrigendum,Page 36)	Supplying, fitting & fixing 1st quality Ceramic tiles in walls and floors to match with the existing work & 4 nos. of key stones (10mm) fixed with araldite at the back of each tile & finishing the joints with white cement mixed with colouring oxide if required to match the colour of tiles including roughening of concrete surface, if necessary or by synthetic adhesive & grout materials etc. B) Wall Area of each tile above 0.09 Sq.m., ii) Other than Coloured decorative including white. PWD Building Works schedule,							
Inner wall	4			4.050		2.100	34.02				
do	2			1.825		2.100	7.67				
do	2			2.525		2.100	10.61				
do	1			1.075		2.100	2.26				
do	1			0.975		2.100	2.05				
do	1			0.850		2.100	1.79				
do	1			1.200		2.100	2.52				
do	2			0.450		2.100	1.89				
do	4			0.125		2.100	1.05				
Door side	4			0.250		2.100	2.10				
	1			0.250		2.100	0.53				
Deduction Door D	2			1.000		2.075	-4.15	62.34	M ²	1041.00	64895.94

Probable Estimate of civil works for Construction of Public Toilet (PT) at shelter for shelter less Toilet Block (PT) in ward no 25, under Balurghat Municipality.

[Rates taken from PWD Building & Sanitary plumbing Schedule] [Effect from 30th August 2018]

Sl. No.	Page No.	Item of work	No.	L(M)	B(M)	H(M)	Quantity	Total Quantity	Unit	Rate (Rs.)	Amount (Rs.)
41	Page-63 Item-33 (a)	Supplying, fitting & fixing granite slabs 15mm to 18 mm. thick with uniform texture & without decorative veins in columns, wall, fascia, rise etc. with 15 mm thick [avg] cement mortar (1:2) including making suitable arrangements to hold the stones properly by brass / copper hooks including pointing in cement mortar (1:2) (1 white cement : 2 marble dust) with admixture of pigment matching the stone shades all complete as per direction of the Engineer-in-charge including cost of all materials, labours, scaffolding, staging, curing and roughening of concrete surface complete. [Using cement slurry at back side of granite @ 4.4 kg/sq.m & white cement slurry for joint filling @ 1.8 kg/sq.m] In ground floor. (a) Area of each Granite slab 0.6 to 1.0 Square meter.									
		Urinal Partition	3	0.900		1.000	2.70	2.70	M ²	3570.00	9639.00
42	PWD, P-233, I-1(b) i	Supplying profiles of required section made of Aluminium Alloy Extrusions conforming to IS: 732-1983 and IS: 1285-1975; Anodized (with required film thickness and specified colour / natural) matt finished conforming to IS: 1868-1983 for fabrication of composite door, sliding & casement windows, partitions, formed of basic sections of any ISI embossed / certified make and brand as per direction of Engineer - In- Charge. (Payment will be made on finished length of the work).(A) In 10-12 Micron thickness Anodizing film I) Natural white, h) Louvered window. i) Top, bottom and side member.PWD Building Works schedule,									
			4	2.400			9.60	9.60	M	183.00	1756.8
43		ii) Louvered Section.									
			1	7.200			7.20	7.20	M	658.00	4737.6
44		iii) Cleat angle (Non-anodized).									
			1	6.480			6.48	6.48	M	263.00	1704.24
45	P-243, I-9	Supplying bubble free float glass of approved make and brand conforming to IS: 2835-1987.iv) 5mm thick coloured / tinted / smoke glass. PWD Building Works schedule,									
			4	0.600		0.600	1.44	1.44	M ²	585.00	842.40
46	P-268, I-17(e)	Painting block letters or digits in Black Japan or any approved paint as per direction. e)Size above 7.5 cm. and upto 10 cm. PWD Building Works schedule,									
			1			450.00	450.00	450.00	Nos	12.00	5400.00
47		Supplying and planting of different plants / trees (supplying well grown plants bushy and healthy, minimum height as specified i.e. exposed height including all leads and lifts, carriage, handling, manuring applying pesticide and fertilizer etc. i) Furcaria Veriegated 10 to 12 leaves in height 20-30 cm in earthen pot of size 25 cm									
			1			10.00	10.00	10.00	Nos	162.00	1620.00
48	Page -261, I-9 (x)	x) Ficus blakii (F. Vivicon) well branched (Bushy) of height 120cm - 135 cm in earthen pot of size 30cm.PWD Building Works schedule,									
			1			3.00	3.00	3.00	Nos	187.00	561.00
49	Page -261, I-9 (xxvi)	xxvi) Areca Palm 4 - 5 suckers of height 90 cm to 105 cm in earthen pots of size 25 cm.PWD Building Works schedule,									
			1			3.00	3.00	3.00	Nos	127.00	381.00
SANITARY AND PLUMBING WORKS											
50	Page No.79; item no - 3/b	Supplying, fitting and fixing Anglo-Indian W.C. in white glazed vitreous china ware of approved make complete in position with necessary bolts, nuts etc. (a) With 'P' trap (with vent)									
			1			4.00	4.00	4.00	Nos	3104.00	12416.00
51	P - 81. I-10/ii	Supplying, fitting and fixing Closet seat of approved make with lid and C.P. hinges, rubber buffer and brass screws complete .(b) Anglo Indian (i) Plastic (hallow type) White PWD S&P Schedule, page-81,item no 10.b.i (a) With 'P' trap (with vent)									
			1			4.000	4.00	4.00	Nos	485.00	1940.00
52	page.80, item no-6/(ii)	Supplying, fitting and fixing Flat back urinal (half stall urinal) in white vitreous chinaware of approved make in position with brass screws on 75 mm X 75 mm X 75 mm wooden blocks complete (ii) 470 mm X 280 mm X 340 mm PWD S&P Schedule.)									
			1			3.000	3.00	3.00	Nos	945.00	2835.00
53		Supplying fitting and fixing squatting plate with integrated flushing in white vitreous set in cement concrete (6:3:1) with jhama chips complete. Payment of concrete will be paid seperately) (I) 450 mm x 350 mm									
			1			2.000	2.00	2.00	Nos	881.00	1762.00
54	P- 36, I-2(2017)P&S	Supplying, fitting and fixing 10 litre P.V.C low down cistern conorming to IS specification with P.V.C fottings complete, C.I brackets including two coats of painting to bracket etc.									
			1			4.00	4.00	4.00	Nos	1015.00	4060.00

Probable Estimate of civil works for Construction of Public Toilet (PT) at shelter for shelter less Toilet Block (PT) in ward no 25, under Balurghat Municipality.

[Rates taken from PWD Building & Sanitary plumbing Schedule] [Effect from 30th August 2018]

Sl. No.	Page No.	Item of work	No.	L(M)	B(M)	H(M)	Quantity	Total Quantity	Unit	Rate (Rs.)	Amount (Rs.)
55	P-81, I-11(2017)P&S	Supplying, fitting and fixing 32 mm dia. Flush Pipe of approved make with necessary fixing materials and clamps complete. i) Polythene Flush Pipe.	1			4.000	4.00	4.00	Each	155.00	620.00
56	P- 81, I-12/a(2017)P &S	Supplying, fitting and fixing urinal flush pipe fitting of approved brand. (a) C.P. urinal flush pipe fittings range of one.	1			2	2.00	2.00	Nos	414.00	828.00
57	P-41, It 2 (ii)	Supplying, fitting and fixing white vitreous china best quality approved make wash basin with C.I. brackets on 75 mm X 75 mm wooden blocks, C.P. waste fittings of 32 mm dia., mending good all damages and painting the brackets with two coats of approved paint. (ii) 550 mm X 400 mm size PWD S&P Schedule,	1			2	2.00	2.00	Nos	2208.00	4416.00
58	P-41, It 3	Supplying fitting and fixing pedestal of approved make for wash basin (White) PWD S&P Schedule,	1			2	2.00	2.00	Nos	1497.00	2994.00
59	Page No.-43 Item No.-9-iii	Supplying,fitting and fixing approved brand P.V.C. CONNECTOR white flexible, with both ends coupling with heavy brass C.P. nut, 15 mm dia., (iii) 600 mm long .PWD S&P Schedule,	1			5	5.00	5.00	Nos	107.00	535.00
60	Page No.-43 Item No. 10-iv	Supplying,fitting and fixing approved brand 32 mm dia.P.V.C. waste pipe, with PVC coupling at one end fitted with necessary clamps. (iv) 1050 mm long each PWD S&P Schedule,	1			2	2.00	2.00	Nos	91.00	182.00
61	Page No.-3 Item No.-3 f,	(f) Hand Shower(Health Faucet) with 1mtr Flexible Tube with Wall Hook(Equivalent to Code No.573 & Model -ALLIED of Jaquar or similar). PWD S&P Schedule,	1			5	2.00	2.00	Nos	1251.00	2502.00
62	Page No.-6 Item No.-7-a i	(a) (i) Chromium plated Bib Cock short body (Equivalent to Code No. 511 & Model - Tropical / Sumthing Special of ESSCO or similar brand). PWD S&P Schedule,	1			7	5.00	5.00	Nos	539.00	2695.00
63	Page No.-6 Item No.-7-b-i	(b) (i) Chromium plated Stop Cock (Equivalent to Code No. 513(A) & 513(B) & Model - Tropical / Sumthing Special of ESSCO or similar. PWD S&P Schedule,	1			5	3.00	3.00	Nos	493.00	1479.00
64	Page No.-6 Item No.-7-d-i	Chromium plated angular Stop Cock with wall flange (Equivalent to Code No. 5053 & Model - Florentine of Jaquar or similar brand). PWD S&P Schedule,	1			5	3.00	3.00	Nos	815.00	2445.00
65	(P. No. - 45, Item. No. - 19(a)i	Supplying, fitting and fixing pillar cock of approved make. a) (i) CP Pillar Cock - 15 mm. (Equivalent to Code No. 507 & Model - Tropical / Sumthing Special of ESSCO or similar brand). (PwD Sanitary Plumbing Schedule 2017)	1			2	2.00	2.00	Nos	555.00	1110.00
66	Page No.-12 Item No.-19 i(a), PWD,VOL-II, 2017-18	Supplying, fitting and fixing PVC pipes of approved make of Schedule 80 (medium duty) conforming to ASTM D - 1785 and threaded to match with GI Pipes as per IS : 1239 (Part - I). with all necessary accessories, specials viz. socket, bend, tee, union, cross, elbo, nipple, longscrew, reducing socket, reducing tee, short piece etc. fitted with holder bats clamps, including cutting pipes, making threads,fitting, fixing etc. complete in all respect including cost of all necessary fittings as required, jointing materials and two coats of painting with approved paint in any position above ground. (Payment will be made on the centre line measurements of total pipe line including all specials. No separate payment will be made for accesories, specials. Payment for painting will be made seperately) (a) For Exposed Work PVC Pipes, 25 mm	1			25	25.00	25.00	Mtr	177.00	4425.00
67	Page No.-12 Item No.-19	(a) (a) For Exposed Work PVC Pipes, 15 mm	1			10	10.00	10.00	Mtr	101.00	1010.00
68	Page No.-12 Item No.-19	(b) For Concealed Work PVC Pipes, 15 mm	1			10	10.00	10.00	Mtr	137.00	1370.00
69	PWD S&P Schedule, P-5 It-5,vii,	Supplying and fitting fixing of gunmetal wheel valve of approved brand and make tested to 21 Kg per sq. cm. 25 mm dia(E5)	1			2	2.00	2.00	Nos	778.00	1556.00
70	page.37,ite m no-6 (b)	Supplying P.V.C. water storage tank of approved quality with closed top with lid (Black) - Multilayer (b) 1000 litre capacity, PWD S&P Schedule,	1			2	2.00	2.00	Nos	5128.00	10256.00
71	page.37,ite m no-10 (i)(a)	Labour for hoisting plastic water storage tank. (i) Upto 1500 litre capacity. (a) Upto 1st story from G.L. PWD S&P Schedule,	1			2	2.00	2.00	Nos	96.00	192.00

Probable Estimate of civil works for Construction of Public Toilet (PT) at shelter for shelter less Toilet Block (PT) in ward no 25, under Balurghat Municipality.

[Rates taken from PWD Building & Sanitary plumbing Schedule] [Effect from 30th August 2018]

Sl. No.	Page No.	Item of work	No.	L(M)	B(M)	H(M)	Quantity	Total Quantity	Unit	Rate (Rs.)	Amount (Rs.)
72	(P. No. - 38, Item. No. - 13)	Labour for punching hole in plastic water storage tank upto 50 mm dia. PWD S&P Schedule,	1			4	4.00	4.00	Nos	19.00	76.00
73	Page No.-68 Item No. 23,(A)(i)(b)	Supply of UPVC pipes (B Type) & fittings conforming to IS-13592- 1992.(A) (i) Single Socketed 3 Meter Length, (b) 110 mm PWD S&P Schedule,	1			30	30.00	30.00	Mtr	292.00	8760.00
74		(B) Fittings	1			8	8.00	8.00	Nos	85.00	680.00
75		(ii) Plain Tee, (b) 110 mm	1			12	12.00	12.00	Nos	85.00	1020.00
76		(iii) Door Tee, (b) 110 mm	1			10	10.00	10.00	Nos	195.00	1950.00
77		ix) Bend 45°, (b) 110 mm	1			10	10.00	10.00	Nos	89.00	890.00
78		xi) Door Bend (T.S.), (b) 110 mm	1			7	7.00	7.00	Nos	147.00	1029.00
79		xvi) Pipe Clip, (b) 110 mm	1			30	30.00	30.00	Nos	21.00	630.00
80		xvii) W.C. Connector (150 mm long) 125 X 110(W/WC Ring) 75 mm	1			4	4.00	4.00	Nos	142.00	568.00
81		xxxi) Plain Floor Trap with Top tile & Strainer 75 mm	1			7	7.00	7.00	Nos	144.00	1008.00
82		L) Rubber Ring, (b) 110 mm	1			15	15.00	15.00	Nos	17.00	255.00
83		C)Rubber Lubricant 500 ML	1			1	1.00	1.00	Nos	187.00	187.00
84		D)Solvent Cement 250 ML	1			1	1.00	1.00	Nos	103.00	103.00
85	(P. - 74, Item. No. - 24 (B))	Labour for fitting and fixing U.P.V.C. pipes for above ground work including cost of jointing materials etc. fitting and fixing all necessary specials, cutting pipes, cutting holes in total pipeline including specials. (B) Under ground, (ii) 110 mm dia. PWD S&P Schedule,	1			25	25.00	20.00	Mtr	57.00	1140.00
86	(P. - 212, Item. No. - 21 (A)(i), (B),(c),(i) & (B), (d),(i),	Supplying, fitting & fixing UPVC pipes A- Type and fittings conforming to IS:13592-1992 with all necessary clamps nails, including making holes in walls, floor etc. cutting trenches in any soil through masonry concrete structures etc if necessary and mending good damages including joining with jointing materials (Spun Yarn, Valamoid/Bitumen/M-Seal etc) complete. A) UPVC Pipes: (i) 75 mm. Dia.	1			30	30.00	20.00	Mtr	188.00	3760.00
87		B) UPVC Fittings: c) Bend 87.5 degree (i) 75 mm. Dia.	1			6	6.00	6.00	Each	95.00	570.00
88		B) UPVC Fittings: d) Shoe (i) 75 mm. Dia.	1			2	2.00	2.00	Each	78.00	156.00
89	PWD S&P Schedule, S.P.87,Item No-1/(i), 7th Corrigenda Volume ii	Constructing Inspection pit of inside measurement 600mm X 600mm X upto 600mm (depth) with 250 mm thick 1st. class brick work in cement mortar (1:4) on all sides, bottom of the pit consisting of 100 mm thick cement concrete (1:3:6) with stone chips over a layer of jhama brick flat soling, 15 mm thick (1:4) cement plaster to inside walls and out-side walls upto G.L. and 20 mm.thick (1:4) plaster to bottom of the pit, providing necessary invert with cement concrete (1:3:6) with stone chips as per direction, neat cement finishing to entire internal surfaces, top of the pit covered with 100 mm thick R.C.C. slab (1:1.5:3) with stone chips and necessary reinforcements upto 1% and shuttering including 6 mm thick cement plaster (1:4) in all external surfaces of the slab and one 560 mm dia. R.C.C. manhole cover of approved make supplied, fitted and fixed in the slab with necessary fittings, necessary earthwork in excavation in all sorts of soil, filling sides of the pit with earth and removing spoils after work complete in all respect with all costs of labour and materials. i) With Pakur variety (Other than SAIL/TATA/RINL).	1			2	3.00	3.00	Each	6627.00	19881.00

Probable Estimate of civil works for Construction of Public Toilet (PT) at shelter for shelter less Toilet Block (PT) in ward no 25, under Balurghat Municipality.

[Rates taken from PWD Building & Sanitary plumbing Schedule] [Effect from 30th August 2018]

Sl. No.	Page No.	Item of work	No.	L(M)	B(M)	H(M)	Quantity	Total Quantity	Unit	Rate (Rs.)	Amount (Rs.)
90	PWD S&P Schedule, S.P.88, Item No-3(ii)(A) 7th Corrigenda Volume ii	Construction of septic tank of different capacities as per approved drawing with 1st class brick work in cement mortar (1:4) including two 560 mm dia. R.C.C. manhole cover (heavy type) of approved make supplied, fitted and fixed in the 100mm thick R.C.C (1:1.5:3) top slab with necessary fittings, 20mm thick cement plaster (4 : 1) with neat cement finish to the internal surfaces and 15 mm thick cement plaster (4 : 1) to outside wall upto 200 mm below G.L floor finished with 25 mm thick grey artificial stone over 100 mm thick R.C.C(1:1.5:3) bottom slab including supplying, fitting and fixing all necessary specials, fittings, S.W. tees, C.I. foot rest etc. including excavation earth in all sorts of soil, shoring, bailing out and pumping out water as necessary, ramming, dressing the bed and refilling the sides of the tanks with earth, removing spoils, filling up the chamber with clear water, removing foreign materials from the chamber andflooring is to be done with admixture of water proofing compound @ 0.5% by weight of cement with all costs of labour and materials. (ii) For 20 users A) With Pakur variety. (JSW/JSPL/SHYAM/SRMB/ELECTROSTEEL/SSL)	1			1	1.00	1.00	Each	45312.00	45312.00
91	S.P.89, Item No-4 7th Corrigenda Volume ii	Construction of circular soak well 2.5 metre deep in all types of sandy soils with dry brick work upto 1.6 metre from the bottom having 150 mm intermediate cement brick work (1:4) band all round and cement brick work (1:4) upto 0.90 metre from top with 20mm thick cement plastering (1:4) to inside face upto the depth of cement brick work, 15mm thick cement plaster (1:4) on outer face from top of the well upto G.L. and 6 mm thick cement plaster (1:4) on top of the R.C.C. cover slab including filling bottom 1.00 metre of inside of the well with brick metal (50 mm to 63 mm size) including R.C.C. cover slab of 100 mm thick with cement conc (1:1.5:3) with stone chips with necessary reinforcement and shuttering including one 560 mm dia. R.C.C. manhole cover (heavy type) of approved make supplied, fitted and fixed in the cover slab with necessary fittings, making necessary arrangements for pipe connections, excavation of well ...With 250 mm thick dry brick work and 250 mm thick cement brick work (1:6) and 1.00m inside dia. (Other than SAIL/TATA/RINL)	1			1	1.00	1.00	Each	15662.00	15662.00
92	PWD S&P Schedule, p No 82 I No-22	Supplying, fitting and fixing towel rail with two brackets. (a) C.P. over brass (ii) 25 mm dia. and 600 mm long	1			2	2.00	2.00	Each	430.00	860.00
93	PWD S&P Schedule, P 81, It-15(ii)	Supplying, fitting and fixing bevelled edged mirror 5.5 mm thick silver red as per I.S. 3438 / 1965 together with brass C.P. hinges. (ii) 600 mm X 450 mm	1			2	2.00	2.00	Each	484.00	968.00
94	PWD S&P Schedule, P 82, It-18(b)	Supplying, fitting and fixing soap holder. (b) Fibre glass Sanitary and plumbing work schedule	1			7	4.00	2.00	Each	58.00	116.00
95	PWD S&P Schedule, P 81, It-16(i)(a)	Supplying, fitting and fixing glass shelf with aluminium guard rails. (a) Ordinary type with 5.5 mm sheet glass (i) 450 mm X 125 mm	1			2	2.00	2.00	Each	341.00	682.00
TOTAL											685400.72
ADD 18% GST											123372.13
TOTAL											808772.85
ADD LABOUR CESS 1%											8087.73
TOTAL											816860.58
ADD 3% CONTINGENCY											24263.19
GRAND TOTAL Rs.											841123.77
Say Rs.											841124.00

S.A.E.
S.A.E.
Balurghat Municipality

Asst. Engr
Assistant Engineer
Balurghat Municipality

Chairman
Chairman
Balurghat Municipality

Vetted

20.8.2018
Junior Engineer
Balurghat Sub-Division
Under Malda Division
Municipal Engineering Directorate
Deptt. of UD & MA
Govt. of West Bengal

May be Vetted
Asst. Engr
Assistant Engineer
Balurghat Sub-Division
Under Malda Division
Municipal Engineering Directorate
Deptt. of UD & MA
Govt. of West Bengal

29/1/2018
Executive Engineer
MALDA DIVISION
Municipal Engineering Directorate
Deptt. of UD & MA
Govt. of West Bengal

MODEL DRAWING FOR CONSTRUCTION OF PUBLIC TOILET (PT) AT SHELTER FOR SHELTER LESS IN WARD NO 25, UNDER BALURGHAT MUNICIPALITY.

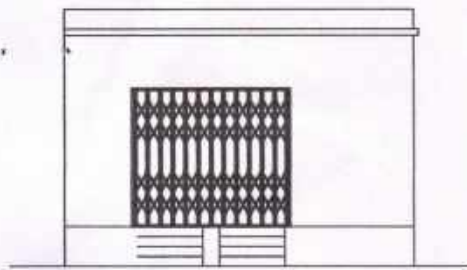

FRONT ELEVATION

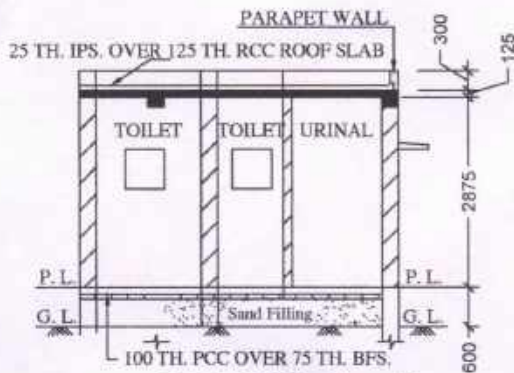

SECTION - 'A - A'

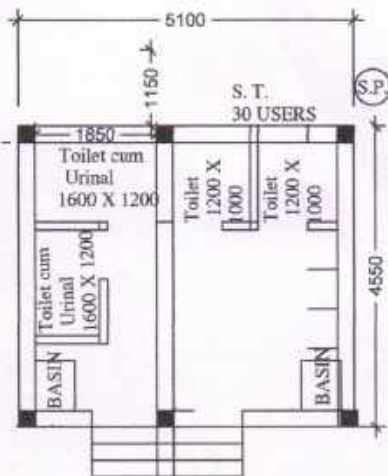

PLAN

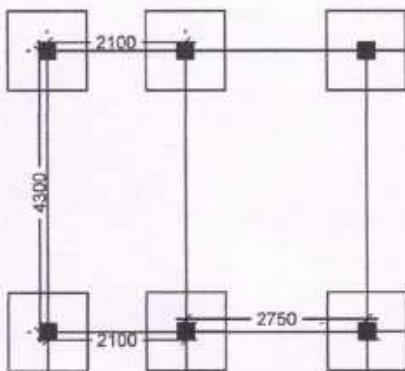

LAYOUT PLAN

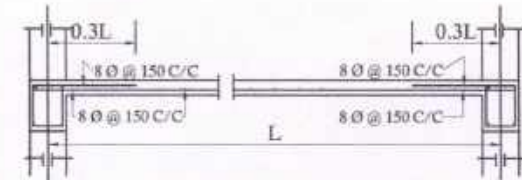
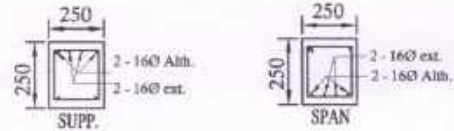

Details Of R.C.C Roof Slab & Beam

(SCALE - 1 : 25)

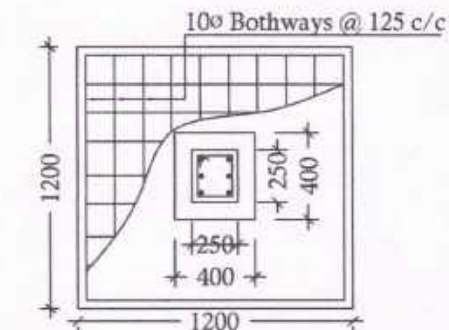
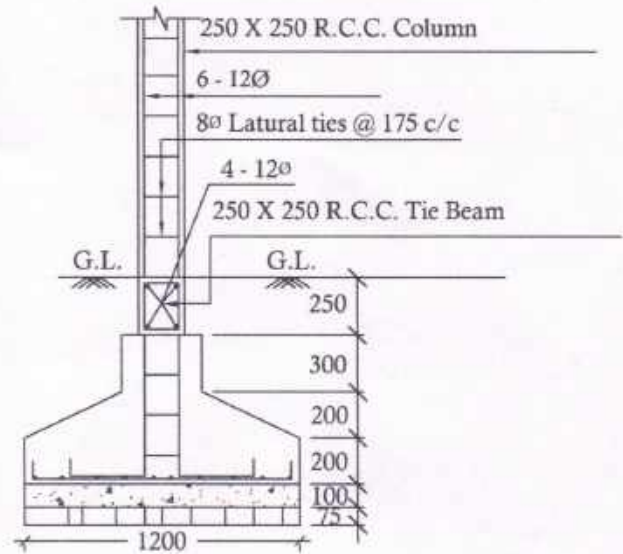

DETAILS OF R. C. C COLUMN

(SCALE - 1 : 25)

S.A.E.
S.A.E.
Bahurghat Municipality

11/26
Assistant Engineer
Bahurghat Municipality

Chairman
Chairman
Bahurghat Municipality