

KONNAGAR MUNICIPALITY ②

Subject:- ESTIMATE FOR ELECTRICAL WORK OF PUBLIC/COMMUNITY TOILET, TOILET 2 NOS URINAL 3 NOS AT KONNAGAR MUNICIPALITY PLAY GROUND WARD NO. - 28 UNDER KONNAGAR MUNICIPALITY OF WEST BENGAL [ASPIRATIONAL PARAMETER] KONNAGAR, HOOGHLY. (MODEL : F)

Sl.No	Description of work	Quantity	Unit	Rate	Amount	Remarks
1	Distribution wiring in 2 x 22/0.3 (1.5 sqmm) single core stranded 'FR' PVC insulated & unsheathed copper wire (Brand approved by EIC) in 20mm size PVC rigid conduit 'FR' (Precision make), with 1x22/0.3 (1.5 sqmm) single core stranded 'FR' PVC insulated & unsheathed copper wire for ECC, to light/fan/call bell points with Piano Key type switch fixed on MS CRC sheet metal (16 SWG) switch board cum JB on wall complete with 2 no. suitable size "Ph & N" copper bar incl. bakelite/Perspex (wall matching color) top cover 3 mm thick and incl. 175mm x 100mm x 65mm inspection box, making earthing attachment, painting the MS box and mending good the damages to original finish. Average run 5 mtr. PWD Schedule Page No-E-14 Item No-2a	4 11	Nos	612.00	2448.00 6732.00	
2	Distribution wiring in 1.1 KV grade 22/0.3 (1.5 sqmm) single core stranded 'FR' PVC insulated & unsheathed copper wire (Brand approved by EIC) in 20mm size PVC rigid conduit 'FR' (Precision make), with 1.1 KV grade 1 x 22/0.3 (1.5 sqmm) single core stranded 'FR' PVC insulated & unsheathed copper wire as ECC, to 5A 3 pin flush type plug socket & Piano Key type switch fixed on MS CRC sheet metal (16 SWG) switch board cum JB on wall incl. bakelite/ Perspex (wall matching color) top cover 3 mm thick and incl. painting the MS box and mending good the damages to original finish On Board (only for pay counter) PWD Schedule Page No-E-15; I-4a	2 1	Nos	67.00	134.00 67.00	
3	Supplying and fixing 240V 32A Double Pole AC Type 30mA RCCB. (Complete Set) (ISI marked) [Make- Legrand] (Cat No 4113/95) Legrand Page No-92	1	No	5942.00	5942.00	
4	Distribution wiring in 1.1 KV single core stranded 'FR' PVC insulated & unsheathed copper wire (Brand approved by EIC) in 20mm size PVC rigid conduit 'FR' (Precision make) incl. necy. fittings as required 2 x 36/0.3 (2.5 sqmm) + 1 x 22/0.3 (1.5 sqmm) ECC PWD Schedule Page No-E-14 Item No-1a(ii)	95 10	Mtr.	119.00	11305.00 1190.00	
5	Supplying and fixing double-door SPN MCB Distribution Board with IP-42/43 protection, concealed in wall after cutting the wall & mending good the damages to original finish incl. Inter connection with suitable size of copper wire and neutral link & provision for earthing attachment. a) For (2+4 way) (Make -Havells) (upto 6 seats) PWD Schedule Page No-D-9; Item No-13	1	No	935.00	935.00	
6	Supplying and fixing 240/415 V MCB of Breaking capacity 10kA & C characteristics on din rail of existing DBs and necessary connection 6-32A SP MCB (Make -Havells) PWD Schedule Page No-D-6; Item No-7	2 4	Nos	168.00	672.00 336.00	
TOTAL C/F Rs.					21100.00	

Sl.No	Description of work	Quantity	Unit	Rate	Amount	Remarks
TOTAL B/F Rs.					21100.00	
7	Supplying and fixing 240/415 V MCB Isolator on din rail of existing DBs and necessary connection. 32A DP MCB Isolator (Make -Havells) PWD Schedule Page No-D-5;Iteam No-6	1	No	208.00	208.00	
8	Supply of TMC501 conventional industrial batten (Philips make) LED Tube,model no- TMC501 P1xT-LED 22W P3241 WB I & WD schedule P-113, I- 5:3 F.22	2 3	Nos	451.00	902.00 1353.00	
9	Fixing only single/twin fluroscent light fitting complete with all accessories directly on wall/ceiling by screws etc. PWD Schedule Page No-C-2;Iteam No-14a	2 3	Nos	86.00	172.00 258.00	
10	Supply & fixing Bulk head light fittings with die cast aluminium housing frosted/clear glass on wall/ceiling incl S/F 9 watt LED Lamp complete set. [Make - Havells] PWD sch - Page-D-13, I-23	2 3	Nos	644.00	1288.00 1932.00	
11	Supply & fixing smart bright street light complete with all accessories to be fixed from the wall of building or on pole incl. making holes /providing clamping arrangement & necy. GI reducer as required.S&F 40 mm GI Pipe 1.5 mtr average length & s&f necy length of 1.5 sqmm pvc insulated single core copper wire & making connections as required & mending good damages incl wall paingting. (30 Watt) (Make - Bajaj) WB I&WD sch P-111, I-f.9.0.2	1	No	3016.00	3016.00	
12	Supply of 12" domestic metal exhaust fan 9" (225mm) SWEEP. TRANS AIR - (for 4 seats)or 230V 50 Hz (Model- Trans Air 12" Grey)(above 4 seats)(Make-Crompton/Havells /Bajaj) UD & MA schedule P-14, I-5	2 3	Nos	1863.00	3726.00 5589.00	
13	Fixing only exhaust fan after making hole in wall and making good damages and smooth cement finish etc. as practicable as possible and providing necy. length of PVC insulated wire and making connection for exhaust of following diameter: 22.5 cm (9")or 30 cm (12") PWD Schedule Page No-C-4;Iteam No-28(b)	2 3	Nos	247.00	494.00 741.00	
14	Fixing only louver shutter/cowl on wall with necy. bolts & nuts (6 mm dia x 62 mm long) For 22.5 cm(9") Exhaust fan or For 30 cm(12") Exhaust fan PWD Schedule Page No-C-4;Iteam No-28(b)	2 3	Nos	82.00	164.00 246.00	
15	S/F 240V 25A Modular type starter (brand approved by EIC)with 25 A. Modular switch DP MCB (C-Curve)and 4 Module G.I. Moduar type switch board with 4 Module Top Cover Plate flushed in wall incl. S/F switch board and Cover Plate and making necy. Connections with PVC Copper wire and earth connectivity wire etc. as per schedule [for Pump] [PWD Schedule Page No-E-19, Item No-17]	1	No	784.00	784.00	
16	Supply of 240V A.C Ceiling Fan (48" sweep,1200 mm complete)[Make-Crompton [for counter only] (UD & MA schedule P- 23, I- 70)		Each	2283.00	0.00	
17	Fixing only Ceiling Fan PWD sch P- C-3, I-21(a)		Each	66.00	0.00	
TOTAL C/F Rs.					31854.00	

Sl.No	Description of work	Quantity	Unit	Rate	Amount	Remarks
TOTAL B/F Rs.					33639.00	
18	Supply & Fixing 240 V, 16/20 A Piano key type switch (Brand approved by EIC) on sheet metal switch board incl. S & F 100x100x65mm MS (16SWG) switch board and bakelite/perspex top cover of 3mm thick by Brass screws after making housing for switch by cutting bakelite/perspex cover and making necessary connections as required. (For Hand Dryer machine) PWD sch P- E-6, I-17(b)	2	No	201.00	402.00	
19	Supply and Fixing of 2 mm Polyvinyl glow sign board made of 22 SWG GI sheet box with 1"X1" aluminum channel for fixing the vinyl board after necessary cutting the letter as required & s\ f LED tube light fittings along with all accessories. (16 sqft @495.00/sqft) UD & MA schedule P-14, I-4	1	No	7920.00	7920.00	
20	Earthing installation by GI earth Spike (1830 X 20 mm) including 8SWG GI EarthWire & GI nuts, bolts, washer etc.	1	No	450.00	450.00	
				Total Rs.	42411.00	37986.00
				Add 9% CGST Rs.	3816.99	3418.74
				Add 9% SGST Rs.	3816.99	3418.74
				Total With GST (A) Rs.	50044.98	44823.48
				Cess@1% Rs.	500.45	448.23
				Total Rs.	50545.43	45271.71
	Contingency Amount on "A"			Contingency@3% Rs.	1501.35	1344.70
	(Total+GST)=Rs:			Total Rs.	52046.78	46616.41
				Say Rs.	52047.00	

Say Rs. 46,616.00

***** Rupees ~~Fifty Two Thousand Forty Seven Only.~~

Bhoro.

SAE
Konnagar Municipality

Sulag no Mukherjee
Finance Officer
Konnagar Municipality

V Chandra
Executive Officer
Konnagar Municipality

[Signature]
Chairman
Konnagar Municipality

Tufan Nandy

[Signature]
Junior Engineer 04.02.25
Electrical & Mechanical Division
SUDA

[Signature]
ASSISTANT ENGINEER
ELECTRICAL & MECHANICAL DIVISION
SUDA

Technically Vetted Rs. 46,616.00
(Rupees Forty six thousand six hundred sixteen only)

[Signature]
Executive Engineer (E/M)
O/O the Secretary M.E. Dte.
Government of West Bengal

MODEL DRAWING FOR CONSTRUCTION OF C. T./P.T.
TOILET SEATS 2 NOS URINAL 3 NOS AT KONNAGAR
MUNICIPALITY PLAY GROUND , WARD - 18,
UNDER KONNAGAR MUNICIPALITY
MODEL NO.- F

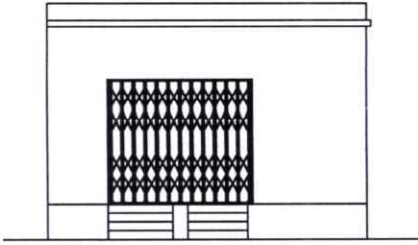

FRONT ELEVATION

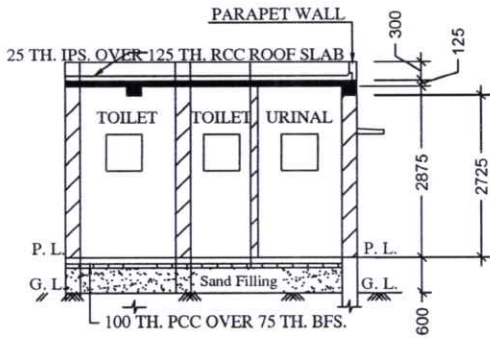

SECTION - 'A - A'

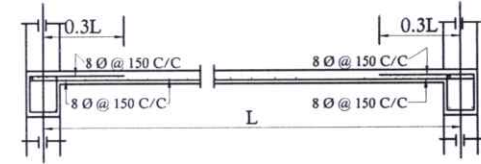
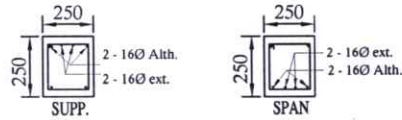

Details Of R.C.C Roof Slab & Beam
(SCALE - 1 : 25)

BHLP → 03

EF → 03

TL → 03

OL → 01

G.S.B → 01

11' pts

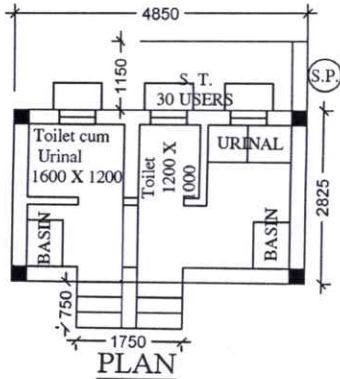

PLAN

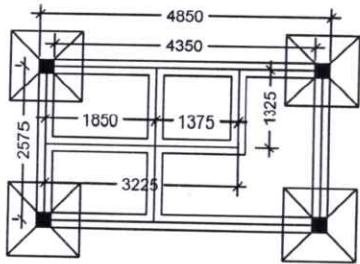
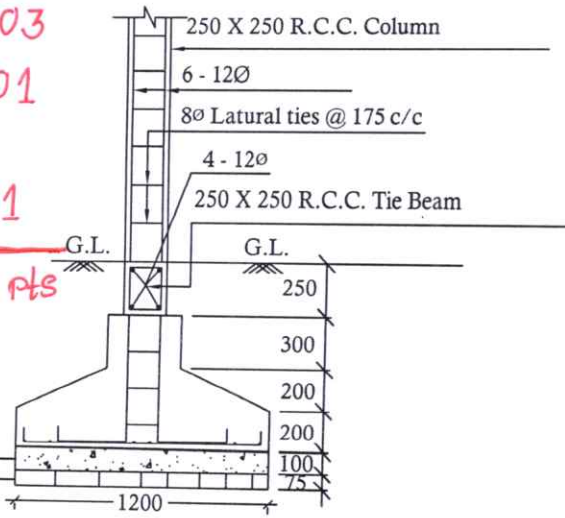

COLUMN LAYOUT PLAN

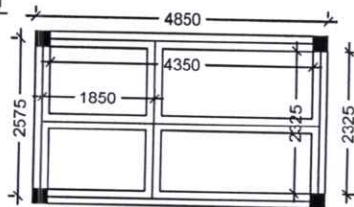

LAYOUT ROOF BEAM PLAN

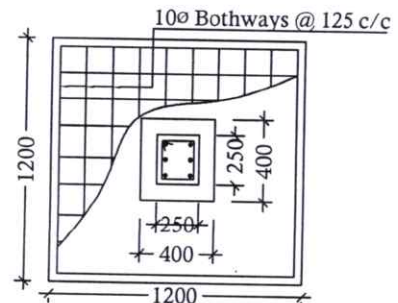

DETAILS OF R. C. C COLUMN
(SCALE - 1 : 25)