

**BANKURA MUNICIPALITY**

NAME OF WORK:- CONSTRUCTION OF TOILET BLOCK (CT/PT) MODEL NO - G ELECTRICAL WORKS

TOILET SEATS -4 NOS AND URINAL- 5 NOS (Haritaki Bagam,

[ASPIRATIONAL PARAMETER] **Kemduadihi, Ward-15)**

\* As per PWD & I & WD schedule district charges will be applicable on PWD & I & WD schedule items

\* No district charges will be applicable on non-schedule items

Sl No.	Item Description	Unit	Quantity	Rate	Amount	Remarks
1	Distribution wiring in 1.1 KV grade 2x22/0.3 (1.5 sqmm) single core stranded 'FR' PVC insulated & unsheathed copper wire (Brand approved by EIC) in suitable size PVC casing-capping (Precision make) with 1x22/0.3 (1.5 sqmm) single core stranded 'FR' PVC insulated & unsheathed copper wire for ECC, incl. necy. PVC clips, fittings etc. to light/fan/call bell point with piano key type switch (Anchor make) fixed on sheet steel fabricated switch board with Perspex/bakelite top cover on wall incl. necy. connections and making earthing attachment and mending good damages to building works. [PVC casing-capping and Switch board both on surface] <b>(Road Conduit)</b> (PWD sch P- E-14, I-2,a)	Point	<del>19</del> 14	Rs. <del>605.85</del> 642.60	Rs. <del>11,511.15</del> 8996.40	District charges will be applicable for different districts on Rs. 577/-
	Average run 5 mtr					
2	Distribution Wiring in 1.1 KV grade 2x22/0.3 (1.5 sqmm) single core stranded 'FR' PVC insulated & unsheathed copper wire (Brand approved by EIC) in suitable size PVC casing-capping (Precision make) with 1x22/0.3 (1.5 sqmm) single core stranded 'FR' PVC insulated & unsheathed copper wire for ECC, incl. necy. PVC clips, fittings etc. to 5A 3 pin flush type plug socket with piano key type switch (Anchor make) fixed on sheet steel fabricated CRC MS switch board with bakelite/perspex (wall matching color) top cover of 3 mm thick flushed in wall by housing the board after cutting brick wall incl. necy. connection making earthing attachment, painting and mending good damages to building works [PVC casing-capping and plug box both on surface] <b>(Road Conduit)</b> (PWD Schedule Page No-E-13; I-6(a))	Point	<del>19</del> 1	Rs. 70.35	Rs. <del>1,336.65</del> 70.35	District charges will be applicable for different districts on Rs. 67/-
3	Supplying and fixing <del>Sheet steel Main Switches on flat iron frame</del> on wall 240V DP with fuse on L&N 32 A [Make- Havells] <b>30 mA RCMB (Complete)</b> <b>(Road Conduit)</b> (PWD Schedule Page No-D-1 Item No-1(a))	Nos	1	Rs. <del>1,340.85</del> 5942.00	Rs. <del>1,340.85</del> 5942.00	District charges will be applicable for different districts on Rs. 177/-
4	Wiring in 1.1 KV grade single core stranded 'FR' PVC insulated & unsheathed copper wire (Brand approved by EIC) of following sizes in 25mm PVC casing-capping (Precision make) incl. necy. PVC clips, fittings etc. 2 x 36/0.3 (2.5 sqmm) + 1 x 22/0.3 (1.5 sqmm) ECC (PWD Schedule Page No-E-14 Item No-1(a))	mtr	<del>95</del> 16	Rs. <del>107.10</del> 124.95	Rs. <del>10,174.50</del> 1999.20	District charges will be applicable for different districts on Rs. 102/-
5	Supplying and fixing MCB SS enclosure with IP-20/30 protection, powder coated provision for two/four pole MCB, concealed in wall after cutting the wall & mending good the damages to original finish incl. painting, connection & provision for earthing attachment (4-way MCB enclosure) <b>incl 240V 40A DP MCB Isolator</b> (PWD SCH P-D-9 Item-11 (PwD-D/6, 2/6) (Havells))	No	<del>2</del> 1	<del>(935+208)</del> =1143+5% Rs. 331.80 =1200.15	Rs. <del>663.60</del> 1200.15	District charges will be applicable for different districts on Rs. 316/-
6	Supplying and fixing 240/415 V MCB of Breaking capacity 10KA & C characteristics on din rail of existing DBs and necessary connection 6-32A SP MCB (Make -Havells) (PWD Schedule Page No-D-6; Item No-7)	Nos	<del>3</del> 4	Rs. 176.40	Rs. <del>529.20</del> 705.60	District charges will be applicable for different districts on Rs. 168/-

Sl No.	Item Description	Unit	Quantity	Rate	Amount	Remarks
7	Supply of TMC501 conventional industrial batten philips LED Tube,model no- TMC501 P1xT-LED 22W P3241 (WB I & WD schedule P-113, I- 5:3 F.22)	Nos	4	Rs. <del>473.55</del> 660.02	Rs. <del>1,894.20</del> 1840.08	District charges will be applicable for different districts on Rs. 451/-
8	Fixing only single/twin fluroscent light fitting complete with all accessories directly on wall/ceiling by screws etc.. [PWD Schedule Page No-C-2;Item No-14a]	Nos	4	Rs. 90.30	Rs. 361.20	District charges will be applicable for different districts on Rs. 86/-
9	Supply & fixing Bulk head light fittings with die cast aluminium housing frosted/clear glass on wall/ceiling incl S/F 9 watt LED Lamp complete set. [Make - Havells] (PWD sch - Page--D-13, I-23)	Nos	4	Rs. <del>597.45</del> 672.45	Rs. <del>2,389.80</del> 2689.80	District charges will be applicable for different districts on Rs. 569/-
10	Supply & fixing smart bright street light complete with all accessories to be fixed from the wall of building or on pole incl. making holes /providing clamping arrangement & necy. GI reducer as required.S&F 40 mm GI Pipe 1.5 mtr average length & s&f necy length of 1.5 sqmm pvc insulated single core copper wire & making connections as required & mending good damages incl wall painting. (30 Watt) (Make - Bajaj) [WB I&WD sch P-513, I-f.9.0.2]	Nos	<del>2</del> 1	Rs. <del>3,166.80</del> 3076.32	Rs. <del>6,333.60</del> 3076.32	District charges will be applicable for different districts on Rs. 3016/-
11	Supply of <del>12"</del> domestic metal exhaust fan 230V 50 Hz (Model- Trans Air <del>12"</del> Grey) ( Make- Crompton/Havells/Bajaj) (9") (UD & MA schedule P-14, I-5)	Nos	<del>7</del> 3	Rs. <del>2,093.00</del> 1863.00	Rs. <del>14,651.00</del> 5589.00	No district charges
12	Fixing only exhaust fan after making hole in wall and making good damages and smooth cement finish etc. as practicable as possible and providing necy. length of PVC insulated wire and making connection for exhaust of following diameter: <del>30 cm (12")</del> (9") [PWD Schedule Page No-C-4;Item No-28(b)]	Nos	<del>7</del> 3	Rs. <del>345.45</del> 259.35	Rs. <del>2,418.15</del> 778.05	District charges will be applicable for different districts on Rs. 329/-
13	Fixing only louver shutter/cowl on wall with necy. bolts & nuts (6 mm dia x 62 mm long) For <del>30 cm (12")</del> Exhaust fan (9") [PWD Schedule Page No-C-4;Item No-28(b)]	Nos	<del>7</del> 3	Rs. <del>115.50</del> 86.10	Rs. <del>808.50</del> 258.30	District charges will be applicable for different districts on Rs. 110/-
14	S/F 240V 25A Modular type starter (brand approved by EIC)with 25 A. Modular switch DP MCB (C-Curve)and 4 Module G.I. Moduar type switch board with 4 Module Top Cover Plate flushed in wall incl. S/F switch board and Cover Plate and making necy. Connections with PVC Copper wire and earth connectivity wire etc. as per schedule [for Pump] [PWD Schedule Page No-E-19, Item No-17] (Please follow in details)	Nos	<del>2</del> 1	Rs. <del>823.20</del>	Rs. <del>1,646.40</del> 823.20	District charges will be applicable for different districts on Rs. 784/-
15	Supply of 240V A.C Ceiling Fan ( 48" sweep complete) [Make-Crompton [ for counter only] (1200 mm) (UD & MA schedule P- 23, I- 70)	Each	<del>2</del> 1	Rs. 2,283.00	Rs. <del>4,566.00</del> 2283.00	No district charges
16	Fixing only Ceiling Fan [PWD sch P- C-3, I-21(a)]	Each	<del>2</del> 1	Rs. 69.30	Rs. <del>138.60</del> 69.30	District charges will be applicable for different districts on Rs. 66/-
17	Supply & Fixing 240 V, 20 A Piano key type switch (Brand approved by EIC) on sheet metal switch board incl. S & F 100x100x65mm MS (16SWG) switch board and bakelite/perspex top cover of 3mm thick by Brass screws after making housing for switch by cutting bakelite/perspex cover and making necessary connections as required [PWD sch P- E-6, I-17(b)]	Each	2	Rs. 211.00	Rs. 422.00	District charges will be applicable for different districts on Rs. 201/-

Sl No.	Item Description	Unit	Quantity	Rate	Amount	Remarks
18	Supply and Fixing of 2 mm Polyvinyl glow sign board made of 22 SWG GI sheet box with 1"X1" aluminum channel for fixing the vinyl board after necessary cutting the letter as required & s/f LED tube light fittings along with all accessories. (16 sqft @495.00/sqft) (UD & MA schedule P-14, I-4)	Nos	1	Rs. 7,920.00	Rs. 7,920.00	No district charges
19	Earthing installation by GI earth Spike (1830 X 20 mm) including 8SWG GI Earth Wire & GI nuts, bolts, washer etc.	Nos	1	Rs. 450.00	Rs. 450.00	No district charges
				Total	Rs. 69,555.40	48473.95
				Add 18% GST	Rs. 12,519.97	8185.31
				Total With GST (A)	Rs. 82,075.37	53659.26
				Cess@1%	Rs. 820.75	536.59
				total	Rs. 82,896.13	54195.85
	Contingency Amount on "A"			Contingency@3%	Rs. 2,462.26	1609.77
	(Total+GST)=Rs:			Total	Rs. 85,358.39	55805.62
			Say	Total =	Rs. 85,358.00	+
	<del>*(if require)</del> (+) Service Connection Charges			Rs. 5000.00	Rs. 5,000.00	5000.00
				Grand Total	Rs. 90,358.00	60805.62
(Rupees Ninety Thousand Three Hundred Fifty Eight Only)						

Say Rs. 60,806.00

*[Signature]*  
27/12/24  
S.A.E.  
Bankura Municipality

*[Signature]* 27/12/24  
Chairperson  
Bankura Municipality

Technically Vetted Rs. 60,806/-  
(Rupees Sixty thousand eight hundred Six only)

*[Signature]*  
22-01-25  
Junior Engineer  
Electrical & Mechanical Division  
SUDA

*[Signature]*  
22.1.25  
ASSISTANT ENGINEER  
ELECTRICAL & MECHANICAL DIVISION  
SUDA

*[Signature]* 22/1/25  
Executive Engineer (E/M)  
O/O the Secretary M.E. Dte.  
Government of West Bengal

MODLE DRAWING FOR CONSTRUCTION OF C. T./P.T.  
TOILET SEATS 4 Nos URINAL 5 Nos  
MODLE NO.- G

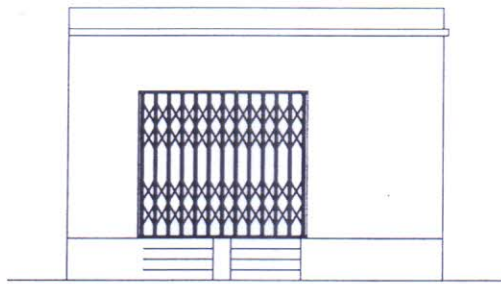

FRONT ELEVATION

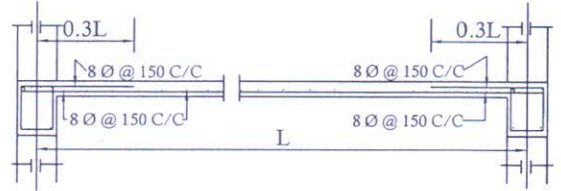
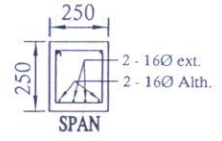
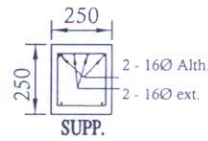
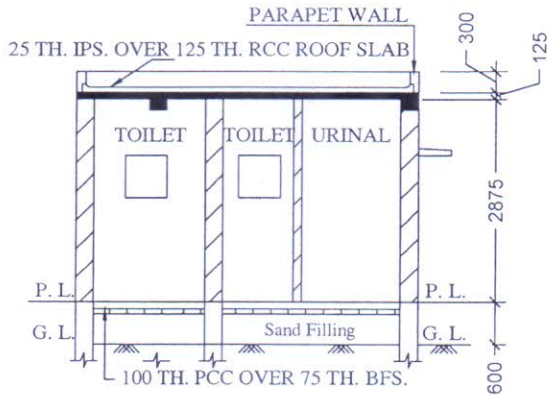

Details Of R.C.C Roof Slab & Beam

(SCALE - 1 : 25)

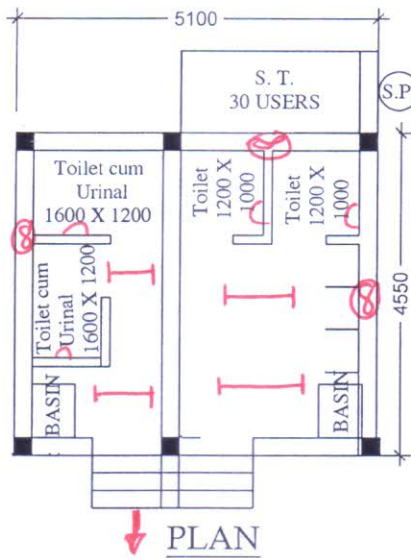

BHLP → 04

TL → 04

EF → 03

CF → 01

OL → 01

G.S.B → 01

14 pts

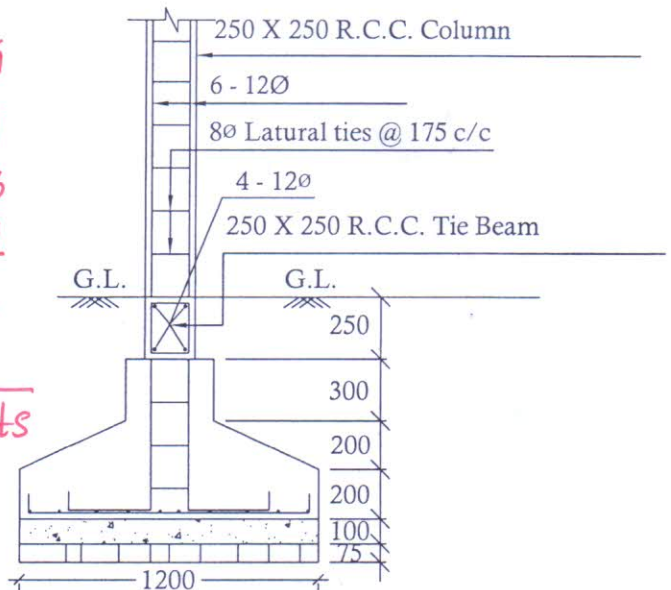

10Ø Bothways @ 125 c/c

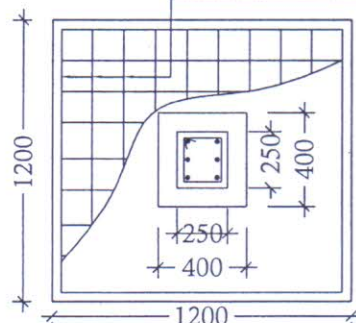

DETAILS OF R. C. C COLUMN

(SCALE - 1 : 25)

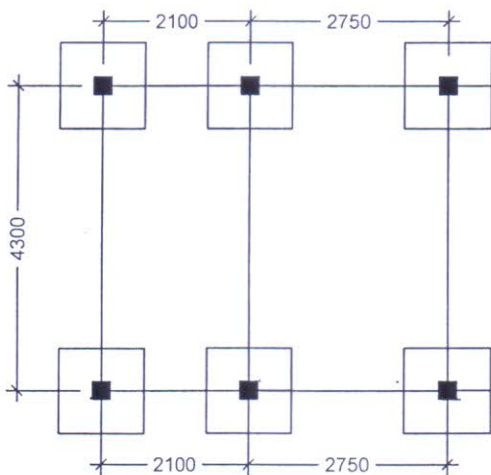

LAYOUT PLAN

Bankura Municipality

S.A.E.  
27/12/24

Chairperson  
Bankura Municipality  
27/12/24