

**NAME OF WORK:- ESTIMATE FOR ELECTRICAL WORK OF 7 SEATED PUBLIC TOILET
AT MIDNAPORE MEDICAL COLLAGE IN WARD NO.-12 WITHIN MIDNAPORE
MUNICIPALITY OF WEST BENGAL (MODEL NO - E)**

INSPIRATIONAL PARAMETERI

* As per PWD & I & WD schedule 3% & 2% district charges applicable on PWD & I & WD schedule items

* No district charges will be applicable on non-schedule items

SI No.	Item Description	Unit	Quantity	Rate	Amount
1	<p>Distribution wiring in 2 x 22/0.3 (1.5 sqmm) single core stranded 'FR' PVC insulated & unsheathed copper wire (Brand approved by EIC) in 20mm size PVC rigid conduit 'FR' (Precision make), with 1x22/0.3 (1.5 sqmm) single core stranded 'FR' PVC insulated & unsheathed copper wire for ECC, to light/fan/call bell points with Piano Key type switch fixed on MS CRC sheet metal (16 SWG) switch board cum JB on wall complete with 2 no. suitable size "Ph & N" copper bar incl. bakelite/Perspex (wall matching color) top cover 3 mm thick and incl. 175mmx100mmx65mm inspection box, making earthing attachment, painting the MS box and mending good the damages to original finish. [PWD Schedule Page No-E-14 Item No-2a]</p>	Point	21 25	630.36	13237.56 15759.00
	Average run 5 mtr				
2	<p>Distribution wiring in 1.1 KV grade 22/0.3 (1.5 sqmm) single core stranded 'FR' PVC insulated & unsheathed copper wire (Brand approved by EIC) in 20mm size PVC rigid conduit 'FR' (Precision make), with 1.1 KV grade 1 x 22/0.3 (1.5 sqmm) single core stranded 'FR' PVC insulated & unsheathed copper wire as ECC, to 5A 3 pin flush type plug socket & Piano Key type switch fixed on MS CRC sheet metal (16 SWG) switch board cum JB on wall incl. bakelite/Perspex (wall matching color) top cover 3 mm thick and incl. painting the MS box and mending good the damages to original finish On Board (only for pay counter) [PWD Schedule Page No-E-15; I-4a]</p>	Point	2	69.01	138.02

3	Supplying and fixing 240V 32A Double Pole AC Type 30mA RCCB.(Complete Set) (ISI marked) [Make- Legrand] (Cat No 4113/95) [Legrand Page No-92]	Nos	1	5942.00	5942.00
4	Distribution wiring in 1.1 KV single core stranded 'FR' PVC insulated & unsheathed copper wire (Brand approved by EIC) in 20mm size PVC rigid conduit 'FR' (Precision make) incl. necy. fittings as required 2 x 36/0.3 (2.5 sqmm) + 1 x 22/0.3 (1.5 sqmm) ECC [PWD Schedule Page No-E-14 Iteam No-1a(ii)]	mtr	20 25	122.57	2451.40 3064.25
5	Supplying and fixing double-door SPN MCB Distribution Board with IP-42/43 protection, concealed in wall after cutting the wall & mending good the damages to original finish incl. Inter connection with suitable size of copper wire and neutral link & provision for earthing attachment. a) For (2+6 way) (Make -Havells) [PWD Schedule Page No-D-9;Iteam No-13]	No	1	1105.19	1105.19
6	Supplying and fixing 240/415 V MCB of Breaking capacity 10kA & C characteristics on din rail of existing DBs and necessary connection 6-32A SP MCB (Make -Havells) [PWD Schedule Page No-D-6;Iteam No-7]	Nos	6	173.04	1038.24
7	Supplying and fixing 240/415 V MCB Isolator on din rail of existing DBs and necessary connection. 40A DP MCB Isolator (Make -Havells) [PWD Schedule Page No-D-5;Iteam No-6]	Nos	1	214.24	214.24
8	Supply of TMC501 conventional industrial batten (Philips make) LED Tube,model no- TMC501 P1xT-LED 22W P3241 (WB I & WD schedule P-113, I- 5:3 F.22)	Nos	5 7	460.02	2300.10 3220.14
9	Fixing only single/twin fluroscent light fitting complete with all accessories directly on wall/ceiling by screws etc.. [PWD Schedule Page No-C-2;Iteam No-14a]	Nos	5 7	88.58	442.90 620.06
10	Supply & fixing Bulk head light fittings with die cast aluminium housing frosted/clear glass on wall/ceiling incl S/F 9 watt LED Lamp complete set. [Make - Havells] (PWD sch - Page--D-13, I-23)	Nos	9	671.37	6042.33

11	Supply & fixing smart bright street light complete with all accessories to be fixed from the wall of building or on pole incl. making holes /providing clamping arrangement & necy. GI reducer as required.S&F 40 mm GI Pipe 1.5 mtr average length & s&f necy length of 1.5 sqmm pvc insulated single core copper wire & making connections as required & mending good damages incl wall paingting. (30 Watt) (Make - Bajaj) [WB I&WD sch P-111, I-f.9.0.2]	Nos	1 1	3076.32 3076.32	3076.32 3076.32
12	Supply of 12" domestic metal exhaust fan 12" 230V 50 Hz SWEEP. TRANS AIR - (Make-Crompton/Havells/Bajaj) (UD & MA schedule P-14, I-5))	Nos	4 6	2093.00	8372.00 12558.00
13	Fixing only exhaust fan after making hole in wall and making good damages and smooth cement finish etc. as practicable as possible and providing necy. length of PVC insulated wire and making connection for exhaust of following diameter: 30 cm (12") [PWD Schedule Page No-C-4;Iteam No-28(b)]	Nos	4 6	338.87 338.87	1355.48 2033.22
14	Fixing only louver shutter/cowl on wall with necy. bolts & nuts (6 mm dia x 62 mm long) For 30 cm(12") Exhaust fan [PWD Schedule Page No-C-4;Iteam No-30(b)]	Nos	4 6	113.30 113.30	453.20 679.80
15	S/F 240V 25A Modular type starter (brand approved by EIC)with 25 A. Modular switch DP MCB (C-Curve)and 4 Module G.I. Moduar type switch board with 4 Module Top Cover Plate flushed in wall incl. S/F switch board and Cover Plate and making necy. Connections with PVC Copper wire and earth connectivity wire etc. as per schedule [for Pump] [PWD Schedule Page No-E-19, Item No-17] (Please follow in details)	Nos	1 1	807.52 807.52	807.52 807.52
16	Supply of 240V A.C Ceiling Fan (48" sweep,1200 mm complete) [Make-Crompton [for counter only] (UD & MA schedule P- 23, I- 70)	Each	1 1	2283.00 2283.00	2283.00 2283.00
17	Fixing only Ceiling Fan [PWD sch P- C-3, I-21(a)]	Each	1 1	67.98 67.98	67.98 67.98

18	Supply & Fixing 240 V, 16/20 A Piano key type switch (Brand approved by EIC) on sheet metal switch board incl. S & F 100x100x65mm MS (16SWG) switch board and bakelite/perspex top cover of 3mm thick by Brass screws after making housing for switch by cutting bakelite/perspex cover and making necessary connections as required. (For Hand Dryer machine) [PWD sch P- E-6, I-17(b)]	Each	2	207.03	414.06
19	Supply and Fixing of 2 mm Polyvinyl glow sign board made of 22 SWG GI sheet box with 1"X1" aluminum channel for fixing the vinyl board after necessary cutting the letter as required & s/f LED tube light fittings along with all accessories. (16 sqft @495.00/sqft) (UD & MA schedule P-14, I-4)	Nos	1	7920.00	7920.00
20	Earthing installation by GI earth Spike (1830 X 20 mm) including 8SWG GI EarthWire & GI nuts, bolts, washer etc.	Nos	1	450.00	450.00
Total			67433.37		58111.54
Add 18% GST			12138.00		10460.08
Total With GST			79571.37		68571.62
Cess@1%			795.71		685.72
total			80367.08		69257.33
Contingency@3%			2387.14		2057.15
Total			82754.22		71314.48
Say Rs.					71314.00
(RUPEES SEVENTY ONE THOUSAND THREE HUNDRED FORTY EIGHT ONLY.)					
Service Connection Charges as per Quotation					

Say Rs. 82,754.00

Executive Officer
Midnapore Municipality



Chairman
Midnapore Municipality

Technically Vetted Rs.: 82,754.00

(Rupees Eighty two thousand Seven
Hundred fifty four only.)

60
07.07.25
Junior Engineer
Electrical & Mechanical Division
SUDA

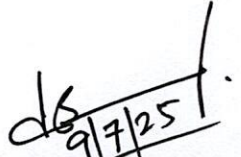

ASSISTANT ENGINEER
ELECTRICAL & MECHANICAL DIVISION
SUDA

Executive Engineer (E/M)
O/O the Secretary M.E. Dte.
Government of West Bengal

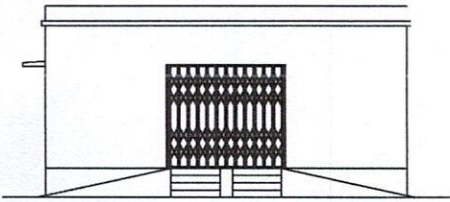
DRAWING FOR THE CONSTRUCTION OF P.T AT MIDNAPORE
 MEDICAL COLLEGE & HOSPITAL PREMISES IN WARD NO-12
 WITHIN MIDNAPORE MUNICIPALITY
 TOILET SEAT 7 NOS, URINAL 10 NOS
 MODLE NO.- E

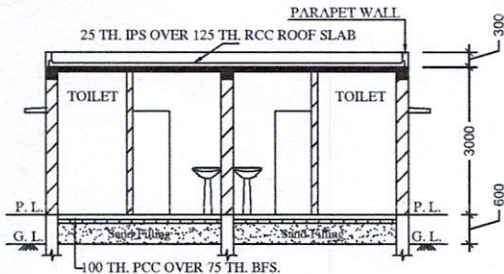

FRONT ELEVATION



SECTION - 'B - B'

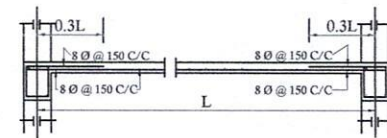
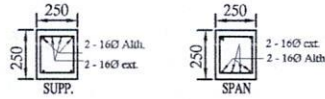

Details Of R.C.C Roof Slab & Beam
 (SCALE - 1:25)

BHLP → 09

TL → 07

EF → 06

OL → 01

CF → 01

G.S.B → 01

25 pts

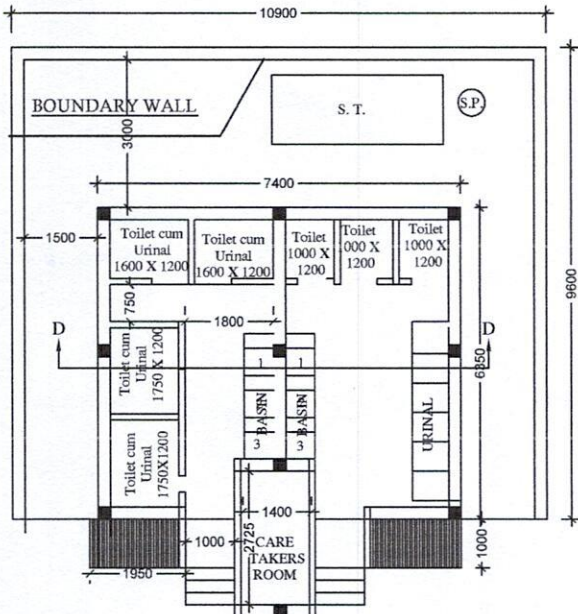

PLAN

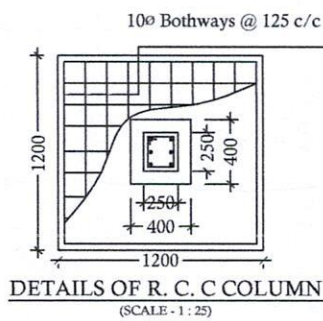
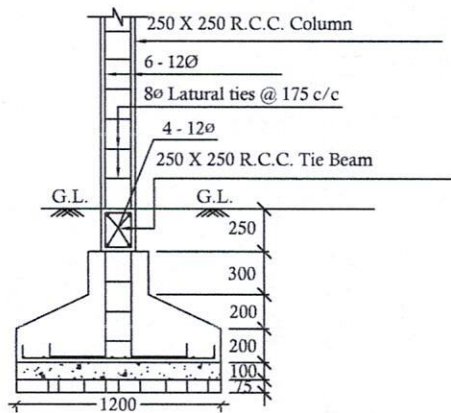

DETAILS OF R. C. C COLUMN
 (SCALE - 1:25)

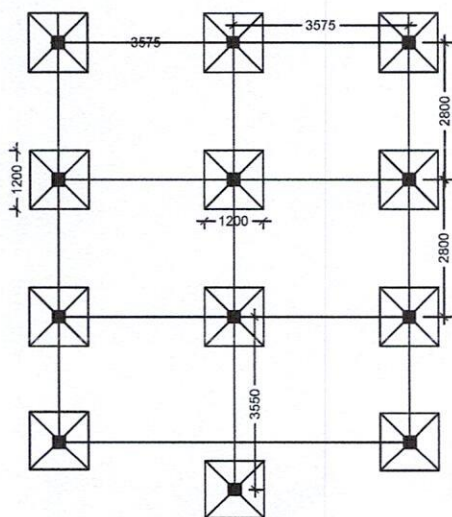

LAYOUT PLAN

[Signature]
 Executive Officer
 Midnapore Municipality

[Signature]
 Chairman
 Midnapore Municipality