

ESTIMATE FORM

ENGLISHBAZAR MUNICIPALITY, MALDA

Estimate of Civil Works for Construction of Institutional /Public Toilet Block at Malda Academy High School in Ward No. - 24 Under Englishbazar Municipality, Malda (W.B). (MODEL NO -F)

Sl. No	Description of Item						Quantity	Rate	Unit	Amount
	Count	No(s)	L	W/B	H/D	Total				
1	Earth work in excavation of foundation trenches or drains, in all sorts of soil (including mixed soil but excluding laterite or sandstone) including removing, spreading or stacking the spoils within a lead of 75 m. as directed. The item includes necessary trimming the sides of trenches, levelling, dressing and ramming the bottom, bailing out water as required complete. (a) Depth of excavation not exceeding 1,500 mm. PWD(WB), S.O.R. Volume- I : Building Works w.e.f. 01/11/2017, Item No.-2, Page No. - 1									
	Column Footing	4.000	1.000	1.200	1.200	1.125	6.480			
	Tie Beam	2.000	1.000	4.350	0.250	0.475	1.033			
		3.000	1.000	2.325	0.250	0.425	0.741			
	Part beam	1.000	1.000	1.725	0.250	0.425	0.183			
		1.000	1.000	1.200	0.250	0.425	0.128			
		1.000	1.000	1.000	0.250	0.425	0.106			
	Stair	1.000	1.000	2.250	0.750	0.075	0.127			
	water reservior	1.000	1.000	1.550	1.400	1.450	3.147			
							11.945	11.945	11927.00	%Cum
2	Earth work in filling in foundation trenches or plinth with good earth, in layers not exceeding 150 mm. including watering and ramming etc. layer by layer complete. (Payment to be made on the basis of measurement of finished quantity of work) (a) With earth obtained from excavation of foundation PWD(WB), S.O.R. Volume- I : Building Works w.e.f. 01/11/2017, Item No.-3, Page No. - 1									
	2/3 of It. No- 1		2/3	11.945			7.963	7.963	7754.00	%Cum
3	(A) Filling in foundation or plinth by silver sand in layers not exceeding 150 mm as directed and consolidating the same by thorough saturation with water, ramming complete including the cost of supply of sand. (payment to be made on measurement of finished quantity) PWD(WB), S.O.R. Volume- I : Building Works w.e.f. 01/11/2017, Item No.-4(A), Page No. - 2									
	Toilet, urinal	1.000	1.000	1.725	1.200	0.600	1.242			
		1.000	1.000	1.500	1.200	0.600	1.080			
		1.000	1.000	2.325	1.375	0.600	1.918			
		1.000	1.000	1.725	1.000	0.600	1.035			
		1.000	1.000	1.125	1.000	0.600	0.675			
							5.950	5.950	43131.00	%Cum
4	Single Brick Flat Soling of picked jhama bricks including ramming and dressing bed to proper level and filling joints with local sand. 3rdCORRIGENDA&ADDENDA,Dated:04.06.2018,Page1of 96, PWD(WB), S.O.R. Volume- I : BuildingWorksw.e.f. 01/11/2017, Item No.-1, Page No. - 14									
	Column	4.000	1.000	1.200	1.200		5.760			
	Tie Beam	2.000	1.000	4.350	0.250		2.175			
		2.000	1.000	2.325	0.250		1.163			
	Part Beam	1.000	1.000	1.725	0.250		0.431			
		1.000	1.000	1.200	0.250		0.300			
		1.000	1.000	1.000	0.250		0.250			

stair	1.000	1.000	2.250	0.750		1.688					
Floor	1.000	1.000	4.100	2.375		9.738					
water reservior	1.000	1.000	1.550	1.400		2.170					
						23.675	23.675	322.00	Sq.M.	7623.35	
5	Ordinary Cement concrete (mix 1:2:4) with graded stone chips (20 mm nominal size) excluding shuttering and reinforcement, if any, in ground floor as per relevant IS codes. Rate Analysis Enclosed										
Column	4.000	1.000	1.200	1.200	0.100	0.576					
Tie Beam	2.000	1.000	4.350	0.250	0.100	0.218					
	2.000	1.000	2.325	0.250	0.100	0.116					
Part Beam	1.000	1.000	1.725	0.250	0.075	0.032					
	1.000	1.000	1.200	0.250	0.075	0.023					
	1.000	1.000	1.000	0.250	0.075	0.019					
Stair	1.000	1.000	2.250	0.750	0.100	0.169					
	1.000	1.000	2.250	0.500	0.100	0.113					
	1.000	1.000	2.250	0.250	0.100	0.056					
Plinth Protection	1.000	1.000	17.350	0.500	0.100	0.868					
Floor	1.000	1.000	4.100	2.375	0.100	0.974					
water reservior	1.000	1.000	1.550	1.400	0.075	0.163					
						3.327	3.327	4521.93	Cu.M	15044.46	
6	Ordinary Cement concrete (mix 1:1.5:3) with graded stone chips (20 mm nominal size) excluding shuttering and reinforcement if any, in ground floor as per relevant IS codes. (i) Pakur Variety [PWD BUILDING WORKS, Page- 26, It. No- 10. i] Rate Analysis Enclosed										
Footing	4.000	1.000	1.200	1.200	0.200	1.152					
$(1.20 + 0.40) / 2 = 0.80$	4.000	1.000	0.800	0.800	0.200	0.512					
	4.000	1.000	0.400	0.400	0.300	0.192					
Tie Beam	3.000	1.000	2.325	0.250	0.250	0.436					
Part beam	1.000	1.000	1.200	0.250	0.250	0.075					
Tie Beam	2.000	1.000	4.350	0.250	0.300	0.653					
Part beam	1.000	1.000	1.725	0.250	0.250	0.108					
Part beam	1.000	1.000	1.000	0.250	0.250	0.063					
$Col[2.875+0.25+0.6]=3.725$	4.000	1.000	0.250	0.250	3.725	0.931					
Lintel	3.000	1.000	2.325	0.250	0.150	0.262					
	2.000	1.000	4.350	0.250	0.150	0.326					
Protection wall	1.000	1.000	1.725	0.125	0.150	0.032					
	1.000	1.000	1.200	0.125	0.150	0.023					
	1.000	1.000	1.000	0.125	0.150	0.019					
Chazza	3.000	1.000	0.500	0.450	0.100	0.068					
Roof beam	2.000	1.000	4.850	0.250	0.275	0.667					
	3.000	1.000	2.825	0.250	0.175	0.371					
Roof slab	1.000	1.000	5.150	3.125	0.125	2.012					
$1.85+0.15*2=5.15$	1.000	1.000	1.550	1.400	0.100	0.217					
water reservior Bed											
water reservior Slab	1.000	1.000	1.550	1.400	0.125	0.271					

						8.390	8.390	5052.35	Cu.M	42389.22
25 mm. thick damp proof with cement concrete (1:1.5:3) (with graded stone aggregate 10 mm. normal size) and painting the top surface with a coat of bitumen [VG.40] using 1.7 kg. per sq.m. including heating the bitumen and cost and carriage of all materials complete. [Bitumen to be supplied by the Agency]										
3rd CORRIGENDA & ADDENDA, Dated: 04.06.2018, Page 22 of 96, PWD(WB). S.O.R. Volume - I : Building Works w.e.f. 01/11/2017, Item No.-2, Page No. - 47 Rate Analysis Enclosed										
Tie Beam	2.000	1.000	4.350	0.250		2.175				
	3.000	1.000	2.325	0.250		1.744				
Part beam	1.000	1.000	1.725	0.125		0.216				
	1.000	1.000	1.200	0.125		0.150				
	1.000	1.000	1.000	0.125		0.125				
						4.410	4.410	245.01	Sq.M.	1080.49
8 125 mm. thick brick work with 1st class bricks in cement mortar (1:4) in ground floor. Rate Analysis Enclosed										
Partation wall	1.00	1.00	1.73			2.725	4.701			
						2.875-0.15 = 2.725				
	1.00	1.00	1.20			2.725	3.270			
	1.00	1.00	1.00			2.725	2.725			
Parapet wall	1.00	1.00	15.35			0.300	4.605			
						15.301	15.301	668.33	Sq.M.	10226.12
9 Supplying and laying Polythene Sheet (150gm / sq.m.) over damp proof course or below flooring or roof terracing or in foundation or in foundation trenches.or. PWD(WB), S.O.R. Volume- I : Building Works w.e.f. 01/11/2017, Item No.-3, Page No. - 47										
	1.000	1.000	17.350	0.500		8.675	8.675	24.00	Sq.M.	208.20
10 Hire and labour charges for shuttering with centering and necessary staging upto 4 m using approved stout props and thick hard wood planks of approved thickness with required bracing for concrete slabs, beams and columns, lintels curved or straight including fitting, fixing and striking out after completion of works (upto roof of ground floor) (When the height of a particular floor is more than 4 m the equivalent floor height shall be taken as 4 m and extra for works beyond the initial 4 m ht. shall be allowed under 12 (c) for every 4 m or part thereof) (f) 25 mm to 30 mm shuttering without staging in foundation PWD(WB), S.O.R. Volume- I : Building Works w.e.f. 01/11/2017, Item No.-36, Page No. - 42										
Footing	4.000	4.000	1.200		0.200	3.840				
Column pedestal	4.000	4.000	0.400		0.300	1.920				
Column	4.000	4.000	0.250		0.850	3.400				
Tie Beam	2.000	2.000	4.350		0.300	5.220				
	3.000	2.000	2.325		0.250	3.488				
Part beam	1.000	2.000	1.725		0.250	0.863				
	1.000	2.000	1.200		0.250	0.600				
	1.000	2.000	1.000		0.250	0.500				
water reservoir slab side	1.000	1.000	5.900		0.125	0.738				
						20.569	20.569	205.00	Sq.M.	4216.65

fire and labour charges for shuttering with centering and necessary staging upto 4 m using approved stout props and thick hard wood planks of approved thickness with required bracing for concrete slabs, beams and columns, lintels curved or straight including fitting, fixing and striking out after completion of works (upto roof of ground floor)

(When the height of a particular floor is more than 4 m the equivalent floor height shall be taken as 4 m and extra for works beyond the initial 4 m ht. shall be allowed under 12 (e) for every 4 m or part thereof)

(c) Steel shuttering or 9 to 12 mm thick approved quality ply board shuttering in any concrete work

PWD(WB). S.O.R. Volume- 1 : Building Works w.e.f. 01/11/2017, Item No.-36, Page No. - 42

Column	4.000	4.000	0.250		2.725	10.900
Lintel	2.000	2.000	4.850		0.150	2.910
	3.000	2.000	2.825		0.150	2.543
Partiaion wall	1.000	2.000	1.725		0.150	0.518
	1.000	2.000	1.200		0.150	0.360
	1.000	2.000	1.000		0.150	0.300
Opening, Door	2.000	1.000	1.050		0.250	0.525
	2.000	1.000	0.750		0.125	0.188
Window	3.000	1.000	0.450		0.250	0.338
Chazza	3.000	1.000	0.500		0.450	0.675
	3.000	1.000	1.400		0.100	0.420
Roof beam	4.000	1.000	2.225		0.250	2.225
	2.000	1.000	4.350		0.275	2.393
	2.000	1.000	1.725		0.125	0.431
	2.000	1.000	2.500		0.125	0.625
Outerside	1.000	1.000	15.350		0.275	4.221
Roof slab	1.000	1.000	4.850	2.825		13.701
water reservior slab bottom	1.000	1.000	1.050	0.900		0.945
						44.218

44.218 363.00 Sq.M. 16051.13

12 Artificial stone in floor, dado, staircase etc with cement concrete (1:2:4) with stone chips, laid in panels as directed with topping made with ordinary or white cement (as necessary) and marble dust in proportion (1:2) including smooth finishing and rounding off corners including raking out joints or roughening of concrete surface and application of cement slurry before flooring works using cement @ 1.75 kg/sq.m all complete including all materials and labour.
In ground floor.
3 mm. thick topping (High polishing grinding on this item is not permitted with ordinary cement).
Using grey cement
(ii) 25 mm. thick

Roof	1.00	1.00	5.15		3.13	16.094
------	------	------	------	--	------	--------

16.094 243.83 Sq.M 3924.2

13 Reinforcement for reinforced concrete work in all sorts of structures including distribution bars, stirrups, binders etc initial straightening and removal of loose rust (if necessary), cutting to requisite length, hooking and bending to correct shape, placing in proper position and binding with 16 gauge black annealed wire at every intersection, complete as per drawing and direction.

10th CORRIGENDA & ADDENDA, Dated: 22.01.2020, Page - 1 of 6, PWD(WB), S.O.R. Volume - 1 : Building Works w.e.f. 01/11/2017, Item No.-40, Page No. - 43

(a) For works in foundation and upto roof of ground floor/upto 4 m
(i) Tor steel/Mild Steel

III. OTHER MANUFACTURERS NOT SPECIFIED

1.20% of Item No(6)	0.012	8.390	7.850			0.790
---------------------	-------	-------	-------	--	--	-------

0.790 58229.74 MT 46001.49

collapsible gate with 40mm x 40mm x 6mm Tee as top and bottom guide rail, 20mm x 10mm x 2mm vertical channels 100mm apart in fully stretched position 20mm x 5mm M.S. flats as collapsible bracings properly rivetted and washered including 38mm steel rollers including locking arrangements, fitted and fixed in position with lugs set in cement concrete and including cutting necessary holes, chasing etc. in walls, floors etc. and making good damages complete. (Add extra @ 1% for each addl. floor upto 4th floor and @ 1.25% for each addl. floor above 4th floor) In ground floor. 3rd CORRIGENDA&ADDENDA, Dated:04.06.2018, Page92 of 96.PWD(WB), S.O.R. Volume- 1 :Building Works w.e.f. 01/11/2017, Item No.-18, Page No. - 106							4.305	4.305	4351.00	Sq.M	18731.06
15	Brick work with 1st class bricks in cement mortar (1:6) (b) In superstructure, ground floor Rate Analysis Enclosed $[3.0-(0.375+0.15) = 2.475]$										
	1.000	3.000	2.325	0.250	2.475	4.316					
	1.000	2.000	4.350	0.250	2.475	5.383					
	Deduction										
	Window										
	-3.000	1.000	0.450	0.250	0.600	-0.203					
	Door										
	-1.000	1.000	2.050	0.250	2.100	-1.076					
						8.420	8.420	5095.88	Cu.M	42907.31	
16	Brick work with 1st class bricks in cement mortar (1:6) (a) In foundation and plinth Rate Analysis Enclosed										
	1.000	2.000	4.350	0.250	0.600	1.305					
	above Tie Beam										
	1.000	3.000	2.850	0.250	0.600	1.283					
	water reservior										
	1.000	1.000	5.980	0.250	1.200	1.794					
						4.382	4.382	4872.88	Cu.M	21352.96	
17	Labour for Chipping of concrete surface before taking up Plastering work. [PWD BUILDING WORKS, Page- 192, It. No- 1]										
	4.000	4.000	0.250		3.350	13.400					
	Column										
	3.000	2.000	2.325		0.150	2.093					
	Lintel										
	2.000	2.000	4.350		0.150	2.610					
	Partition wall										
	1.000	2.000	1.600		0.150	0.480					
	Below opening										
	1.000	2.000	1.200		0.150	0.360					
	Window										
	3.000	1.000	0.450		0.250	0.338					
	Door										
	2.000	1.000	1.050		0.250	0.525					
	2.000	1.000	0.750		0.125	0.188					
	Chazza										
	3.000	1.000	1.400		0.100	0.420					
	Roof beam										
	4.000	1.000	4.850		0.275	5.335					
	6.000	1.000	2.825		0.175	2.966					
	In side										
	2.000	2.000	4.350		0.125	2.175					
	Inside										
	2.000	1.000	2.325		0.125	0.581					
	Roof										
	1.000	1.000	4.350		2.825	12.289					
						44.060	44.060	21.000	Sq.M	925.26	

	Plaster (to wall, floor, ceiling etc.) with sand and cement mortar including rounding off or chamfering corners as directed and raking out joints including throating, nosing and drip course, scaffolding/staging where necessary (Ground floor).[Excluding cost of chipping over concrete surface] (i) With 1:6 cement mortar (c) 15 mm thick plaster Rate Analysis Enclosed												
	Outside	1.000	2.000	4.850		3.900	37.830						
		1.000	2.000	2.825		3.900	22.035						
	Chazza	3.000	1.000	0.450	0.500		0.675						
		3.000	1.000	1.400		0.100	0.420						
	Inside	4.000	1.000	2.325		3.900	36.270						
		2.000	1.000	4.850		3.900	37.830						
	Partion wall	1.000	1.000	1.725		2.875	4.959						
		1.000	1.000	1.200		2.875	3.450						
		1.000	1.000	1.000		2.875	2.875						
	Parapet wall	1.000	2.000	4.730	0.125		1.183						
		1.000	2.000	2.700	0.125		0.675						
	Insde	1.000	2.000	4.350		0.300	2.610						
		1.000	2.000	4.325		0.300	2.595						
	Deduction	-2.000	2.000	1.050		2.100	-8.820						
		-2.000	2.000	0.750		2.100	-6.300						
		-3.000	2.000	0.450		0.600	-1.620						
	Water Reserrior	1.00	1.00	3.90		1.200	4.680						
							141.347	141.347	139.48	Sq.M		19715.08	
19	Plaster (to wall, floor, ceiling etc.) with sand and cement mortar including rounding off or chamfering corners as directed and raking out joints including throating, nosing and drip course, scaffolding/staging where necessary (Ground floor).[Excluding cost of chipping over concrete surface] (ii) With 1:4 cement mortar (c) 10 mm thick plaster Rate Analysis Enclosed												
	Chazza	3.00	1.00	0.45		0.500	0.675						
	Roof	1.00	1.00	4.35		2.325	10.114						
							10.789	10.789	124.48	Sq.M		1343.01	
20	Neat cement punning about 1.5mm thick in wall, dado, window sill, floor etc. NOTE:Cement 0.152 cu.m per100 sq.m. Rate Analysis Enclosed												
	G.L to P.L	1.00	1.00	15.35		0.60	9.210						
	Water Reserrior	1.00	1.00	3.90		1.20	4.680						
							13.890	13.890	32.72	Sq.M		454.48	
21	Supplying, fitting and fixing fibre reinforced polymer (FRP) Composite door frame as per approved section with glass fibre reinforced plastic moulded skins and a special sandwich core, so as to impart monolithic composite structure as per approved technology of Department of Science and Technology (DST) to satisfy IS: 4020 door testing performance criteria. (i) 66mm x 90mm [PWD BUILDING WORKS, Page- 115, It. No- 3.i]												
		1.00	2.00	4.95			9.900	9.900	497.00	Mtr.		4920.30	

	supplying, fitting & fixing fibre reinforced polymer (FRP) Composite door shutters as per approved design with glass fibre reinforced plastic moulded skins and a special sandwich core, so as to impart monolithic composite structure as per approved technology of Department of Science and Technology (DST) to satisfy IS:4020 door testing performance criteria. In ground floor. (ii) 32 mm thick [PWD BUILDING WORKS, Page- 125, It. No- 14.i]										
		1.00	2.00		0.75	2.10	3.150	3.150	2763.00	Sq.M	8703.45
23	Anodised aluminium barrel / tower / socket bolt (full covered) of approved manufactured from extruded section conforming to I.S. 204/74 fitted and fixed with cadmium plated screws: (vii) 225mm long x 10mm dia. bolt. [PWD BUILDING WORKS, Page- 144, It. No- 26.vii]							2.000	84.00	Each	168.00
24	Iron butt hinges of approved quality fitted and fixed with steel screws, with ISI mark. (viii) 100mm. X 75mm. X 3.50mm [PWD BUILDING WORKS, Page- 140, It. No- 5. viii]							6.000	66.00	Each	396.00
25	Anodised aluminium decorative handle (hexagonal / fluted) of approved quality fitted and fixed complete. (i) 150mm plate x 10mm dia rod x 12mm hexagonal/fluted. [PWD BUILDING WORKS, Page- 146, It. No- 31. i]							4.000	87.00	Each	348.00
26	Iron skeleton bolt of approved quality fitted and fixed complete. (b) 450mm long x 10mm dia rod. [PWD BUILDING WORKS, Page- 141, It. No- 10. b]							2.000	104.00	Each	208.00
27	Supplying & laying 20 mm designer chequered tiles of any shade and of approved quality as per IS: 1237: 1980 laid in patterns as directed in pavement, footpath including necessary underlay 25 mm thick average cement mortar (1:3) complete in all respect with all labour and materials [using cement slurry @ 4.4 kg/Sq.m at back side of tiles. Cement of mortar & slurry will be supplied by the Department. Border concrete if necessary to be paid separately]. 3rd CORRIGENDA & ADDENDA, Dated: 04.06.2018, Page 37 of 96, PWD(WB), S.O.R. Volume - I : Building Works w.e.f. 01/11/2017, Item No.-47, Page No. - 74										
		4.00	1.00	2.25		0.150	1.350				
		3.00	1.00	2.25		0.250	1.688				
		1.00	1.00	0.25		0.150	0.038				
		1.00	1.00	0.50		0.150	0.075				
		1.00	1.00	0.75		0.150	0.113				
							3.264	3.264	825.00	Sq.M	2692.80
28	Supplying and laying true to line and level Anti-Skid, Full Body, Homogeneous & Granular finish Vitrified Tiles conforming to IS:15622-2006 & IS 4457-2007 and testing shall be made in accordance with IS:13630 [Non- modular sizes for tiles with Skid resistance > 0.5, Mohr's hardness > 5.0, Staining resistance: Class-1, Water Absorption: E < 0.5%, MOR > 35 N/sq.mm in Internal area of building e.g. Toilet Block, Passage, Corridor, Accessible Open Terrace etc. set in 20 mm sand cement mortar (1:4) and 2 mm thick cement slurry at back side of tiles using cement @ 2.91 Kg./Sq.m or using Polymerised Adhesive (6 mm thick layer applied directly over finished artificial stone floor/ Mosaic etc without any backing course) laid after application slurry using 1.75 Kg. of cement per Sqm below mortar only, joints grouted with admixture of white cement and colouring pigment to match with colour of tiles/ epoxy grout materials of approved make as directed and removal of wax coating of top surface of tiles with warm water and polishing the tiles using soft and dry cloth upto mirror finish complete including the cost of materials, labour and all other incidental charges complete true to the manufacturer's specification and direction of Engineer-in-Charge. (White cement, synthetic adhesive and grout material to be supplied by the contractor). b) In Ground Floor: Sizes-600 mm x600mm x10 mm with breaking strength >1500 N 3rd CORRIGENDA & ADDENDA, Dated: 04.06.2018, Page 80 of 96, PWD(WB), S.O.R. Volume - I : Building Works w.e.f. 01/11/2017, Item No.-I, Page No. - 280										
		1.00	1.00	4.35	2.33		10.114	10.114	1589.00	Sq. M	16071.15

supplying, fitting & fixing best quality digital printed Ceramic tiles in coloured decorative on walls and floors to match with the existing work & 4 nos. key stones (10mm) fixed with adhesive 4.5mm thick at the back of each tile & finishing the joints with white cement mixed with colouring oxide if required to match the colour of tiles including roughening of concrete surface, if necessary or by synthetic adhesive & grout materials etc. With polymerised adhesive and epoxy grout pointing including spacer-2mm (When tiles are laid over existing hard ready surface) all complete as per direction of Engineer-in-charge. [PWD BUILDING WORKS, Page- 68, It. No- 39]												
Inside	4.00	1.00	2.33		2.10	19.530						
	2.00	1.00	4.35		2.10	18.270						
	1.00	1.00	1.60		2.10	3.360						
	1.00	1.00	1.20		2.10	2.520						
	1.00	1.00	1.00		2.10	2.100						
Deducting												
Window	-3.00	1.00	0.45		0.60	-0.810						
Door	-2.00	1.00	1.05		2.10	-4.410						
	-2.00	1.00	0.75		2.10	-3.150						
1/3 of opening	- 1/3	7.56				-2.520						
						34.890	34.890	1060.00	Sq. M	36983.40		
30	Supplying profiles of required section made of Aluminium Alloy Extrusions conforming to IS: 732-1983 and IS: 1285- 1975; Anodized (with required film thickness and specified colour / natural) matt finished conforming to IS: 1868-1983 for fabrication of composite door, sliding & casement windows, partitions, formed of basic sections of any ISI embossed / certified make and brand as per direction of Engineer - In- Charge. (Payment will be made on finished length of the work). A) In 10-12 Micron thickness Anodizing film l) Natural white h) Louvered window [PWD BUILDING WORKS, Page- 233, It. No- 1. A.I.h.											
	i) Top, bottom and side member.	3.00	1.00	2.10		6.300	6.300	183.00	Mtr.	1152.90		
	ii) Louvered Section.	3.00	1.00	0.60		1.800	1.800	658.00	Mtr.	1184.40		
	iii) Cleat angle (Non-anodized).	3.00	4.00	0.45		5.400	5.400	263.00	Mtr.	1420.20		
31	Labour charge for fabrication and installation of composite door, window, partitions made from anodized extruded alloy aluminium sections for the following units:- (A) Glazed aluminium sliding windows made of extruded and anodized alloy aluminium sections, fabrications, including cutting to proper shape and size, drilling and aligning of window shutter frame fitted with in built locking arrangements, sliding rollers and other necessary fittings, fixture, adhesives and joineries along with extruded neoprene or EPDM gasketing in between window frame and masonry work (walls, column, beam.lintels etc.) as well as between glass and shutter frame for fixing glass and Polysulphide sealant and in between shutter and window frame where necessary including cutting to requisite size and fixing glass as per drawing, specification and direction of EIC. The rate includes the hire charge of all tools and plants, including all incidental charges, adhesive, joineries such as screw, cleat angle etc. but excluding the cost of extruded aluminium sections, glass, neoprene / EPDM gasket, locking arrangement and rollers. v) Louvered window [PWD BUILDING WORKS, Page- 240, It. No- 2. A.v]											
		3.00	1.00	0.45		0.60	0.810	0.810	730.00	Sq. M	591.30	
32	Supplying bubble free float glass of approved make and brand conforming to IS: 2835-1987. iv) 5mm thick coloured / tinted / smoke glass. [PWD BUILDING WORKS, Page- 243, It. No- 9.iv]											
						0.810	0.810	585.00	Sq. M	473.85		
33	(a) M.S.or W.I. Ornamental grill of approved design joints continuously welded with M.S, W.I. Flats and bars of windows ,railing etc.fitted and fixed with necessary screws and lugs in ground floor. (i) Grill weighing above 10Kg./sq.mtr and up to 16Kg./sq. mtr. 3rd CORRIGENDA & ADDENDA, Dated: 04.06.2018, Page 91 of 96, PWD(WB), S.O.R. Volume- 1 : Building Works w.e.f. 01/11/2017, Item No.-13, Page No. - 104											

	ump house	5.00	1.00	0.60		0.60	1.800						
	Window	3.00	1.00	0.45		0.60	0.810						
						-	2.610						
				2.610	16.00	41.760	0.418	0.418	10021.00	Qntl		4188.78	
34	Rendering the Surface of walls and ceiling with White Cement base WATERPROOF wall putty of approved make & brand. (1.5 mm thick) PWD(WB), S.O.R. Volume- 1 : Building Works w.e.f. 01/11/2017, Item No.-5, Page No. - 198												
	same as- It. No- (17+18)- (19+29)		141.35	10.79	9.21	34.89	108.04	108.036	122.00	Sq. M		13180.39	
35	Acrylic Distemper to interior wall, ceiling with a coat of solvent based interior grade acrylic primer (as per manufacturer's specification) including cleaning and smoothing of surface. Two Coats PWD(WB), S.O.R. Volume- 1 : Building Works w.e.f. 01/11/2017, Item No.-10, Page No. - 196F												
	Inside	4.00	1.00	2.33		0.775	7.208						
	3.0-(.125+2.1)= 0.78	2.00	1.00	4.35		0.775	6.743						
		2.00	1.00	1.60		0.775	2.480						
		2.00	1.00	1.20		0.775	1.860						
		2.00	1.00	1.00		0.775	1.550						
	Slab	1.00	1.00	4.35		2.325	10.114						
							29.955	29.955	70.00	Sq.M		2096.85	
36	Applying Exterior grade Acrylic primer of approved quality and brand on plastered or concrete surface old or new surface to receive decorative textured (matt finish) or smooth finish acrylic exterior emulsion paint including scraping and preparing the surface thoroughly, complete as per manufacturer's specification and as per direction of the EIC. In Ground Floor: (b) Two Coats [PWD BUILDING WORKS, Page- 196, It. No- 8..b]												
	Outer side	1.00	2.00	4.85		3.600	34.920						
		1.00	2.00	2.83		3.600	20.340						
	Chazza	3.00	2.00	0.45		0.500	1.350						
		3.00	1.00	1.40		0.100	0.420						
	Parapet wall	1.00	2.00	4.85		0.125	1.213						
		1.00	2.00	2.83		0.125	0.706						
	In side	1.00	2.00	2.60		0.300	1.560						
		1.00	2.00	2.33		0.300	1.395						
	Deduction	-3.00	1.00	0.45		0.500	-0.675						
		-2.00	1.05	1.05		2.100	-4.631						
							56.598	56.598	4510.00	%Sq.M		2552.57	
37	Protective and Decorative Acrylic exterior emulsion paint of approved quality, as per manufacturer's specification and as per direction of Engineer-in-Charge to be applied over acrylic primer as required. The rate includes cost of material, labour, scaffolding and all incidental charges but excluding the cost of primer. In Ground floor (Two Coat) a) Normal Acrylic Emulsion [PWD BUILDING WORKS, Page- 197, It. No- 17.c]												
								56.598	67.00	Sq.M		3792.07	
38	(a) Priming one coat on steel or other metal surface with synthetic oil bound primer of approved quality including smoothing surfaces by sand papering etc. [PWD BUILDING WORKS, Page- 200, It. No- 1. a]												
	Pump house	5.00	1.00	0.60		0.60	1.800						
	Window	3.00	1.00	4.50		0.60	8.100						
	Collapsible	1.50	1.00	2.05		2.10	6.458						

					16.358	16.358	29.00	Sq. M	474.38
	(A) Painting with best quality synthetic enamel paint of approved make and brand including smoothening surface by sand papering etc. including using of approved putty etc. on the surface, if necessary : (b) On steel or other metal surface : With super gloss (hi-gloss) - (iv) Two coats (with any shade except white) [PWD BUILDING WORKS, Page- 201, It. No- 2. b.iv]				16.358	16.358	79.00	Sq. M	1292.28
40	Supplying, fitting and fixing Stainless Steel railing consistof 38 mmdia and 900 mm height vertical balustrade at every twoalternativesteps, 50mm dia top rail, 3 (three) nos 19mm dia horizontalStainless steel pipe andbase/cover plate with Strainless Steel GRADE 304 containing 7.5% nickle (Interior Grade) Brushed/Mat finish,completeasper direction of the Engineer-in-charge. Weight of Strainless Steel railing per metre 6.5 Kg (approx) 3rdCORRIGENDA&ADDENDA, Dated:04.06.2018, Page95 of96, PWD(WB), S.O.R. Volume- I .BuildingWorksw.e.f. 01/11/2017, Item No.-22, Page No. - 10				1.950	1.950	9077.00	Mtr	17700.12
41	Painting block letters or digits in Black Japan or any approved paint as per direction. e) Size above 7.5 cm. and upto 10 cm. [PWD BUILDING WORKS, Page- 268, It. No- 17. e]				450.000	450.000	12.00	Each	5400.00
42	Supplying and Planting of different plant / trees (Supplying well grown plants bushy and healthy, minimum height as specified i.e. exposed height including all leads & lift, carriage, handling, manuring, applying presticide and fertilizer etc. i) Furcaria variegated 10-12 leaves in height 20-30cm in earthen pots of size 25cm. [PWD BUILDING WORKS, Page- 261, It. No- 9. i]				7.000	7.000	162.00	Each	1134.00
43	x) Ficus blakii (F. Vivicon) well branched (Bushy) of height 120cm - 135 cm in earthen pot of size 30cm. [PWD BUILDING WORKS, Page- 261, It. No- 9. x]				3.000	3.000	187.00	Each	561.00
44	xxvi) Areca Palm 4 - 5 suckers of height 90 cm to 105 cm in earthen pots of size 25 cm. [PWD BUILDING WORKS, Page- 262, It. No- 9. xxvi]				3.000	3.000	127.00	Each	381.00

SANITARY AND PLUMBING WORKS

45	Supplying, fitting and fixing Anglo-Indian W.C. in white glazed vitreous china ware of approved make complete in position with necessary bolts, nuts etc. (a) With 'P' trap (with vent) [SANITARY AND DRAINAGE WORKS, Page- 79, It. No- 3. a]				2.000	2.000	3104.00	Each	6208.00
46	Supplying, fitting and fixing Closet seat of approved make with lid and C.P. hinges, rubber buffer and brass screws complete. (b) Anglo Indian (i) Plastic (hallow type) black [SANITARY AND DRAINAGE WORKS, Page- 81, It. No- 10. b.i]				2.000	2.000	371.00	Each	742.00
47	Supplying, fitting and fixing Flat back urinal (half stall urinal) in white vitreous chinaware of approved make in position with brass screws on 75 mm X 75 mm X 75 mm wooden blocks complete. (i) 635 mm X 395 mm X 420 mm [SANITARY AND DRAINAGE WORKS, Page- 80, It. No- 6. i]				2.000	2.000	2869.00	Each	5738.00
48	Supplying, fitting and fixing Squating plate with integral flushing in white vitreous chinaware of approved make in cement concrete (6:3:1) with jhama chips complete. (Payment of concrete will be paid seperately). (i) 450 mm X 350 mm [SANITARY AND DRAINAGE WORKS, Page- 80, It. No- 7. i]				1.000	1.000	881.00	Each	881.00
49	Supplying, fitting and fixing 10 litre porcelain low-down cistern of approvedmakewitheither sideor bottominlet, sideoverflow, brackets complete with all internal PVC fittings. White [SANITARY AND DRAINAGE WORKS, Page- 36, It. No- 1]				2.000	2.000	2297.00	Each	4594.00
50	Supplying, fitting and fixing 32 mm dia. Flush Pipe of approved make with necessary fixing materials and clamps complete. i) Polythene Flush Pipe [SANITARY AND DRAINAGE WORKS, Page- 81, It. No-11.i]				2.000	2.000	155.00	Each	310.00
51	Supplying, fitting and fixing urinal flush pipe fittings of approved brand (a) C.P. urinal flush pipe fittings range of one [SANITARY AND DRAINAGE WORKS, Page- 81, It. No-12.a]				3.000	3.000	414.00	Each	1242.00

	supplying, fitting and fixing white vitreous china best quality approved make wash basin with C.I. brackets on 75 mm X 75 mm wooden blocks, C.P. waste fittings of 32 mm dia., one approved quality brass C.P. pillar cock of 15 mm dia., C.P. chain with rubber plug of 30 mm dia., approved quality P.V.C. waste pipe with C.P. nut 32 mm dia., 900 mm long approved quality P.V.C. connection pipe with heavy brass C.P. nut including mending good all damages and painting the brackets with two coats of approved paint. (ii) 550 mm X 400 mm size [SANITARY AND DRAINAGE WORKS, Page- 41, It. No-2.ii]	2.000	2208.00	Each	4416.00
53	Supplying, fitting and fixing pedestal of approved make for wash basin (white) [SANITARY AND DRAINAGE WORKS, Page- 41, It. No-3]	2.000	1497.00	Each	2994.00
54	Supplying, fitting and fixing approved brand P.V.C. CONNECTOR white flexible, with both ends coupling with heavy brass C.P. nut, 15 mm dia. (iii) 600 mm long [SANITARY AND DRAINAGE WORKS, Page- 43, It. No- 9.iii]	5.000	107.00	Each	535.00
55	Supplying, fitting and fixing approved brand 32 mm dia. P.V.C. waste pipe, with PVC coupling at one end fitted with necessary clamps. (iv) 1050 mm long [SANITARY AND DRAINAGE WORKS, Page- 43, It. No- 10.iv]	4.000	91.00	Each	364.00
56	Supplying, fitting and fixing shower of approved brand and make. (i) Hand Shower (Health Faucet) with Imtr Flexible Tube with Wall Hook (Equivalent to Code No. 573 & Model -ALLIED of Jaquar or similar). [SANITARY AND DRAINAGE WORKS, Page- 3, It. No- 3.f]	2.000	1251.00	Each	2502.00
57	(ii) Chromium plated Bib Cock long body with wall flange with aerator (Equivalent to Code No. 512 & Model- Tropical / Sumthing Special of ESSCO or similar brand) [SANITARY AND DRAINAGE WORKS, Page- 6, It. No- 7. a.ii]	3.000	659.00	Each	1977.00
58	(b) (i) Chromium plated Stop Cock (Equivalent to Code No. 513(A) & 513(B) & Model - Tropical / Sumthing Special of ESSCO or similar [SANITARY AND DRAINAGE WORKS, Page- 6, It. No- 7. b.i]	1.000	493.00	Each	493.00
59	(d) (i) Chromium plated angular Stop Cock with wall flange (Equivalent to Code No. 5053 & Model - Florentine of Jaquar or similar brand). [SANITARY AND DRAINAGE WORKS, Page- 6, It. No- 7. d.i]	5.000	815.00	Each	4075.00
60	Supplying, fitting and fixing pillar cock of approved make. a) (i) CP Pillar Cock - 15 mm. (Equivalent to Code No. 507 & Model - Tropical / Sumthing Special of ESSCO or similar brand).	2.000	555.00	Each	1110.00
61	Supplying, fitting and fixing G.I. pipes of TATA make with all necessary accessories, specials viz. socket, bend, tee, union, cross, elbo, nipple, long screw, reducing socket, reducing tee, short piece etc. fitted with holder bats clamps, including cutting pipes, making threads, fitting, fixing etc. complete in all respect including cost of all necessary fittings as required, jointing materials and two coats of painting with approved paint in any position above ground. (Payment will be made on the centre line measurements of total pipe line including all specials. No separate payment will be made for accessories, specials. Payment for painting will be made separately) (a) For Exposed Work, (ii) 32 mm dia. medium quality [SANITARY AND DRAINAGE WORKS, Page- 02, It. No- 01. A) d.ii]	15.000	355.00	Mtr.	5325.00
62	Supplying, fitting and fixing PVC pipes of approved make of Schedule 80 (medium duty) conforming to ASTM D-1785 and threaded to match with GI Pipes as per IS : 1239 (Part-I). with all necessary accessories, specials viz. socket, bend, tee, union, cross, elbo, nipple, long screw, reducing socket, reducing tee, short piece etc. fitted with holder bats clamps, including cutting pipes, making threads, fitting, fixing etc. complete in all respect including cost of all necessary fittings as required, jointing materials and two coats of painting with approved paint in any position above ground. (Payment will be made on the centre line measurements of total pipe line including all specials. No separate payment will be made for accessories, specials. Payment for painting will be made separately) a) For Exposed Work PVC Pipes (Dia) 25 mm Dia [SANITARY AND DRAINAGE WORKS, Page- 12, It. No- 19. Ia]	10.000	177.00	Mtr.	1770.00
63	Supplying, fitting and fixing gunmetal wheel valve of approved brand and make tested to 21 kg per sq. cm. (for water lines only). (vii) 25 mm dia [SANITARY AND DRAINAGE WORKS, Page- 5, It. No- 5. vii]	2.000	778.00	Each	1556.00

	supplying P.V.C. water storage tank of approved quality with closed top with lid (Black) - Multilayer (b) 1000 litre capacity [SANITARY AND DRAINAGE WORKS, Page- 37, It. No- 6. b]	1.000	5128.00	Each	5128.00
65	Labour for hoisting plastic water storage tank. (i) Upto 1500 litre capacity. [SANITARY AND DRAINAGE WORKS, Page- 37, It. No- 10. i]	1.000	96.00	Each	96.00
66	Labour for punching hole in plastic water storage tank upto 50 mm dia. [SANITARY AND DRAINAGE WORKS, Page- 38, It. No- 13]	2.000	19.00	Each	38.00
67	Supply of UPVC pipes (B Type) & fittings conforming to IS-13592- 1992.(A) (i) Single Socketed 3 Meter Length, (b) 110 mm PWD S&P Schedule, Page No.-68 Item No. 23,(A)(i)(b)	30.000	292.00	Mtr	8760.00
	(B) Fittings (i) Coupler, (b) 110 mm	8.000	85.00	Each	680.00
	(ii) Plain Tee, (b) 110 mm	12.000	85.00	Each	1020.00
	(iii) Door Tee, (b) 110 mm	10.000	195.00	Each	1950.00
	ix) Bend 45°, (b) 110 mm	10.000	89.00	Each	890.00
	xi) Door Bend (T.S.), (b) 110 mm	7.000	147.00	Each	1029.00
	xxi) Pipe Clip, (b) 110 mm	30.000	21.00	Each	630.00
	xxii) W.C. Connector (150 mm long) 125 X 110(W/WC Ring) 75 mm	4.000	142.00	Each	568.00
	xxxii) Plain Floor Trap with Top tile & Strainer 75 mm	7.000	144.00	Each	1008.00
	L) Rubber Ring, (b) 110 mm	15.000	17.00	Each	255.00
	C)Rubber Lubricant 500 ML	1.000	187.00	500 ML	187.00
	D)Solvent Cement 250 ML	1.000	103.00	250 ML	103.00
68	Labour for fitting and fixing U.P.V.C. pipes for above ground work including cost of jointing materials etc. fitting and fixing all necessary specials, cutting pipes, cutting holes in total pipeline including specials. (B) Under ground, (ii) 110 mm dia. PWD S&P Schedule. (P. - 74, Item. No. - 24 (B))	20.000	84.00	Mtr	1680.00
69	Supplying, fitting & fixing UPVC pipes A- Type and fittings conforming to IS:13592-1992 with all necessary clamps nails, including making holes in walls, floor etc. cutting trenches in any soil through masonry concrete structures etc if necessary and mending good damages including joining with jointing materials (Spun Yarn, Valamoid/Bitumen/M-Seal etc) complete. A) UPVC Pipes: (i) 75 mm. Dia. (P. - 212. Item. No. - 21 (A)(i) , (B),(c),(i) & (B), (d),(i), Pwd volume- i, 2017)	20.000	188.00	Mtr	3760.00
70	B) UPVC Fittings: c) Bend 87.5 degree (i) 75 mm. Dia.	6.000	95.00	Mtr	570.00
71	B) UPVC Fittings: d) Shoe (i) 75 mm. Dia.	2.000	78.00	Mtr	156.00
72	Constructing Inspection pit of inside measurement 600mm X 600mm X upto 600mm (depth) with 250 mm thick 1st class brick work in cement mortar (1:4) on all sides, bottom of the pit consisting of 100 mm thick cement concrete (1:3:6) with stone chips over a layer of jhama brick flat soling, 15 mm thick (1:4) cement plaster to inside walls and out-side walls upto G.L. and 20 mm.thick (1:4) plaster to bottom of the pit, providing necessary invert with cement concrete (1:3:6) with stone chips as per direction, neat cement finishing to entire internal surfaces, top of the pit covered with 100 mm thick R.C.C. slab (1:1.5:3) with stone chips and necessary reinforcements upto 1% and shuttering including 6 mm thick cement plaster (1:4) in all external surfaces of the slab and one 500 mm dia. R.C.C. manhole cover of approved make supplied, fitted and fixed in the slab with necessary fittings, necessary earthwork in excavation in all sorts of soil, filling sides of the pit with earth and removing spoils after work complete in all respect with all costs of labour and materials. i) With Pakur variety.(OTHER MANUFACTURES NOT SPECIFIED) 7th CORRIGENDA & ADDENDA, Dated: 22.01.2020, Page 1 of 7, PWD(WB), S.O.R. Volume - II Sanitary & Plumbing Works w.e.f. 01/11/2017, Item No. - 1, Page No.- 87	2.000	6648.00	Each	13296.00
73	Supplying, fitting and fixing 18 mm thick marble partition slab with chawk doongri marble square cut, both sides polished with two front corners rounded and edges polished. PWD(WB), S.O.R. Volume - II : Sanitary & Plumbing Works w.e.f. 01/11/2017, Item No. - 13, Page No.- 81	0.930	1426.00	Sq.m	1326.18

<p>Construction of septic tank of different capacities as per approved drawing with 1st class brick work in cement mortar (1:4) including two 560 mm dia. R.C.C. manhole cover (heavy type) of approved make supplied, fitted and fixed in the 100mm thick R.C.C (1:1.5:3) top slab with necessary fittings, 20mm thick cement plaster (4 : 1) with neat cement finish to the internal surfaces and 15 mm thick cement plaster (4 : 1) to outside wall upto 200 mm below G.L floor finished with 25 mm thick grey artificial stone over 100 mm thick R.C.C(1:1.5:3) bottom slab including supplying, fitting and fixing all necessary specials, fittings, S.W. tees, C.I. foot rest etc. including excavation earth in all sorts of soil, shoring, bailing out and pumping out water as necessary, ramming, dressing the bed and refilling the sides of the tanks with earth, removing spoils, filling up the chamber with clear water, removing foreign materials from the chamber and including constructing attached inspection pit as per approved drawing and connecting all necessary pipes, joints etc. with internal plaster work and artificial stone flooring is to be done with admixture of water proofing compound @ 0.5% by weight of cement with all costs of labour and materials.</p> <p>Note - (i) Finished level of Septic Tank should be 400 mm. from Ground Level. (ii) Height of 50 mm Ventilation pipe & Mosquito proof mesh, should be followed as per IS 2470, Part- I. Payment will be made separately on the basis of actual height based on relevant I.S Code</p> <p>7th CORRIGENDA & ADDENDA, Dated: 22.01.2020, Page 3 of 7, PWD(WB), S.O.R. Volume - II Sanitary & Plumbing Works w.e.f. 01/11/2017, Item No. - 3, Page No.- 88 (i) For 20 users (ii) With Pakur variety (OTHER MANUFACTURES NOT SPECIFIED)</p>	1.000	45343.00	Each	45343.00
<p>75 Construction of circular soak well 2.5 metre deep in all types of sandy soils with dry brick work upto 1.0 metre from the bottom having 150 mm intermediate cement brick work (1:4) band all round and cement brick work (1:4) upto 0.90 metre from top with 20mm thick cement plastering (1:4) to inside face upto the depth of cement brick work, 15mm thick cement plaster (1:4) on outer face from top of the well upto G.L. and 6 mm thick cement plaster (1:4) on top of the R.C.C. cover slab including filling bottom 1.00 metre of inside of the well with brick metal (50 mm to 63 mm size) including R.C.C. cover slab of 100 mm thick with cement conc (1:1.5:3) with stone chips with necessary reinforcement and shuttering including one 560 mm dia. R.C.C. manhole cover (heavy type) of approved make supplied, fitted and fixed in the cover slab with necessary fittings, making necessary arrangements for pipe connections, excavation of well including shoring, dewatering and removing the excess earth from the premises as per direction complete in all respect with all costs of labour and materials. With 250 mm thick dry brick work and 250 mm thick cement brick work (1:6) and 1.00m inside dia</p> <p>For-OTHER MANUFACTURES NOT SPECIFIED) S.P.89 Item No. 4 7th Corrigenda Volume ii</p>	1.000	15451.00	Each	15451.00
<p>76 Supplying, fitting and fixing towel rail with two brackets. (a) C.P. over brass (ii) 25 mm dia. and 600 mm long PWD S&P Schedule, p No 82 I No- 22 (a)(ii)</p>	2.000	430.00	Each	860.00
<p>77 Supplying, fitting and fixing bevelled edged mirror 5.5 mm thick silver red as per I.S. 3438 / 1965 together with brass C.P. hinges. (ii) 600 mm X 450 mm PWD S&P Schedule, P-81, It-15(ii)</p>	2.000	484.00	Each	968.00
<p>78 Supplying, fitting and fixing soap holder. (b) Fibre glass Sanitary and plumbing work schedule P-82, It-18(b)</p>	2.000	58.00	Each	116.00
<p>79 Supplying, fitting and fixing glass shelf with aluminium guard rails. (a) Ordinary type with 5.5 mm sheet glass (i) 450 mm X 125 mm Sanitary and plumbing work schedule P-81, It-16(a)(i)</p>	2.000	341.00	Each	682.00
Total Amount excluding GST				538252.29
Add CGST @ 9%				48442.71
Add SGST @ 9%				48442.71
Total amount including GST				635137.71
Add Labour Welfare Cess. @ 1%				6351.38
Total Amount Including L.abour Welfare Cess.				641489.09
Add Contengency @3%				19054.13
Total Amount Including L.W.C. and contengency				660543.22
Say Rupees				660543.00

[Signature]
Junior Engineer
Malda Division
M. E. Directorate
Govt. of West Bengal

[Signature]
Assistant Engineer
Malda Division
M. E. Directorate
Govt. of West Bengal

[Signature]
S. A. E. (C)
English Bazar Municipality
MALDA

[Signature]
Vetted
Executive Engineer
Malda Division
M. E. Directorate
Govt. of West Bengal

[Signature]
Chairman
English Bazar Municipality
MALDA

ENGLISHBAZAR MUNICIPALITY, MALDA

Estimate of Non Schedule Items for Construction of Institutional /Public Toilet Block at Malda Academy High School in Ward No. - 24 Under Englishbazar Municipality, Malda of West Bengal (MODEL NO -F)

SL NO.	Description of Items	Unit	Quantity	Rate (Rs.)	Amount (Rs.)	
1	Standard plastic Dustbin(12lits)	Each	4	350.00	1400.00	
2	Air Freshner (Pack of 4 nos)	Each	5	216.00	1080.00	
3	Air Freshner (Naphthaline 250gm)	Each	5	210.00	1050.00	
4	Supplying paper napkin	Each	5	50.00	250.00	
5	Supplying Sanitary Napking (Whisper or similar make 50 pcs)	Each	4	520.00	2080.00	
6	Harpic (Blue 500ml)	Each	4	300.00	1200.00	
7	Harpic (Red 500ml)	Each	4	150.00	600.00	
8	Gala double lip floor wiper	Each	4	350.00	1400.00	
9	Colin glass or surface cleaner	Lit	2	200.00	400.00	
10	Muriatic acid	Lit	2	145.00	290.00	
11	Bleaching powder	kg	4	120.00	480.00	
12	Dettol, Lifeboy or similar make liquid soap	Lit	6	140.00	840.00	
13	Rubber hand gloves	pair	4	80.00	320.00	
14	Double Side plastic brush	Each	4	125.00	500.00	
15	Plastic Broom	Each	4	170.00	680.00	
16	Glow sign board Name and contact details of the following are displayed prominently – Toilet identification number , name of ULB under whose jurisdiction toilet is covered , ward number and maintainance authority prominently displayed for each toilet block supervisor , Supervisor agency and area Sanitary Inspector (D3)	Each	1	5000.00	5000.00	
17	Supplying and fixing sinage with fixing stand post for public toilet for visible to passersby.	Each	3	1000.00	3000.00	
18	Supplying roaster / register for keeping account of regular cleaning	Each	2	200.00	400.00	
19	Lettering on toilet wall for display of name and contact details of ULB, Ward number and name of maintainance authority, sanitary inspector, etc. (D3)	Each	1	1000.00	1000.00	
20	SMS/any other ICT based feedback system (with number displayed on which SMS has to be sent) (A9)	Each	1	5000.00	5000.00	
21	Mini tulu pump	Each	1	4000.00	4000.00	
22	Sinage ACP Base & reflective Vinyl	Each	2	3776.00	7552.00	
23	Installation of Sinage	Each	2	2071.00	4142.00	
				Total	Rs.	42664.00
				Add 1% Cess (Rs.)		426.64
				Total (Rs.)		43090.64
				Add 3% Contingency (Rs.)		1292.7192
				Grand Total (Rs.)		44383.36

3/4/25
Junior Engineer
Malda Division
M. E. Deptt. & MA
Govt. of West Bengal

3/4/25
Assistant Engineer
Malda Division
M. E. Deptt. & MA
Govt. of West Bengal

Pranab R. Das
S. A. E. (C)
English Bazar Municipality
MALDA

79370.56
Chairman
English Bazar Municipality
MALDA

3/4/25
Executive Engineer
Malda Division
M. E. Deptt. & MA
Govt. of West Bengal

ESTIMATE FORM

Name of Work:- Estimate for Electrical Work of 2 Seated Institutional Toilet Block at Malda Academy High School in Ward No. - 24 Under Englishbazar Municipality, Malda of West Bengal (MODEL NO -F)

* As per PWD & I & WD schedule district charges will be applicable on PWD & I & WD schedule items

* No district charges will be applicable on non-schedule items

Sl No.	Item Description	Unit	Quantity	Rate	Amount
1	Distribution wiring in 2 x 22/0.3 (1.5 sqmm) single core stranded 'FR' PVC insulated & unsheathed copper wire (Brand approved by EIC) in 20mm size PVC rigid conduit 'FR' (Precision make), with 1x22/0.3 (1.5 sqmm) single core stranded 'FR' PVC insulated & unsheathed copper wire for ECC, to light/fan/call bell points with Piano Key type switch fixed on MS CRC sheet metal (16 SWG) switch board cum JB on wall complete with 2 no. suitable size "Ph & N" copper bar incl. bakelite/ Perspex (wall matching color) top cover 3 mm thick and incl. 175mm x 100mm x 65mm inspection box, making earthing attachment, painting the MS box and mending good the damages to original finish. [PWD Schedule Page No-E-14 Item No-2a]	Point	12	642.60	7711.20
	Average run 5 mtr				
2	Distribution wiring in 1.1 KV grade 22/0.3 (1.5 sqmm) single core stranded 'FR' PVC insulated & unsheathed copper wire (Brand approved by EIC) in 20mm size PVC rigid conduit 'FR' (Precision make), with 1.1 KV grade 1 x 22/0.3 (1.5 sqmm) single core stranded 'FR' PVC insulated & unsheathed copper wire as ECC, to 5A 3 pin flush type plug socket & Piano Key type switch fixed on MS CRC sheet metal (16 SWG) switch board cum JB on wall incl. bakelite/Perspex (wall matching color) top cover 3 mm thick and incl. painting the MS box and mending good the damages to original finish On Board (only for pay counter) [PWD Schedule Page No-E-15; 1-4a]	Point	1	70.35	70.35
3	Supplying and fixing 240V 32A Double Pole AC Type 30mA RCCB.(Complete Set) (ISI marked) [Make- Legrand] (Cat No 4113/95) [Legrand Page No-92]	Nos	1	5942.00	5942.00
4	Distribution wiring in 1.1 KV single core stranded 'FR' PVC insulated & unsheathed copper wire (Brand approved by EIC) in 20mm size PVC rigid conduit 'FR' (Precision make) incl. necy. fittings as required 2 x 36/0.3 (2.5 sqmm) + 1 x 22/0.3 (1.5 sqmm) ECC [PWD Schedule Page No-E-14 Item No-1a(ii)]	mtr	10	124.95	1249.50
5	Supplying and fixing double-door SPN MCB Distribution Board with IP-42/43 protection, concealed in wall after cutting the wall & mending good the damages to original finish incl. Inter connection with suitable size of copper wire and neutral link & provision for earthing attachment. a) For (2+4 way) (Make -Havells) [PWD Schedule Page No-D-9;Item No-13]	No	1	981.75	981.75
6	Supplying and fixing 240/415 V MCB of Breaking capacity 10kA & C characteristics on din rail of existing DBs and necessary connection 6-32A SP MCB (Make -Havells) [PWD Schedule Page No-D-6;Item No-7]	Nos	4	176.40	705.60
7	Supplying and fixing 240/415 V MCB Isolator on din rail of existing DBs and necessary connection. 40A DP MCB Isolator (Make -Havells) [PWD Schedule Page No-D-5;Item No-6]	Nos	1	218.40	218.40
8	Supply of TMC501 conventional industrial batten (Philips make) LED Tube,model no-TMC501 P1xT-LED 22W P3241 (WB I & WD schedule P-113, I- 5:3 F.22)	Nos	3	464.53	1393.59
9	Fixing only single/twin fлуorescent light fitting complete with all accessories directly on wall/ceiling by screws etc.. [PWD Schedule Page No-C-2;Item No-14a]	Nos	3	90.30	270.90
10	Supply & fixing Bulk head light fittings with die cast aluminium housing frosted/clear glass on wall/ceiling incl S/F 9 watt LED Lamp complete set. [Make - Havells] (PWD sch - Page--D-13, I-23)	Nos	3	682.95	2048.85
11	Supply & fixing smart bright street light complete with all accessories to be fixed from the wall of building or on pole incl. making holes /providing clamping arrangement & necy. GI reducer as required.S&F 40 mm GI Pipe 1.5 mtr average length & s&f necy length of 1.5 sqmm pvc insulated single core copper wire & making connections as required & mending good damages incl wall painting. (30 Watt) (Make - Bajaj) [WB I&WD sch P-111, I-f.9.0.2]	Nos	1	3106.48	3106.48

	Supply of 9" domestic metal exhaust fan 9" (225mm) SWEEP, TRANS AIR - (Make-Crompton/Havells/Bajaj) (UD & MA schedule P-14, I-5)	Nos	3	1863.00	5589.00
13	Fixing only exhaust fan after making hole in wall and making good damages and smooth cement finish etc. as practicable as possible and providing necy. length of PVC insulated wire and making connection for exhaust of following diameter: 22.5 cm (9") [PWD Schedule Page No-C-4; Item No-28(b)]	Nos	3	259.35	778.05
14	Fixing only louver shutter/cowl on wall with necy. bolts & nuts (6 mm dia x 62 mm long) For 22.5 cm(9") Exhaust fan [PWD Schedule Page No-C-4; Item No-30(b)]	Nos	3	86.10	258.30
15	Supply of 240V A.C Ceiling Fan (48" sweep, 1200 mm complete) [Make-Crompton [for counter only] (UD & MA schedule P- 23, I- 70)	Each	1	2283.00	2283.00
16	Fixing only Ceiling Fan [PWD sch P- C-3, I-21(a)]	Each	1	69.30	69.30
17	Supply & Fixing 240 V, 16/20 A Piano key type switch (Brand approved by EIC) on sheet metal switch board incl. S & F 100x100x65mm MS (16SWG) switch board and bakelite/perspex top cover of 3mm thick by Brass screws after making housing for switch by cutting bakelite/perspex cover and making necessary connections as required. (For Hand Dryer machine) [PWD sch P- E-6, I-17(b)]	Each	1	211.05	211.05
18	S/F 240V 25A Modular type starter (brand approved by EIC) with 25 A. Modular switch DP MCB (C-Curve) and 4 Module G.I. Modular type switch board with 4 Module Top Cover Plate flushed in wall incl. S/F switch board and Cover Plate and making necy. Connections with PVC Copper wire and earth connectivity wire etc. as per schedule [for Pump] [PWD Schedule Page No-E-19, Item No-17] (Please follow in details)	Nos	1	823.20	823.20
19	Supply and Fixing of 2 mm Polyvinyl glow sign board made of 22 SWG GI sheet box with 1"X1" aluminum channel for fixing the vinyl board after necessary cutting the letter as required & s/f LED tube light fittings along with all accessories. (16 sqft @495.00/sqft) (UD & MA schedule P-14, I-4)	Nos	1	7920.00	7920.00
20	Earthing installation by GI earth Spike (1830 X 20 mm) including 8SWG GI EarthWire & GI nuts, bolts, washer etc.	Nos	1	450.00	450.00
				Total	42080.52
				Add 18% GST	7574.49
				Total With GST (A)	49655.01
				Cess@1%	496.55
				total	50151.56
	Contingency Amount on "A"			Contingency@3%	1489.65
	(Total+GST)=Rs:			Total	51641.21
				Say Rs.	51641
Service Connection Charges as per Quotation					

Pranab R. Das
S. A. E. (C)
English Bazar Municipality
MALDA

Say RS. 51,641.00

[Signature]
Chairman
English Bazar Municipality
MALDA

Technically Vetted Rs. **51,641.00**

(Rupees fifty one thousand six hundred and forty one only.)

[Signature]
09.04.25
Junior Engineer
Electrical & Mechanical Division
SUDA

[Signature]
9.4.25
ASSISTANT ENGINEER
ELECTRICAL & MECHANICAL DIVISION
SUDA

[Signature]
11/4/25
Executive Engineer (E/M)
O/O the Secretary M.E. Dte.
Government of West Bengal

MODEL DRAWING FOR CONSTRUCTION OF C. T./P.T./I.T
TOILET SEATS 2 NOS URINAL 3 NOS
MODLE NO.- F

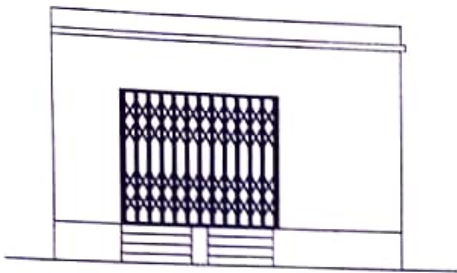

FRONT ELEVATION

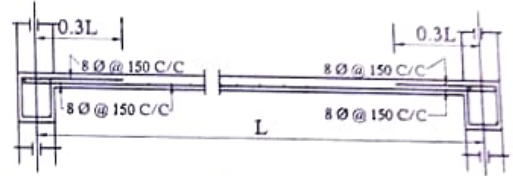
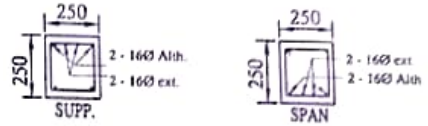

Details Of R.C.C Roof Slab & Beam
(SCALE - 1 : 25)

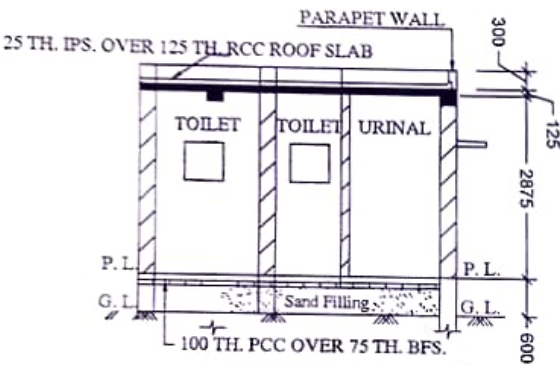

SECTION - 'A - A'

BHLP → 03
TL → 03
EF → 03
OL → 01
CF → 01
GSB → 01

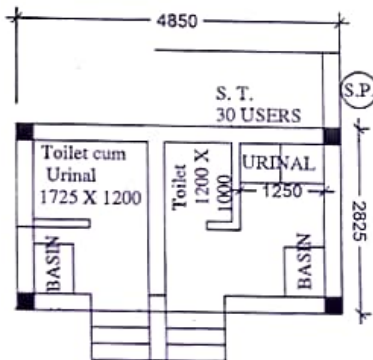

PLAN

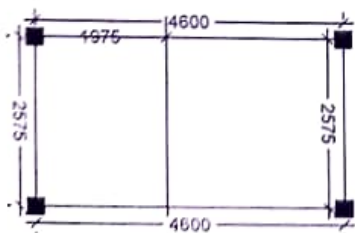

LAYOUT PLAN

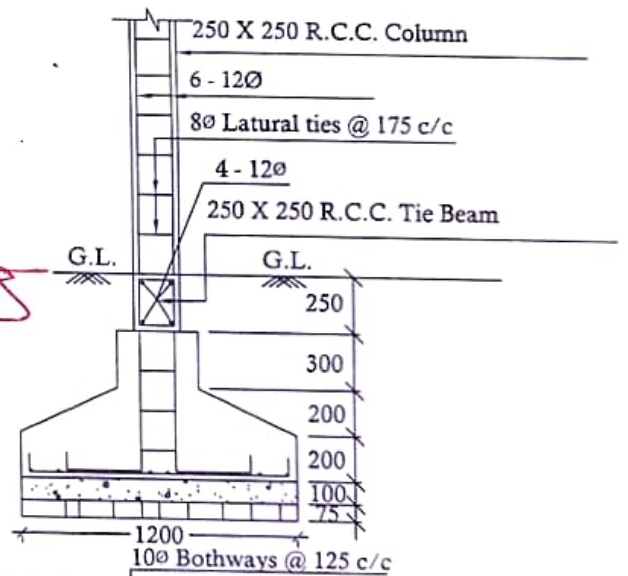

DETAILS OF R. C. C COLUMN
(SCALE - 1 : 25)

Pranab R. Das
S. A. E. (C)

English Bazar Municipality
MALDA

[Signature]
Chairman

English Bazar Municipality
MALDA