

## ESTIMATE FORM

ENGLISHBAZAR MUNICIPALITY, MALDA

Estimate of Civil Works for Construction of Institutional /Public Toilet Block at Barlow Girls' High School (H.S) in Ward No. - 08  
Under Englishbazar Municipality, Malda (W.B). (MODEL NO -A)

Sl. No.	Item Description & Item No.							Quantity	Rate(Rs.)	Unit	Amount(Rs.)
	Details	Count	Nos.	L	B	H	QNTY.				
1	Earth work in excavation of foundation trenches or drains, in all sorts of soil (including mixed soil but excluding laterite or sandstone) including removing, spreading or stacking the spoils within a lead of 75 m. as directed. The item includes necessary trimming the sides of trenches, levelling, dressing and ramming the bottom, bailing out water as required complete. (a) Depth of excavation not exceeding 1,500 mm. PWD Building Works schedule Page - 1, Item -2.a							18.390	11927.00	%Cum	2193.38
	Column	6	1	1.200	1.200	1.125	9.720				
	Main Tie Beam	2	1	7.374	0.250	0.375	1.383				
		3	1	3.775	0.250	0.375	1.062				
	Part Tie Beam	1	1	11.249	0.250	0.400	1.125				
	Reservior (1.2X1.5X1.5)	1	1	1.700	2.000	1.500	5.100				
							18.390				
	(b) Depth of excavation for additional depth beyond 1,500 mm. and upto 3,000 mm. but not requiring shoring.							0.680	19238.00	% Cum	130.82
		1	1	1.700	2.000	0.200	0.680				
2	Single Brick Flat Soling of picked jhama bricks including ramming and dressing bed to proper level and filling joints with local sand.							48.964	322.00	Sqm	15766.41
	Column	6	1	1.200	1.200		8.640				
	Main Tie Beam	2	1	7.374	0.250		3.687				
		3	1	3.775	0.250		2.831				
	Part Tie Beam	1	1	11.249	0.250		2.812				
	Floor	1	1	6.624	3.275		21.694				
	Ramp	1	1	5.900	1.000		5.900				
Reservior	1	1	1.700	2.000		3.400					
						48.964					
3	Ordinary Cement concrete (mix 1:2:4) with graded stone chips (20 mm nominal size) excluding shuttering and reinforcement,if any, in ground floor as per relevant IS codes. Rate Analysis Enclosed							3.905	4521.93	Cum	17658.14
	Column	6	1	1.200	1.200	0.100	0.864				
	Main Tie Beam	2	1	7.374	0.250	0.050	0.184				
		3	1	3.775	0.250	0.050	0.142				
	Part Tie Beam	1	1	11.249	0.250	0.050	0.141				
	Floor	1	1	6.624	3.275	0.075	1.627				
	Ramp	1	1	5.900	1.000	0.075	0.443				
Plinth Protection	1	1	7.374	0.450	0.075	0.249					
	2	1	3.775	0.450	0.075	0.255					
						3.905					
5	25 mm. thick damp proof with cement concrete (1:1.5:3) (with graded stone aggregate 10 mm. normal size) and painting the top surface with a coat of bitumen [VG.40 ] using 1.7 kg. per sq.m. including heating the bitumen and cost and carriage of all materials complete. [Bitument to be supplied by the Agency]							7.924	245.01	Sqm	1941.46
		2	1	7.374	0.250		3.687				
		3	1	3.775	0.250		2.831				
		1	1	11.249	0.125		1.406				
						7.924					
6	Brick work with 1st class bricks in cement mortar (1:6) (a) In foundation and plinth Rate Analysis Enclosed							7.649	4872.88	Cum	37272.66
	GL 2 PL	1	1	26.073	0.250	0.600	3.911				
	Ramp	1	1	7.900	0.250	0.300	0.593				
	Water Reservior	1	1	7.400	0.250	1.700	3.145				
						7.649					



	1	2	22.298		0.150	6.689								
	1	2	11.249		0.150	3.375								
	13	1	0.450	0.300		1.755								
	1	1	7.974	4.375		34.886								
	1	1	24.698		0.125	3.087								
	2	1	2.400	0.600		2.880								
						85.255								
13	Ordinary Cement concrete (mix 1:1.5:3) with graded stone chips (20 mm nominal size) excluding shuttering and reinforcement if any, in ground floor as per relevant IS codes. (i) Pakur Variety [PWD BUILDING WORKS, Page- 26, It. No- 10. i] Rate Analysis Enclosed													
	6	1	1.200	1.200	0.200	1.728								
	6	1	0.800	0.800	0.200	0.768								
	$6*0.15/3*(1*1+0.3*0.3+1*0.3)=0.417$													
	6	1	0.400	0.400	0.300	0.288								
	6	1	0.250	0.250	3.475	1.303								
	2	1	7.374	0.250	0.250	0.922	14.493	5052.35	Cum	73223.71				
	3	1	3.775	0.250	0.250	0.708								
	1	1	11.249	0.250	0.250	0.703								
	1	1	22.298	0.250	0.150	0.836								
	1	1	11.249	0.125	0.150	0.211								
	13	1	0.450	0.300	0.075	0.132								
	2	1	7.374	0.250	0.225	0.830								
	3	1	3.775	0.250	0.225	0.637								
	1	1	7.974	4.375	0.125	4.361								
	1	2	2.400	0.600	0.075	0.216								
	1	1	1.700	2.000	0.125	0.425								
	1	1	1.700	2.000	0.125	0.425								
						14.493								
14	Reinforcement for reinforced concrete work in all sorts of structures including distribution bars, stirrups, binders etc initial straightening and removal of loose rust (if necessary), cutting to requisite length, hooking and bending to correct shape, placing in proper position and binding with 16 gauge black annealed wire at every intersection, complete as per drawing and direction. 10th CORRIGENDA & ADDENDA, Dated: 22.01.2020, Page - 1 of 6, PWD(WB), S.O.R. Volume - I : Building Works w.e.f. 01/11/2017, Item No.-40, Page No. - 43 (a) For works in foundation and upto roof of ground floor/upto 4 m III. OTHER MANUFACTURERS NOT SPECIFIED										1.365	58229.74	M.T.	79483.60
	14.493	0.012	7.85			1.365								
15	Artificial stone in floor, dado, staircase etc with cement concrete (1:2:4) with stone chips, laid in panels as directed with topping made with ordinary or white cement (as necessary) and marble dust in proportion (1:2) including smooth finishing and rounding off corners including raking out joints or roughening of concrete surface and application of cement slurry before flooring works using cement @ 1.75 kg/sq.m all complete including all materials and labour. In ground floor. 3 mm. thick topping (High polishing grinding on this item is not permitted with ordinary cement). Using grey cement (ii) 25 mm. thick							<del>34.89</del> 31.886	243.83	Sqm	8506.25			
	1	1	7.974	4.375		34.886								
16	Neat cement punning about 1.5mm thick in wall, dado, window sill, floor etc. NOTE: Cement 0.152 cu.m per100 sq.m. PWD Building Works schedule, P-192, It. No. 15 (Rate Analysis)							<del>22.5589</del> 22.56	32.72	Sqm	738.13			
	1.000	1.000	22.298		0.600	13.379								
	1.000	1.000	5.400		1.700	9.180								
						22.559								

Chipping of concrete surface before taking up work.							PWD Building	85.26	21.00	Sqm	1790.36
Schedule, P-192, It-1											
as shuttering sl no. 12							85.26				
18	Plaster (to wall, floor, ceiling etc.) with sand and cement mortar including rounding off or chamfering corners as directed and raking out joints including throating, nosing and drip course, scaffolding/staging where necessary (Ground floor).[Excluding cost of chipping over concrete surface] (i) With 1:6 cement mortar (c) 15 mm thick plaster [PWD BUILDING WORKS, Page- 189, It. No- 1. ] Rate Analysis Enclosed										
	Length wise side outer	2	1	7.374		3.900	57.517				
	Breadth wise side outer	2	1	3.775		3.900	29.445				
	Chajja	13	2	0.450		0.300	3.510				
	Chajja Side	13	1	1.050		0.075	1.024				
	Iner Wall 250 mm th.	2	1	6.874		2.750	37.807	242.55	139.48	Sqm	33830.87
	Iner Wall 250 mm th.	4	1	3.275		2.750	36.025				
	Iner Wall 125 mm th.	6	1	1.000		2.875	17.250				
		2	2	3.312		2.875	38.088				
		1	1	1.500		2.875	4.313				
	Less Door	5	-1	0.750		2.100	-7.875				
	Less Collapsible	1	-1	2.050		2.100	-4.305				
	Less Ventilators	13	-1	0.450		0.600	-3.510				
	Parapet wall	1	1	24.698		0.975	24.081				
	Water Reservoir	1	1	5.400		1.700	9.180				
							242.550				
19	Plaster (to wall, floor, ceiling etc.) with sand and cement mortar including rounding off or chamfering corners as directed and raking out joints including throating, nosing and drip course, scaffolding/staging where necessary (Ground floor).[Excluding cost of chipping over concrete surface] (ii) With 1:4 cement mortar (c) 10 mm thick plaster [PWD BUILDING WORKS, Page- 189, It. No- 1. ] Rate Analysis Enclosed										
	Slab bottom	1	1	6.874	3.275		22.512	29.921	124.48	Sqm	3724.57
	Slab extension	1	1	24.698	0.300		7.409				
							29.921				
20	Supplying, fitting and fixing fibre reinforced polymer (FRP) Composite door frame as per approved section with glass fibre reinforced plastic moulded skins and a special sandwich core, so as to impart monolithic composite structure as per approved technology of Department of Science and Technology (DST) to satisfy IS: 4020 door testing performance criteria.. (i) 66mm x 90mm PWD Building Works schedule, P-115, It - 3 (i)										
		5	1	4.95			24.750	24.75	497.00	Mtr	12300.75
21	Supplying, fitting & fixing fibre reinforced polymer (FRP) Composite door shutters as per approved design with glass fibre reinforced plastic moulded skins and a special sandwich core, so as to impart monolithic composite structure as per approved technology of Department of Science and Technology (DST) to satisfy IS:4020 door testing performance criteria. In ground floor. (ii) 32 mm thick [PWD BUILDING WORKS, Page- 125, It. No- 14.ii ]										
		5	1	2.100	0.750		7.880	7.88	2763.00	Sqm	21772.44
22	Anodised aluminium barrel / tower / socket bolt (full covered) of approved manufactured from extruded section conforming to I.S. 204/74 fitted and fixed with cadmium plated screws . (vii) 225mm long x 10mm dia. bolt. PWD Building Works schedule, P-144, It No. 26 (vii)										
		5	1	2.00			10.000	10.00	84.00	Each	840.00
23	Iron butt hinges of approved quality fitted and fixed with steel screws, with ISI mark. (viii) 100mm X 75mm X 3.50mm. PWD Building Works schedule, P-140, It No. -5 (viii)										
		5	1	3.00			15.000	15.00	66.00	Each	990.00

	Aluminium decorative handle (hexagonal / fluted) of approved quality fitted complete. (i) 150mm plate x 10mm dia rod x 12mm hexagonal/fluted. PWD Building Works schedule, Page -146 . Item no-31,(i)						10.00	87.00	Each	870.00
		5	1	2.00			10.000			
25	Iron hasp bolt of approved quality fitted and fixed complete (oxidised) with 16mm dia rod with concrete bolt and round fitting. .b)250mm long. PWD Building Works schedule, Page -141 . Item no-10 b)						5.00	159.00	Each	795.00
		5	1	1.00			5.000			
26	(A) Supplying Aluminium casted body hydraulic door closer as per I.S.I. SOR, PWD, P- 244, I - 13(a)						1.00	635.00	Each	635.00
		4	1	1.00			1.000			
27	Rendering the Surface of walls and ceiling with White Cement base WATER PROOF wall putty of approved make & brand.(1.5 mm thick) In Ground Floor PWD Building Works schedule, PWD, P- 198, I - 5									
	Iner Wall 250 mm th.	2	1	6.874		0.775	10.655			
	Iner Wall 250 mm th.	4	1	3.275		0.775	10.153			
	Iner Wall 125 mm th.	6	1	1.000		0.775	4.650			
		2	2	3.312		0.775	10.267			
		2	1	1.500		0.775	2.325			
	Ceiling	1	1	6.624	3.275		21.694			
	Less Ventilators	13	-1	0.450		0.600	-3.510			
							56.234			
28	Acrylic Distemper to interior wall, ceiling with a coat of solvent based interior grade acrylic primer (as per manufacturer's specification) including cleaning and smoothing of surface. Two Coats PWD(WB), S.O.R. Volume- I : Building Works w.e.f. 01/11/2017, Item No.-10, Page No. - 196						56.234	70.00	Sqm	3936.38
	Same as Item - Wall putty						56.234			
29	Applying Exterior grade Acrylic primer of approved quality and brand on plastered or concrete surface old or new surface to receive decorative textured (matt finish) or smooth finish acrylic exterior emulsion paint including scraping and preparing the surface throughly, complete as per manufacturer's specification and as per direction of the EIC. In Ground Floor:									
	Length wise side outer	1	1	7.374		3.900	28.759			
	Breadth wise side outer	2	1	3.775		3.900	29.445			
	Chajja	13	2	0.450		0.300	3.510			
	Chajja Side	13	1	1.050		0.075	1.024			
	Less Ventilators	13	-1	0.450		0.600	-3.510			
	Parapet wall	1	1	24.698		0.975	24.081			
							83.309			
30	Protective and Decorative Acrylic exterior emulsion paint of approved quality, as per manufacturer's specification and as per direction of Engineer-in-Charge to be applied over acrylic primer as required. The rate includes cost of material, labour, scaffolding and all incidental charges but excluding the cost of primer. In Ground floor (Two Coat) a) Normal Acrylic Emulsion [PWD BUILDING WORKS, Page- 197, It. No- 17.c]						83.309	67.00		5581.70
	Same as Item No						83.309			
31	Collapsible gate with 40mm x 40mm x 6mm Tee as top and bottom guide rail, 20mm x 10mm x 2mm vertical channels 100mm apart in fully stretched position 20mm x 5mm M.S. flats as collapsible bracings properly rivetted and washered including 38mm steel rollers including locking arrangements, fitted and fixed in position with lugs set in cement concrete and including cutting necessary holes, chasing etc. in walls, floors etc. and making good damages complete. In ground floor. P-106 Item-18 (3rd Corrigendam Page No 92)						4.830	4351.00	Sqm	21015.33
	Gate	1	1	2.30		2.10	4.830			

<p>d. Ornamental grill of approved design joints          Fully welded with M.S, W.I. Flats and bars of windows, railing etc. fitted and          with necessary screws and lugs in ground floor..          Grill weighing above 10 Kg./sq.mtr and up to 16 Kg./sq. mtr.          PWD Building Works schedule, P-104 Item-13 A (i) (3rd Corrigendam Page No 91)</p>							1.699	10021.00	Qntl	17027.68
Grill	13	1	0.600	0.450	3.510					
Box for pump	1	5	0.600	0.600	1.800					
Railing	1	1	5.900	0.900	5.310					
					10.620					
				@16 kg/ sqm. =	169.920					
				=	1.699					
33	<p>a) Priming one coat on steel or other metal surface with synthetic oil bound primer of approved quality including smoothening surfaces by sand papering etc.          PWD Building Works schedule, P/200 Item-1(a)</p>					25.065	29.00	Sqm	726.89	
C gate	1.5	1.000	2.300	2.100	7.245					
Grill	2	10.000	0.600	0.450	5.400					
Box for pump	5	1.000	0.600	0.600	1.800					
Railing	2	1.000	5.900	0.900	10.620					
					25.065					
34	<p>(A) Painting with best quality synthetic enamel paint of approved make and brand including smoothening surface by sand papering etc. including using of approved putty etc. on the surface, if necessary :          (b) On steel or other metal surface :          (iv) Two coats (with any shade except white)          PWD Building Works schedule, P-200 Item-2(b)(iv)</p>					25.065	79.00	Sqm	1980.14	
	Same as priming on grill									
35	<p>Supplying and laying true to line and level Anti-Skid, Full Body, Homogeneous &amp; Granular finish Vitrified Tiles conforming to IS:15622-2006 &amp; IS 4457-2007 and testing shall be made in accordance with IS:13630 [Non- modular sizes for tiles with Skid resistance &gt; 0.5, Mohr's hardness &gt; 5.0, Staining resistance: Class-1, Water Absorption: E &lt; 0.5%], MOR &gt; 35 N/sq.mm in Internal area of building e.g. Toilet Block, Passage, Corridor, Accessible Open Terrace etc. set in 20 mm sand cement mortar (1:4) and 2 mm thick cement slurry at back side of tiles using cement @ 2.91 Kg./Sqm or using Polymerised Adhesive (6 mm thick layer applied directly over finished artificial stone floor/ Mosaic etc without any backing course) laid after application slurry using 1.75 Kg of cement per Sqm below mortar only, joints grouted with admixture of white cement and colouring pigment to match with colour of tiles/ epoxy grout materials of approved make as directed and removal of wax coating of top surface of tiles with warm water and polishing the tiles using soft and dry cloth upto mirror finish complete including the cost of materials, labour and all other incidental charges complete true to the manufacturer's specification and direction of Engineer-in-Charge. (White cement, synthetic adhesive and grout material to be supplied by the contractor).          b) In Ground Floor: Sizes-600 mm x600mm x10 mm with breaking strength &gt;1500 N           3rd CORRIGENDA &amp; ADDENDA, Dated: 04.06.2018, Page 80 of 96, PWD(WB), S.O.R. Volume - I : Building Works w.e.f. 01/11/2017, Item No.-1, Page No. - 280</p>					21.69	1589.00	Sqm	34465.41	
	floor									
		1	6.624	3.275	21.690					
36	<p>Supplying, fitting &amp; fixing best quality digital printed Ceramic tiles in coloured decorative on walls and floors to match with the existing work &amp; 4 nos. key stones (10mm) fixed with adhesive 4.5mm thick at the back of each tile &amp; finishing the joints with white cement mixed with colouring oxide if required to match the colour of tiles including roughening of concrete surface, if necessary or by synthetic adhesive &amp; grout materials etc. With polymerised adhesive and epoxy grout pointing including spacer-2mm (When tiles are laid over existing hard ready surface) all complete as per direction of Engineer-in-charge.          [PWD BUILDING WORKS, Page- 68, It. No- 39]</p>					84.74	1060.00	Sqm	89826.52	
	inside 250 mm wall	2	1	6.624	2.1					27.821
		4	1	3.275	2.1					27.510
	Less C Gate	1	-1	2.05	2.1					-4.305
	below urinal	2	1	1.95	0.3					1.170
	on 125 mm wall	3	2	1.00	2.1					12.600
		2	2	3.312	2.1					27.821

	5	-1	0.75	2.1		-7.875				
						84.742				
	Supplying & laying 20 mm designer chequered tiles of any shade and of approved quality as per IS: 1237: 1980 laid in patterns as directed in pavement, footpath including necessary underlay 25 mm thick average cement mortar (1:3) complete in all respect with all labour and materials [using cement slurry @ 4.4 kg/Sq.m at back side of tiles. Cement of mortar & slurry will be supplied by the Department. Border concrete if necessary to be paid separately].						5.90	825.00	Sqm	4867.50
	3rd CORRIGENDA & ADDENDA, Dated: 04.06.2018, Page 37 of 96, PWD(WB), S.O.R. Volume - I : Building Works w.e.f. 01/11/2017, Item No.-47, Page No. - 74									
	Ramp	1	1	5.900	1	5.900				
38	Supplying, fitting & fixing granite slabs 15mm to 18 mm. thick with uniform texture & without decorative veins in columns, wall, fascia, rise etc. with 15 mm thick [avg] cement mortar (1:2) including making suitable arrangements to hold the stones properly by brass / copper hooks including pointing in cement mortar (1:2) (1 white cement : 2 marble dust) with admixture of pigment matching the stone shades all complete as per direction of the Engineer-in-charge including cost of all materials, labours, scaffolding, staging, curing and roughening of concrete surface complete. [Using cement slurry at back side of granite @ 4.4 kg/sq.m & white cement slurry for joint filling @ 1.8 kg/sq.m] In ground floor (a) Area of each Granite slab 0.6 to 1.0 Square meter. PWD Building Works schedule, page-63, Item:33(a)- ( 3rd Corrigendam ,Page 37)						13.340	2315.00	Sqm	30882.10
	For Wash Basin (Gents)	1	1	2.400	0.450	1.080				
	For Wash Basin (Ladies)	1	1	2.400	0.450	1.080				
	for front wall	1	1	7.374		2.100	15.485			
	less collapsable	1	1	-2.050		2.100	-4.305			
							13.340			
39	Supplying, fitting and fixing 18 mm thick marble partition slab with chawk doongri marbel square cut, both sides polished with two front corners rounded and edges polished. Sanitary and plumbing work schedule P-81, It-13						2.16	1426.00	Sqm	3080.16
		3	1	1.2		0.6	2.16			
40	Supplying bubble free float glass of approved make and brand conforming to IS: 2835-1987. iv) 5mm thick coloured / tinted / smoke glass. PWD Building Works schedule. P-243, I -9						3.51	585.00	Sq.M.	2053.35
		13	1	0.6	0.45		3.510			
41	Supplying and Planting of different plant / trees ( Supplying well grown plants bushy and healthy, minimum height as specified i.e. exposed height including all leads & lift, carriage, handling, manuring, applying presticide and fertilizer etc. . i) Furcaria veriegated 10-12 leaves in height 20-30cm in earthen pots of size 25cm. PWD Building Works schedule, Page -261, It- 9 (i)						12	162.00	Each	1944.00
42	x) Ficus blakii (F. Vivicon) well branched (Bushy) of height 120cm - 135 cm in earthen pot of size 30cm. PWD Building Works schedule, Page -261, It- 9 (x)						9	187.00	Each	1683.00
43	xxvi) Areca Palm 4 - 5 suckers of height 90 cm to 105 cm in earthen pots of size 25 cm. PWD Building Works schedule, Page -261, It- 9 (xxvi)						6	127.00	Each	762.00
44	Supplying, fitting and fixing Anglo-Indian W.C. in white glazed vitreous china ware of approved make complete in position with necessary bolts, nuts etc. a) With 'P' trap (with vent) Schedule, page-79, item no -3 (a) PWD S&P						5	3104.00	Each	15520.00
45	Supplying, fitting and fixing Closet seat of approved make with lid and C.P. hinges, rubber buffer and brass screws complete. (b) Anglo Indian (i) Plastic (hallow type) black [SANITARY AND DRAINAGE WORKS, Page- 81, It. No- 10. b.i]						5	371.00	Each	1855.00

	Supplying and fixing Flat back urinal (half stall urinal) in white vitreous of approved make in position with brass screws on 75 mm X 75 mm X 75 mm wooden blocks complete.		3	2869.00	Each	8607.00
	Supplying, fitting and fixing Squating plate with integral flushing in white vitreous chinaware of approved make in cement concrete (6:3:1) with ghama chips complete. (Payment of concrete will be paid seperately). (i) 450 mm X 350 mm Schedule, (P - 80, Item. No. - 7 ,	PWD S&P	3	881.00	Each	2643.00
48	Supplying, fitting and fixing 10 litre porcelain low-down cistern of approvedmakewitheither sideor bottominlet, sideoverflow, brackets complete with all internnal PVC fittings. White [SANITARY AND DRAINAGE WORKS, Page- 36, It. No- 11]		5	2297.00	Nos	11485.00
49	Supplying,fitting and fixing 32 mm dia. Flush Pipe of approved make with necessary fixing materials and clamps complete. i) Polythene Flush Pipe S&P Schedule, Page no 81. Item no. 11(i)	PWD	5	155.00	Each	775.00
50	Supplying, fitting and fixing urinal flush pipe fittings of approved brand. (a) C.P. urinal flush pipe fittings range of one PWD S&P Schedule, S.P.81,item-12/a		3	414.00	Each	1242.00
51	Supplying, fitting and fixing white vitreous china best quality approved make wash basin with C.I. brackets on 75 mm X 75 mm wooden blocks, C.P. waste fittings of 32 mm dia., mending good all damages and painting the brackets with two coats of approved paint. (ii) 630 mm X 450 mm size S&P Schedule, P-41, It 2 (iii)	PWD	4	3260.00	Each	13040.00
52	Supplying,fitting and fixing approved brand P.V.C. CONNECTOR white flexible, with both ends coupling with heavy brass C.P. nut, 15 mm dia., (iii) 600 mm long S&P Schedule, Page No.-43 Item No.-9-iii PWD,	PWD	7	107.00	Each	749.00
53	Supplying,fitting and fixing approved brand 32 mm dia.P.V.C. waste pipe, with PVC coupling at one end fitted with necessary clamps. (iv) 1050 mm long each PWD S&P Schedule, Page No.-43 Item No. 10-iv		7	91.00	Each	637.00
54	(f) Hand Shower(Health Faucet) with 1mtr Flexible Tube with Wall Hook(Equivalent to Code No.573 & Model -ALLIED of Jaquar or similar). PWD S&P Schedule, Page No.-3 Item No.- 3 f,		5	1251.00	Each	6255.00
55	(ii) Chromium plated Bib Cock long body with wall flange with aerator (Equivalent to Code No. 512 & Model- Tropical / Sumthing Special of ESSCO or similar brand) [SANITARY AND DRAINAGE WORKS, Page- 6, It. No- 7. a.ii]		9	659.00	Each	5931.00
56	(b) (i) Chromium plated Stop Cock (Equivalent to Code No. 513(A) & 513(B) & Model - Tropical / Sumthing Special of ESSCO or similar PWD S&P Schedule, Page No.-6 Item No.-7-b-i		9	493.00	Each	4437.00
57	Supplying, fitting and fixing shower of approved brand and make. (ii) Chromium plated round shower with revolving joint (Equivalent toCode No. 541(N) & Model - Tropical / Sumthing Special of ESSCO or similar brand). PWD S&P Schedule, Page No.-3 Item No.-3- a-ii		5	360.00	Each	1800.00
58	(iii) Chromium plated shower arm 240 mm long (Equivalent to Code No. 536(A) & Model - Tropical / Sumthing Special of ESSCO or similar brand). Page No.-3 Item No.-3-a-(iii), PWD,VOL-II , 2017-18		3	309.00	Each	927.00
59	Chromium plated angular Stop Cock with wall flange (Equivalent to Code No. 5053 & Model - Florentine of Jaquar or similar brand). PWD S&P Schedule, Page No.-6 Item No.-7-d-i,		12	815.00	Each	9780.00
60	Supplying, fitting and fixing pillar cock of approved make. a) (i) CP Pillar Cock - 15 mm. (Equivalent to Code No. 507 & Model - Tropical / Sumthing Special of ESSCO or similar brand). (P. No. - 45, Item. No. - 19(a)i, Pwd Sanitary Plumbing Schedule 2017)		5	555.00	Each	2775.00

61	Supplying and fixing PVC pipes of approved make of Schedule 80 (medium duty) conforming to ASTM D - 1785 and threaded to match with GI Pipes as per IS : 1239 (Part 1) with all necessary accessories, specials viz. socket, bend, tee, union, cross, elbow, long screw, reducing socket, reducing tee, short piece etc. fitted with holder and clamps, including cutting pipes, making threads, fitting, fixing etc. complete in all respects including cost of all necessary fittings as required, jointing materials and two coats of painting with approved paint in any position above ground. (Payment will be made on the centre line measurements of total pipe line including all specials. No separate payment will be made for accessories, specials. Payment for painting will be made separately) PVC Pipes, 25 mm 12 Item No.-19-i(a), PWD, VOL-II, 2017-18	(a) For Exposed Work Page No.-	35	177.00	Mtr	6195.00
	(a) (a) For Exposed Work 15 mm No.-19-i(a), PWD, VOL-II, 2017-18	PVC Pipes, Page No.-12 Item	20	101.00	Mtr	2020.00
	(b) For Concealed Work mm i(b), PWD, VOL-II, 2017-18	PVC Pipes, 15 Page No.-12 Item No.-19-	20	137.00	Mtr	2740.00
62	Supplying and fitting fixing of gunmetal wheel valve of approved brand and make tested to 21 Kg per sq. cm. 25 mm dia (E5) PWD S&P Schedule, P-5 It-5,vii),		3	778.00	Each	2334.00
63	Supplying P.V.C. water storage tank of approved quality with closed top with lid (Black) - Multilayer (b) 1000 litre capacity S&P Schedule, page.37,item no-6 (b)	PWD	2	5128.00	Each	10256.00
64	Labour for hoisting plastic water storage tank. capacity. PWD S&P Schedule, page.37,item no-10 (i)(a)	(i) Upto 1500 litre (a) Upto 1st story from G.L.	2	96.00	Each	192.00
65	Labour for punching hole in plastic water storage tank upto 50 mm dia. PWD S&P Schedule, (P. No. - 38, Item. No. - 13		4	19.00	Each	76.00
66	Supply of UPVC pipes (B Type) & fittings conforming to IS-13592-1992.(A) (i) Single Socketed 3 Meter Length, (b) 110 mm PWD S&P Schedule, Page No.-68 Item No. 23,(A)(i)(b)		30	292.00	Mtr	8760.00
	(B) Fittings Coupler, (b) 110 mm	(i)	15	85.00	Each	1275.00
	(ii) Plain Tee, (b) 110 mm		12	85.00	Each	1020.00
	(iii) Door Tee, (b) 110 mm		9	195.00	Each	1755.00
	ix) Bend 45°, (b) 110 mm		9	89.00	Each	801.00
	xi) Door Bend (T.S.), (b) 110 mm		7	147.00	Each	1029.00
	xvi) Pipe Clip, (b) 110 mm		30	21.00	Each	630.00
	xvii) W.C. Connector (150 mm long) 125 X 110(W/WC Ring) 75 mm		6	142.00	Each	852.00
	xxxii) Plain Floor Trap with Top tile & Strainer 75 mm		6	144.00	Each	864.00
	L) Rubber Ring, (b) 110 mm		30	17.00	Each	510.00
	C) Rubber Lubricant 500 ML		5	187.00	500 ML	935.00
	D) Solvent Cement 250 ML		5	103.00	250 ML	515.00
67	Labour for fitting and fixing U.P.V.C. pipes for above ground work including cost of jointing materials etc. fitting and fixing all necessary specials, cutting pipes, cutting holes in total pipeline including specials. (B) Under ground, (ii) 110 mm dia. PWD S&P Schedule, (P. - 74, Item. No. - 24 (B)		30	84.00	Mtr	2520.00

	ing & fixing UPVC pipes A- Type and fittings conforming to IS:13592-1992 necessary clamps nails, including making holes in walls, floor etc. cutting in any soil through masonry concrete structures etc if necessary and mending damages including joining with jointing materials (Spun Yarn, Amoid/Bitumen/M-Seal etc) complete. A) UPVC Pipes: (i) 75 mm. Dia. (P. - 212, Item. No. - 21 (A)(i) , (B),(c),(i) & (B), (d),(i), Pwd volume-i, 2017)	12	188.00	Mtr	2256.00
	B) UPVC Fittings: c) Bend 87.5 degree (i) 75 mm. Dia.	4	84.00	Mtr	336.00
	B) UPVC Fittings: d) Shoe (i) 75 mm. Dia.	4	78.00	Mtr	312.00
69	Constructing Inspection pit of inside measurement 600mm X 600mm X upto 600mm (depth) with 250 mm thick 1st. class brick work in cement mortar (1:4) on all sides, bottom of the pit consisting of 100 mm thick cement concrete (1:3:6) with stone chips over a layer of jhama brick flat soling, 15 mm thick (1:4) cement plaster to inside walls and out-side walls upto G.L. and 20 mm.thick (1:4) plaster to bottom of the pit, providing necessary invert with cement concrete (1:3:6) with stone chips as per direction, neat cement finishing to entire internal surfaces, top of the pit covered with 100 mm thick R.C.C. slab (1:1.5:3) with stone chips and necessary reinforcements upto 1% and shuttering including 6 mm thick cement plaster (1:4) in all external surfaces of the slab and one 560 mm dia. R.C.C. manhole cover of approved make supplied, fitted and fixed in the slab with necessary fittings, necessary earthwork in excavation in all sorts of soil, filling sides of the pit with earth and removing spoils after work complete in all respect with all costs of labour and materials. i) With Pakur variety.(OTHER MANUFACTURES NOT SPECIFIED) 7th CORRIGENDA & ADDENDA, Dated: 22.01.2020, Page 1 of 7, PWD(WB), S.O.R. Volume - II : Sanitary & Plumbing Works w.e.f. 01/11/2017, Item No. - 1, Page No.- 87	2	6648.00	Each	13296.00
70	Construction of septic tank of different capacities as per approved drawing with 1st class brick work in cement mortar (1:4) including two 560 mm dia. R.C.C. manhole cover(heavy type)of approved make supplied, fitted and fixed in the 100mm thick R.C.C (1:1.5:3) top slab with necessary fittings, 20mm thick cement plaster (4 : 1) with neat cement finish to the internal surfaces and 15 mm thick cement plaster (4 : 1) to outside wall upto 200 mm below G.L floor finished with 25 mm thick grey artificial stone over 100 mm thick R.C.C(1:1.5:3) bottom slab including supplying, fitting and fixing all necessary specials, fittings, S.W. tees, C.I. foot rest etc. including excavation earth in all sorts of soil, shoring, bailing out and pumping out water as necessary, ramming, dressing the bed and refilling the sides of the tanks with earth, removing spoils, filling up the chamber with clear water, removing foreign materials from the chamber and including constructing attached inspection pit as per approved drawing and connecting all necessary pipes, joints etc. with internal plaster work and artificial stone flooring is to be done with admixture of water proofing compound @ 0.5% by weight of cement with all costs of labour and materials. Note:- (i) Finished level of Septic Tank should be 400 mm. from Ground Level. (ii) Height of 50 mm Ventilation pipe & Mosquito proof mesh, should be followed as per IS:2470,Part- I.Payment will be made separately on the basis of actual height based on relevant I.S.Code. 7th CORRIGENDA & ADDENDA, Dated: 22.01.2020, Page 3 of 7, PWD(WB), S.O.R. Volume - II : Sanitary & Plumbing Works w.e.f. 01/11/2017, Item No. - 3, Page No.- 88 (iii) For 30 users i) With Pakur variety.(OTHER MANUFACTURES NOT SPECIFIED)	1	58772.00	Each	58772.00
71	Construction of circular soak well 2.5 metre deep in all types of sandy soils with dry brick work upto 1.6 metre from the bottom having 150 mm intermediate cement brick work (1:4) band all round and cement brick work (1:4) upto 0.90 metre from top with 20mm thick cement plastering (1:4) to inside face upto the depth of cement brick work, 15mm thick cement plaster (1:4) on outer face from top of the well upto G.L. and 6 mm thick cement plaster (1:4) on top of the R.C.C. cover slab including filling bottom 1.00 metre of inside of the well with brick metal (50 mm to 63 mm size) including R.C.C. cover slab of 100 mm thick with cement conc (1:1.5:3) with stone chips with necessary reinforcement and shuttering including one 560 mm dia. R.C.C. manhole cover (heavy type)of approved make supplied, fitted and fixed in the cover slab with necessary fittings, making necessary arrangements for pipe connections, excavation of well including shoring, dewatering and removing the excess earth from the premises as per direction complete in all respect with all costs of labour and materials. With 250 mm thick dry brick work and 250 mm thick cement brick work (1:6) and 1.00m inside dia. 7th CORRIGENDA & ADDENDA, Dated: 22.01.2020, Page 6 of 7, PWD(WB), S.O.R. Volume - II : Sanitary & Plumbing Works w.e.f. 01/11/2017, Item No. - 4, Page No.- 89 For-OTHER MANUFACTURES NOT SPECIFIED)	1	15451.00	Each	15451.00

	Supplying and fixing towel rail with two brackets. brass (ii) 25 mm dia. and 600 mm long P Schedule, p No 82 I No- 22 (a)(ii)	5	430.00	Each	2150.00
	Supplying, fitting and fixing cast iron raised rain proof tank cover 500 mm dia. with locking arrangements (weighing not less than 12 kg). PWD S&P Schedule, . page-37,item no -8	1	1263.00	Each	1263.00
74	Supplying, fitting and fixing bevelled edged mirror 5.5 mm thick silver red as per I.S. 3438 / 1965 together with brass C.P. hinges. (ii) 600 mm X 450 mm PWD S&P Schedule, P-81, It-15(ii)	6	484.00	Each	2904.00
75	Supplying, fitting and fixing soap holder. (b) Fibre glass Sanitary and plumbing work schedule P-82, It-18(b)	10	58.00	Each	580.00
76	Supplying, fitting and fixing porcelain toilet paper holder of approved make with wooden spindle as necessary. (i) Roll type size 250 mm X 125 mm (A5) Sanitary & Plumbing works p No 83 I No- 23 9i)	5	293.00	Each	1465.00
77	Supplying, fitting and fixing glass shelf with aluminium guard rails. (a) Ordinary type with 5.5 mm sheet glass (i) 450 mm X 125 mm Sanitary and plumbing work schedule P-81, It-16(a)(i)	5	341.00	Each	1705.00
Sub Total Of (A)					917966.69
			Add S.G.S.T. @	9%	82617.00
			Add C.G.S.T. @	9%	82617.00
Cost Of Civil & Sanitary Work					1083200.69
			Add L.W.C. @	1%	10832.01
Total payable Amount Including L.W.C.					1094032.70
Add Contengency @3%					32496.02
Total payable Amount Including L.W.C. and contengency					1126528.72
Say Rs.					1126529.00

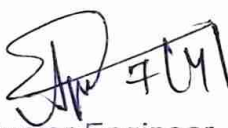
  
Junior Engineer  
Malda Division  
M. E. Directorate  
Govt. of West Bengal

  
Assistant Engineer  
Malda Division  
M.E. Directorate  
Dept. Of U.D & MA  
Govt. Of West Bengal

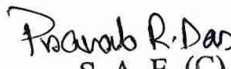
  
S. A. E. (C)  
English Bazar Municipality  
MALDA

  
Chairman  
English Bazar Municipality  
MALDA

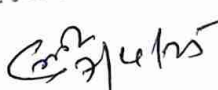
Vetted  
  
Executive Engineer  
Malda Division  
M.E. Directorate  
Dept. Of UD & MA  
Govt. Of West Bengal

MODEL DRAWING FOR CONSTRUCTION OF C. T./P.T.  
 Toilet Seats - 5 Nos Urinal 5 Nos  
 MODEL NO.- A

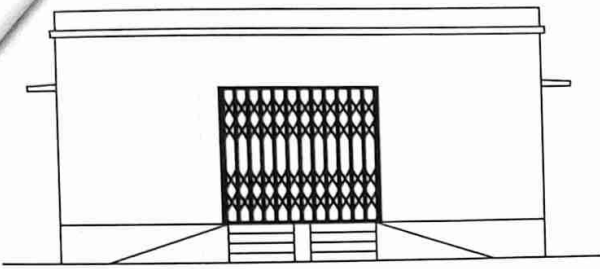

FRONT ELEVATION

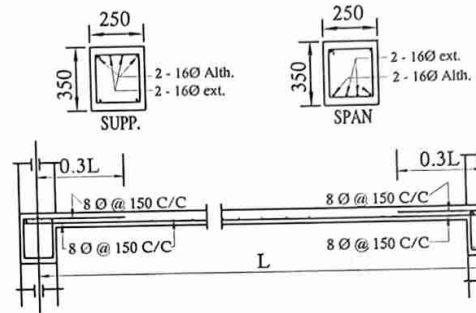

Details Of R.C.C Roof Slab & Beam  
 (SCALE - 1 : 25)

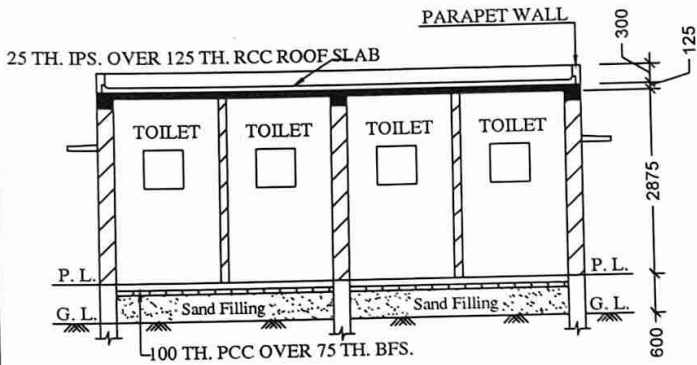

SECTION - 'A - A'

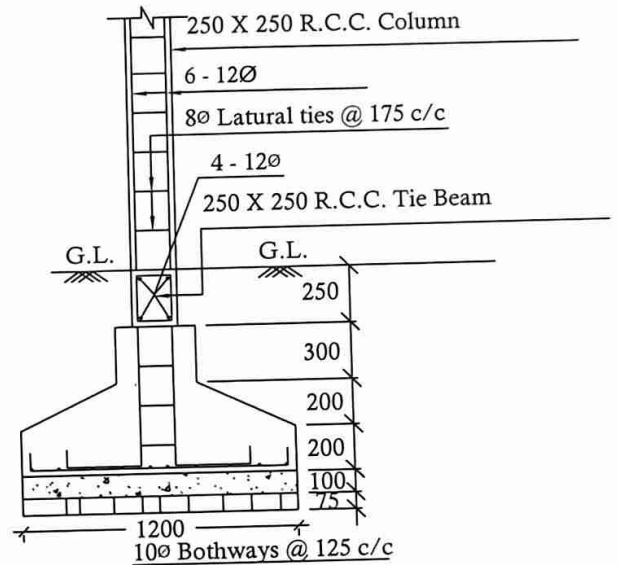

DETAILS OF R. C. C COLUMN  
 (SCALE - 1 : 25)

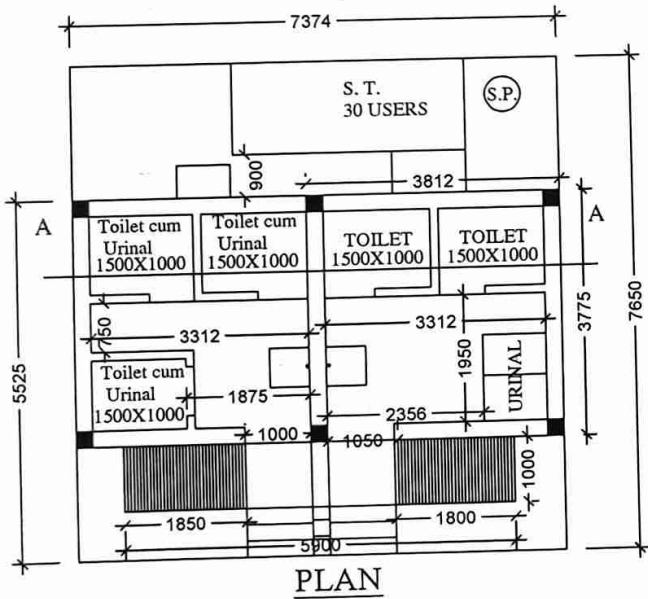

PLAN

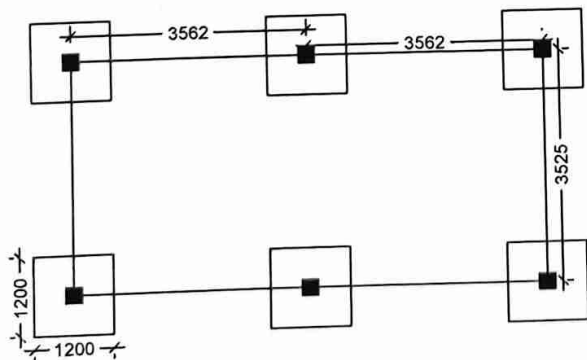

LAYOUT PLAN

*Pranab P. Das*  
 S. A. E. (C)  
 English Bazar Municipality  
 MALDA

*[Signature]*  
 Assistant Engineer  
 Malda Division  
 M.E. Directorate  
 Govt. of West Bengal

*[Signature]*  
 Chairman  
 English Bazar Municipality  
 MALDA

# SEPTIC TANK - 30 Litres

## SECTION (C) - V :- DRAWING OF SEPTIC TANK

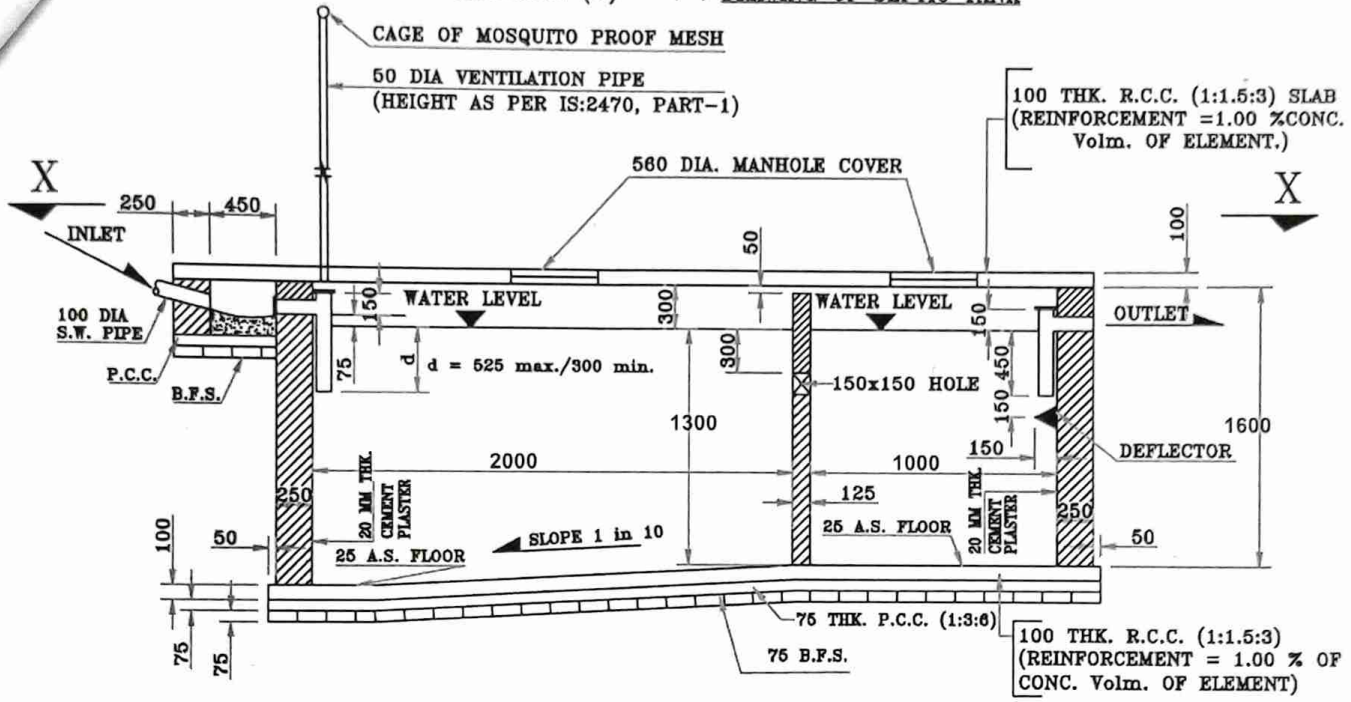

## SECTION ON ' YY ' ,

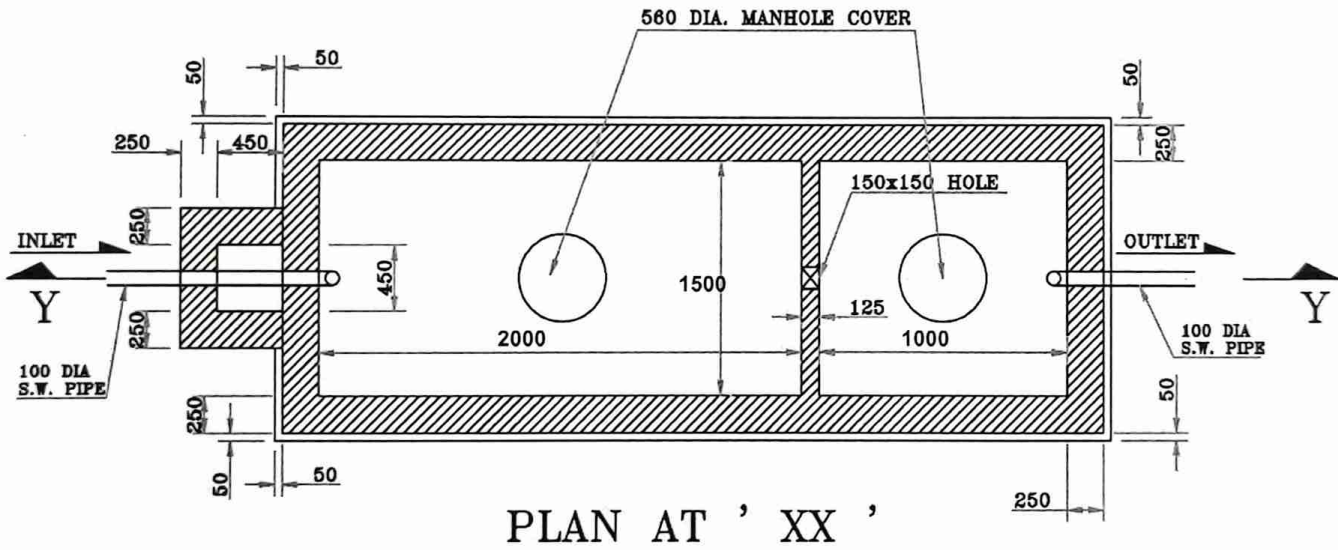

## DETAILS OF SEPTIC TANK

SCALE :- 1 : 50

ALL DIMENSIONS ARE IN MM

Pranab Ran  
S. A. E. (C)  
English Bazar Municipality  
MALDA

*[Signature]*  
Assistant Engineer  
Malda Division  
M.E. Directorate  
Dept. Of UD & MA  
Govt. Of West Bengal

# CIRCULAR SOAK WELL

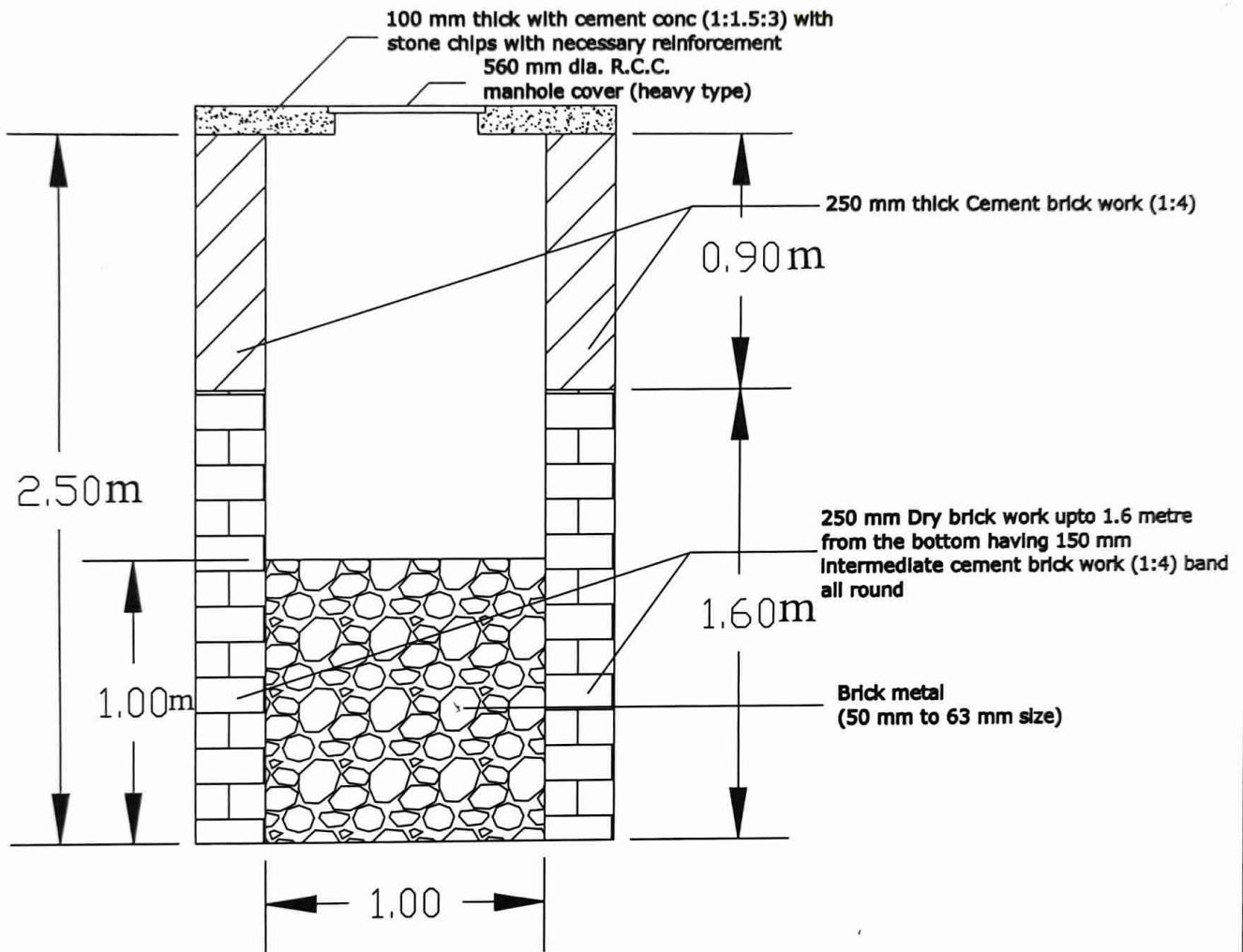

Note:- 20mm thick cement plastering (1:4) to inside face upto the depth of cement brick work, 15mm thick cement plaster (1:4) on outer face from top of the well upto G.L. and 6 mm thick cement plaster (1:4) on top of the R.C.C. cover slab.

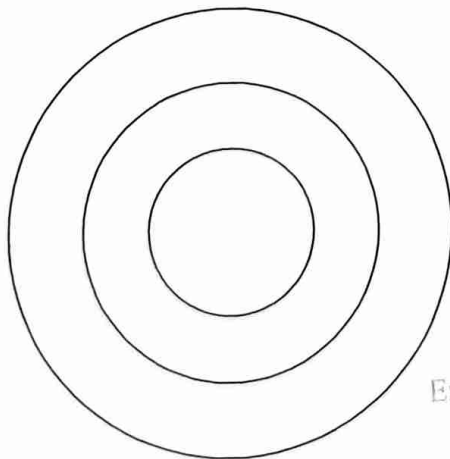

*Pramab R. Das*  
S. A. E. (C)  
English Bazar Municipality  
MALDA

*[Signature]*  
Assistant Engineer  
Malda Division  
M.E. Directorate  
Dept. of UD & MA  
Govt. of West Bengal

**ENGLISHBAZAR MUNICIPALITY, MALDA**

Rate of Non Schedule Items for Construction of Institutional /Public Toilet Block at Barlow Girls' High School (H.S) in Ward No. - 08 Under Englishbazar Municipality, Malda of West Bengal (MODEL NO -A)

SL NO.	Description of Items	Unit	Quantity	Rate (Rs.)	Amount (Rs.)
1	Standard plastic Dustbin(12lits)	Each	5	350.00	1750.00
2	Air Freshner (Pack of 4 nos)	Each	8	216.00	1728.00
3	Air Freshner (Napthaline 250gm)	Each	5	210.00	1050.00
4	Supplying paper napkin	Each	5	50.00	250.00
5	Supplying Sanitary Napking (Whisper or similar make 50 pcs)	Each	4	520.00	2080.00
6	Harpic (Blue 500ml)	Each	4	300.00	1200.00
7	Harpic (Red 500ml)	Each	4	150.00	600.00
8	Gala double lip floor wiper	Each	4	350.00	1400.00
9	Colin glass or surface cleaner	Lit	2	200.00	400.00
10	Muriatic acid	Lit	2	145.00	290.00
11	Bleaching powder	kg	4	120.00	480.00
12	Dettol, Lifeboy or similar make liquid soap	Lit	8	140.00	1120.00
13	Rubber hand gloves	pair	6	80.00	480.00
14	Double Side plastic brush	Each	6	125.00	750.00
15	Plastic Broom	Each	4	170.00	680.00
16	Glow sign board Name and contact details of the following are displayed prominently – Toilet identification number , name of ULB under whose jurisdiction toilet is covered , ward number and maintainance authority prominently displayed for each toilet block supervisor , Supervisor agency and area Sanitary Inspector (D3)	Each	1	5000.00	5000.00
17	Supplying and fixing sinage with fixing stand post for public toilet for visible to passersby.	Each	3	1000.00	3000.00
18	Supplying roaster / register for keeping account of regular cleaning	Each	3	200.00	600.00
19	Lettering on toilet wall for display of name and contact details of ULB, Ward number and name of maintainance authority, sanitary inspector, etc. (D3)	Each	1	1000.00	1000.00
20	SMS/any other ICT based feedback system (with number displayed on which SMS has to be sent) (A9)	Each	1	5000.00	5000.00
21	Mini tulu pump	Each	1	4000.00	4000.00
22	Sinage ACP Base & reflective Vinyl	Each	2	3776.00	7552.00
23	Installation of Sinage	Each	2	2071.00	4142.00
				<b>Total</b>	<b>Rs. 44552.00</b>
				Add 1% Cess (Rs.)	445.52
				<b>Total (Rs.)</b>	<b>44997.52</b>
				Add 3% Contingency (Rs.)	1349.93
				<b>Grand Total (Rs.)</b>	<b>46347.45</b>
				<b>Say Rs.</b>	<b>46347.00</b>

*[Signature]*  
 Junior Engineer  
 Malda Division  
 M. E. Directorate  
 Govt. of West Bengal

*[Signature]*  
 Assistant Engineer  
 Malda Division  
 M.E. Directorate  
 Dept. Of UD & MA  
 Govt. Of West Bengal

*[Signature]*  
 Anwarab P. Das  
 S. A. E. (C)  
 English Bazar Municipality  
 MALDA

*[Signature]*  
 Executive Engineer  
 Malda Division  
 M.E. Directorate  
 Deptt. Of UD & MA  
 Govt. Of West Bengal

*[Signature]*  
 Chairman  
 English Bazar Municipality  
 MALDA

1336.56  
 46334.00  
 46334.00

**- Estimate for Electrical Work of 5 Seated Institutional Toilet block at Barlow Girls' High School (H.S) in Ward No. - 08 Under Englishbazar Municipality of West Bengal (MODEL NO - A)**

**[ASPIRATIONAL PARAMETER]**

**PWD & I & WD schedule district charges will be applicable on PWD & I & WD schedule items**

**district charges will be applicable on non-schedule items**

No.	Item Description	Unit	Quantity	Rate	Amount
1	Distribution wiring in 2 x 22/0.3 (1.5 sqmm) single core stranded 'FR' PVC insulated & unsheathed copper wire (Brand approved by EIC) in 20mm size PVC rigid conduit 'FR' ( <b>Precision make</b> ), with 1x22/0.3 (1.5 sqmm) single core stranded 'FR' PVC insulated & unsheathed copper wire for ECC, to light/fan/call bell points with Piano Key type switchfixed on MS CRC sheet metal (16 SWG) switch board cum JB on wall complete with 2 no. suitable size "Ph & N" copper bar incl. bakelite/Perspex (wall matching color) top cover 3 mm thick and incl. 175mmx100mmx65mm inspection box, making earthing attachment, painting the MS box and mending good the damages to original finish. <b>[PWD Schedule Page No-E-14 Item No-2a]</b>	Point	19	642.60	12209.40
	Average run 5 mtr				
2	Distribution wiring in 1.1 KV grade 22/0.3 (1.5 sqmm) single core stranded 'FR' PVC insulated & unsheathed copper wire (Brand approved by EIC) in 20mm size PVC rigid conduit 'FR' ( <b>Precision make</b> ), with 1.1 KV grade 1 x 22/0.3 (1.5 sqmm) single core stranded 'FR' PVC insulated & unsheathed copper wire as ECC, to 5A 3 pin flush type plug socket & Piano Key type switch fixed on MS CRC sheet metal (16 SWG) switch board cum JB on wall incl. bakelite/Perspex (wall matching color) top cover 3 mm thick and incl. painting the MS box and mending good the damages to original finish <b>On Board (only for pay counter)</b> <b>[PWD Schedule Page No-E-15; I-4a]</b>	Point	2	70.35	140.70 <del>70.35</del>
3	Supplying and fixing 240V 32A Double Pole AC Type 30mA RCCB.(Complete Set) (ISI marked) [ <b>Make- Legrand</b> ] (Cat No 4113/95) <b>[ Legrand Page No-92 ]</b>	Nos	1	5942.00	5942.00
4	Distribution wiring in 1.1 KV single core stranded 'FR' PVC insulated & unsheathed copper wire (Brand approved by EIC) in 20mm size PVC rigid conduit 'FR' ( <b>Precision make</b> ) incl. necy. fittings as required 2 x 36/0.3 (2.5 sqmm) + 1 x 22/0.3 (1.5 sqmm) ECC <b>[PWD Schedule Page No-E-14 Item No-1a(ii)]</b>	mtr	20	124.95	2499.00
5	Supplying and fixing double-door SPN MCB Distribution Board with IP-42/43 protection, concealed in wall after cutting the wall & mending good the damages to original finish incl. Inter connection with suitable size of copper wire and neutral link & provision for earthing attachment. <b>a) For (2+4 way) (Make -Havells)</b> <b>[PWD Schedule Page No-D-9;Item No-13]</b>	No	1	981.75	981.75
6	Supplying and fixing 240/415 V MCB of Breaking capacity 10kA & C characteristics on din rail of existing DBs and necessary connection 6-32A SP MCB ( <b>Make -Havells</b> ) <b>[PWD Schedule Page No-D-6;Item No-7]</b>	Nos	4	176.40	705.60
7	Supplying and fixing 240/415 V MCB Isolator on din rail of existing DBs and necessary connection. 40A DP MCB Isolator ( <b>Make -Havells</b> ) <b>[PWD Schedule Page No-D-5;Item No-6]</b>	Nos	1	218.40	218.40
8	Supply of TMC501 conventional industrial batten ( <b>Philips make</b> ) LED Tube,model no- TMC501 P1xT-LED 22W P3241 <b>(WB I &amp; WD schedule P-113, I- 5:3 F.22)</b>	Nos	4	464.53	1858.12
9	Fixing only single/twin fluroscent light fitting complete with all accessories directly on wall/ceiling by screws etc.. <b>[PWD Schedule Page No-C-2;Item No-14a]</b>	Nos	4	90.30	361.20
10	Supply & fixing Bulk head light fittings with die cast aluminium housing frosted/clear glass on wall/ceiling incl S/F 9 watt LED Lamp complete set. [ <b>Make - Havells</b> ] <b>(PWD sch - Page--D-13, I-23)</b>	Nos	6	682.95	4097.70

	Supplying smart bright street light complete with all accessories to be fixed on wall of building or on pole incl. making holes /providing clamping material & necy. GI reducer as required.S&F 40 mm GI Pipe 1.5 mtr average length & s&f necy length of 1.5 sqmm pvc insulated single core copper wire & making connections as required & mending good damages incl wall painting. <b>(30 Watt) (Make - Bajaj)</b> <b>[WB I&amp;WD sch P-111, I-f.9.0.2]</b>	Nos	1	3106.48	3106.48
12	Supply of 12" domestic metal exhaust fan 230V 50 Hz (Model- Trans Air 12" Grey) ( Make-Crompton/Havells/Bajaj) (UD & MA schedule P-14, I-5)	Nos	6	2093.00	12558.00
13	Fixing only exhaust fan after making hole in wall and making good damages and smooth cement finish etc. as practicable as possible and providing necy. length of PVC insulated wire and making connection for exhaust of following diameter: 30 cm (12") <b>[PWD Schedule Page No-C-4;Iteam No-28(b)]</b>	Nos	6	345.45	2072.70
14	Fixing only louver shutter/cowl on wall with necy. bolts & nuts (6 mm dia x 62 mm long) For 30 cm(12") Exhaust fan <b>Schedule Page No-C-4;Iteam No-28(b)</b>	Nos	6	115.50	693.00
15	Supply of 240V A.C Ceiling Fan ( 48" sweep,1200 mm complete) <b>[Make-Crompton [ for counter only]</b> <b>(UD &amp; MA schedule P- 23, I- 70)</b>	Each	1	2283.00	2283.00
16	Fixing only Ceiling Fan <b>[PWD sch P- C-3, I-21(a)]</b>	Each	1	69.30	69.30
17	Supply & Fixing 240 V, 16/20 A Piano key type switch (Brand approved by EIC) on sheet metal switch board incl. S & F 100x100x65mm MS (16SWG) switch board and bakelite/perspex top cover of 3mm thick by Brass screws after making housing for switch by cutting bakelite/perspex cover and making necessary connections as required. (For Hand Dryer machine) <b>[PWD sch P- E-6, I-17(b)]</b>	Each	2	211.05	422.10
18	S/F 240V 25A Modular type starter (brand approved by EIC)with 25 A. Modular switch DP MCB (C-Curve)and 4 Module G.I. Moduar type switch board with 4 Module Top Cover Plate flushed in wall incl. S/F switch board and Cover Plate and making necy. Connections with PVC Copper wire and earth connectivity wire etc. as per schedule <b>[for Pump]</b> <b>[PWD Schedule Page No-E-19, Item No-17]</b> <b>(Please follow in details)</b>	Nos	1	823.20	823.20
19	Supply and Fixing of 2 mm Polyvinyl glow sign board made of 22 SWG GI sheet box with 1"X1" aluminum channel for fixing the vinyl board after necessary cutting the letter as required & s/f LED tube light fittings along with all accessories. (16 sqft @495.00/sqft) <b>(UD &amp; MA schedule P-14, I-4)</b>	Nos	1	7920.00	7920.00
20	Earthing installation by GI earth Spike (1830 X 20 mm) including 8SWG GI EarthWire & GI nuts, bolts, washer etc.	Nos	1	450.00	450.00
				<b>Total</b>	<b>59341.30</b>
				Add 18% GST	10681.43
				<b>Total With GST (A)</b>	<b>70022.73</b>
				Cess@1%	700.23
				total	70722.96
				Contingency@3%	2100.68
				<b>Total</b>	<b>72823.64</b>
				<b>Say Rs.</b>	<b>72824</b>

59411.65  
10694.09  
70105.74  
701.05  
70806.79  
2103.17  
72909.96  
72910.00

Service Connection Charges as per Quotation

Say Rs. 72,910.00

Pranab R. Das  
S. A. E. (C)  
English Bazar Municipality  
MALDA

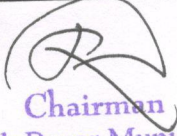
  
Chairman  
English Bazar Municipality  
MALDA

P.T.O

BF, RS. 72,910.00

Technically Vetted Rs. 72,910.00  
(Rupees Seventy two thousand Nine hundred  
Tem only.)

*00*  
Junior Engineer *09-04-25*  
Electrical & Mechanical Division  
SUDA

*Sd/-*  
*9.4.25*  
ASSISTANT ENGINEER  
ELECTRICAL & MECHANICAL DIVISION  
SUDA

*ds*  
*11/4/25*  
Executive Engineer (E/M)  
O/O the Secretary M.E. Dte.  
Government of West Bengal

22-11-25  
20-11-25  
18-11-25  
16-11-25  
14-11-25  
12-11-25  
10-11-25  
08-11-25  
06-11-25  
04-11-25  
02-11-25

22-11-25

*00*  
M.A.D.A.

MODLE DRAWING FOR CONSTRUCTION OF C. T./P.T.  
 Toilet Seats - 5 Nos Urinal 5 Nos  
 MODLE NO.- A

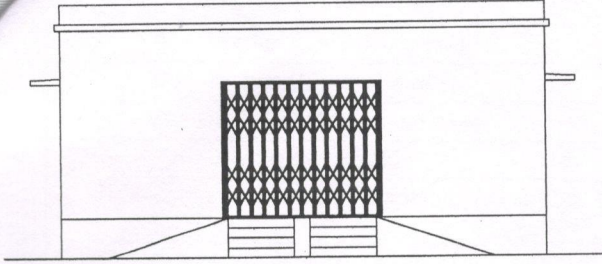

FRONT ELEVATION

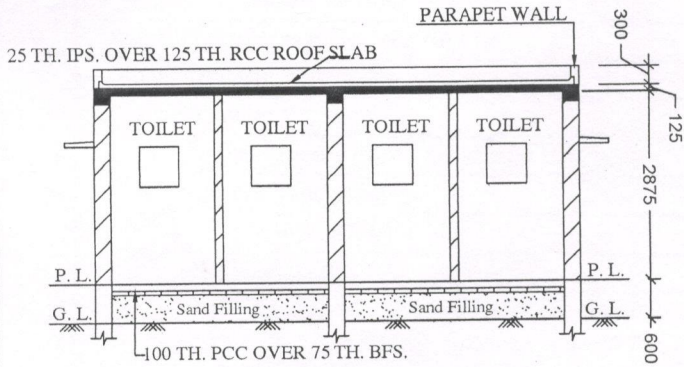

SECTION - 'A - A'

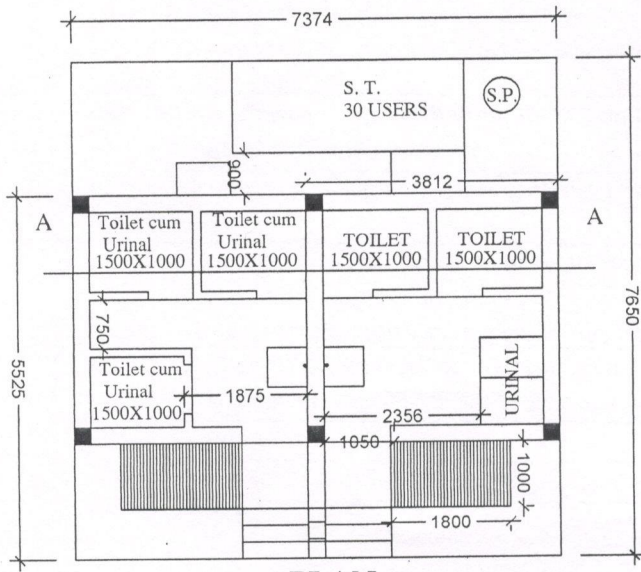

PLAN

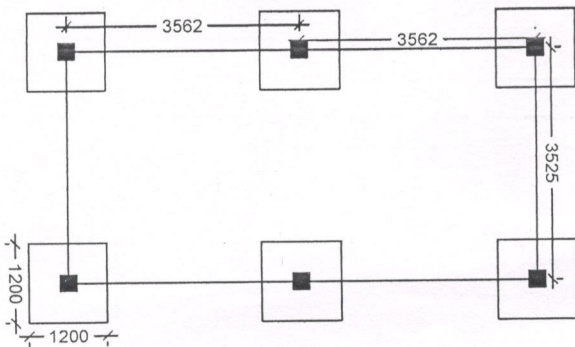

LAYOUT PLAN

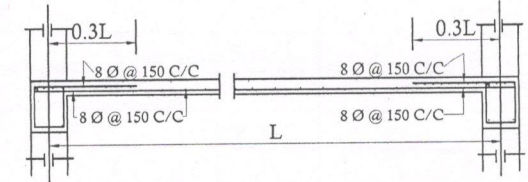
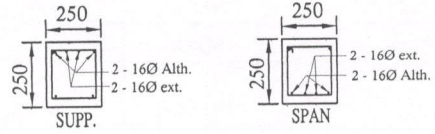

Details Of R.C.C Roof Slab & Beam

(SCALE - 1 : 25)

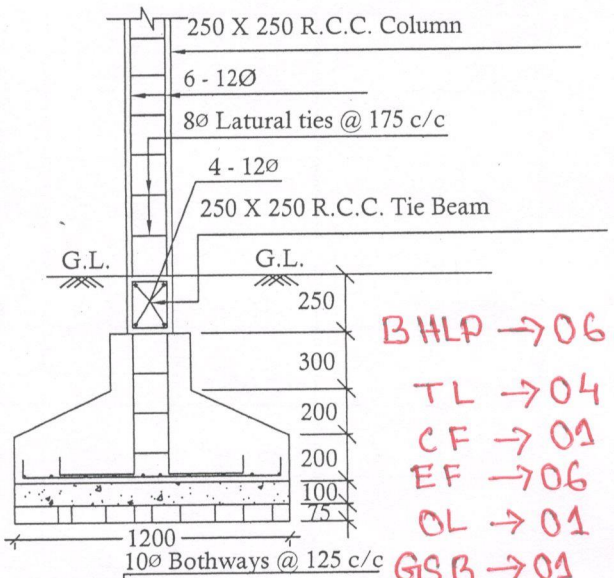

BHLP → 06  
 TL → 04  
 CF → 01  
 EF → 06  
 OL → 01  
 GSB → 01

19.13

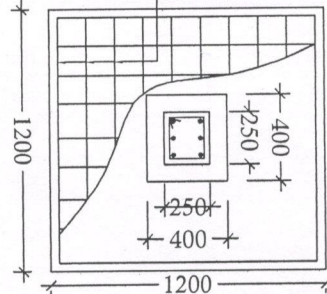

DETAILS OF R. C. C COLUMN

(SCALE - 1 : 25)

*Pranab R. Das*  
 S. A. E. (C)  
 English Bazar Municipality  
 MALDA

*(Signature)*  
 Chairman  
 English Bazar Municipality  
 MALDA