

**ESTIMATE FOR CONSTRUCTION OF TOILET BLOCK (PT) (MODEL NO-G) AT CHHAT GHAT IN WARD
NO:-02 UNDER DAINHAT MUNICIPALITY.
TOILET SEATS -4 NOS AND URINAL- 5 NOS**

SL.NO	Item Description & Item No.	Quantity	Rate	Unit	Amount
1	Earth work in excavation of foundation trenches or drains, in all sorts of soil (including mixed soil but excluding laterite or sandstone) including removing, spreading or stacking the spoils within a lead of 75 m. as directed. The item includes necessary trimming the sides of trenches, levelling, dressing and ramming the bottom, bailing out water as required complete. (a) Depth of excavation not exceeding 1,500 mm. PWD Building Works schedule Page - 1, Item -2.a COLM. 3 X 2 X 1.20 X 1.20 X 1.00 = 8.64 M3 partition wall 1x 1.00 x 0.375 x 0.150 = 0.056 m3	8.696	119.27	Cu.m	1037.17
2	Earth work in filling in foundation trenches or plinth with good earth, in layers not exceeding 150 mm. including watering and ramming etc. layer by layer complete. (Payment to be made on the basis of measurement of finished quantity of work). (a) With earth obtained from excavation of foundation. PWD Building Works schedule, Page - 1, Item -3.a	8.696	77.54	Cum	674.29
3	(A) Filling in foundation or plinth by silver sand in layers not exceeding 150 mm as directed and consolidating the same by thorough saturation with water, ramming complete including the cost of supply of sand. (payment to be made on measurement of finished quantity) PWD Building Works schedule, Page - 2,Item-4.a(5th corrigenda) 1 x 5.10 x 4.55 x 0.325 = 7.542 m3	7.542	640.86	Cum	4833.37
4	Single Brick Flat Soling of picked jhama bricks including ramming and dressing bed to proper level and filling joints with local sand. PWD Building Works schedule, Page- 14, Item - 1 (3rd corrigenda Date-04-06-2018) 3 x 2 x 1.20 x 1.20 = 8.64 m2 2 x 2.50 x 0.375 = 1.88 m2 1 x 1.00 x 0.375 = 0.375 m2 2 x 1.50 x 1.00 = 3.00 m2 1 x 5.10 x 4.55 = 23.21 m2	37.10	324.00	Sqm	12020.40
5	Ordinary Cement concrete (mix 1:1.5:3) with graded stone chips (20 mm nominal size) excluding shuttering and reinforcement, if any, in ground floor as per relevant IS codes. a) Pakur Variety /Chandil Variety PWD Building Works schedule, p-26 Item 10 a (Rate Analysis) 2 x 3 x 1.20 x 1.20 x 0.150 = 1.296 m3 2 x 3 x (1.20 x 1.20) + (0.250 x 0.250) /2 x 0.150 = 0.676 m3 2 x 3 x 0.250 x 0.250 x 3.90 = 1.463 m3 2 x 2 x 2.525 x 0.250 x 0.250 = 0.789 m3 3 x 3.00 x 0.250 x 0.250 = 0.563 m3 2 x 2 x 2.525 x 0.250 x 0.150 = 0.379 m3 3 x 3.00 x 0.250 x 0.150 = 0.338 m3 1 x 5.10 x 4.55 x 0.1025 = 2.900 m3	8.38	5607.73	Cum	46975.95

SL.NO	Item Description & Item No.	Quantity	Rate	Unit	Amount
6	Cement concrete with graded jhama khoa (30 mm size) excluding shuttering in ground floor and foundation. (a) 1:3:6 proportion. PWD Building Works schedule, Page -23, Item -B.1.a, (Corri. Page- 09, Date-04-06-2018) Rate Analysis1 (Corri. Page-01, Date-04-06-2018) 37.10 X 0.100 = 3.71 M3	3.710	4830.00	m3	17919.30
7	25mm. thick damp proof course with cement concrete with stone chips (1:1.5:3) [with graded stone aggregate 10 mm nominal size] and admixture of water proofing compound as per manufacturer's specification followed by two coat of polymer based paint, (1st coat after 4 to 5 days of concrete laying and 2 nd coat just before brick masonry work) as directed (cost of water proofing compound & polymer based paint to be paid separately).(Chequering not required over concrete or painted surface). [Note: -Waterproofing as per item 9,polymer based paint as per item8 (a) of subhead C of Section (C). PWD Building Works schedule, Page -47, Item -1 (Rate Analysis) 2 x 5.10 x 0.250 = 2.55 m2 3 x 4.55 x 0.250 = 3.41 m2	5.96	178.00 176.00	Sqm	1048.96 1060.88
8	125 mm brick work with 1st classbricks in cement mortar (1:4) in ground floor. PWD Building Works schedule, Page -16, Item-16,cori page -3, date -04.06.2018 (Rate Analysis) 5 x 1.20 x 3.00 = 18.00 m2 3x1.00 x 3.00 = 9.00 m2	27.00	664.00	Sq.M.	17928.00
9	Supplying and laying polythine sheet (150 gm/sq.m) over dampproof course or below flooring or roof terracing or foundation or foundation trenches. PWD Building Works schedule, Page -47, Item-3	23.21	24.00	Sq.M.	557.04
10	Hire and labour charges for shuttering with centering and necessary staging upto 4 m using approved stout props and thick hard wood planks of approved thickness with required bracing for concrete slabs, beams and columns, lintels curved or straight including fitting, fixing and striking out after completion of works (upto roof of ground floor) (f) 25 mm to 30 mm shuttering without staging in foundation PWD Building Works schedule, Page -42, Item- 36.f 2 x 2 x 5.10 x 0.250 = 5.10 m2 3x 2 x 4.55 x 0.25 = 6.83 m2 6 x 4 x 1.20 x 0.150 = 4.32 m2	16.25	205.00	Sqm	3331.25

SL.NO	Item Description & Item No.	Quantity	Rate	Unit	Amount
11	<p>Hire and labour charges for shuttering with centering and necessary staging upto 4 m using approved stout props and thick hard wood planks of approved thickness with required bracing for concrete slabs, beams and columns, lintels curved or straight including fitting, fixing and striking out after completion of works (upto roof of ground floor)</p> <p>(a) 25 mm to 30 mm thick wooden shuttering as per decision & direction of Engineer-In-Charge.</p> <p>PWD Building Works schedule, Page -42, Item- 36.a</p> <p>$1 \times 5.10 \times 4.55 = 23.21 \text{ m}^2$</p> <p>$2(5.10 + 4.55) \times 0.125 = 2.41 \text{ m}^2$</p> <p>$6(.30+.025) \times 3.00 = 9.90 \text{ m}^2$</p> <p>$2 \times 2 \times 5.1 \times 0.1250 = 3.825 \text{ m}^2$</p> <p>$3 \times 2 \times 4.55 \times 0.125 = 3.41 \text{ m}^2$</p>	42.75	328.00	Sqm	14022.00
12	<p>Artificial stone in floor ,dado,staircaseetc with cement mortar (1:2:4)with stone chips lsied in panels as directed with topping made with ordinary or white cement (as necessary) and marbel dust in proportion (1:2) in cluding smooth finishing and rounding off corners including raking out joints or roughening of concrete surface and application of cement slurry before flooring works using cement @ 1.75 kg/ sq.m all complete including all materials and labour.</p> <p>In ground floor</p> <p>3 mm thick topping using gray cement (ii)25 mm</p> <p>PWD Building Works schedule, p-48 Item 6(ii)</p> <p>$5.10 \times 4.55 = 23.21 \text{ m}^2$</p>	23.21	263.00 264.00	Sq.m	6104.23 6127.44
13	<p>Reinforcement for reinforced concrete work in all sorts of structures including distribution bars, stirrups, binders etc initial straightening and removal of loose rust (if necessary), cutting to requisite length, hooking and bending to correct shape, placing in proper position and binding with 16 gauge black annealed wire at every intersection, complete as per drawing and direction. (a) For works in foundation and upto roof of ground floor/upto 4 m.</p> <p>(i) Tor steel/Mild Steel , JSPL/SWAYN/ELETRO/STEEL</p> <p>PWD Building Works schedule, Page - 43, Item - 40.a.i.1(Corri. 10th Page-01, Date-23-01-2020) (Rate Analysis)</p> <p>Item no , vol of conc. $8.38 \times 1.20 \% = 0.1005 \text{ m}^3 \times 35.315 \text{ c.ft} = 3.549 \text{ c.ft} \times 225 \text{ kg} = 798.52 \text{ kg} = 0.799 \text{ MT}$</p>	0.799	54375.54	M.T.	43446.06
14	<p>Collapsible gate with 40 mm x 10 mm x 6 mm Tee as top and bottom guide rail , 20 mm x 10 mm x 2 mm vertical channels 100 mm apart in fullt stretched position 20m x 5 mm MS flats as collapsible bracings properly reveted and washered including 38 mm steel roller including locking arrangements , fitted and fixed in position with lugs set in cement concrete including cutting necessary hikes chasing etc in walls , floors etc and making good all damages .</p> <p>PWD Building Works schedule, Page -106, Item- .18</p> <p>$2 \times 1.00 \times 2.10 = 4.20 \text{ m}^2$</p>	4.20	3402.00 4330.00	Sqm	14288.40 18186.00

SL.NO	Item Description & Item No.	Quantity	Rate	Unit	Amount
15	Brick work with 1st class bricks in cement mortar (1:4) (a) Foundation and plinth ground floor PWD Building Works schedule, Page -15, Item-7.a (Rate Analysis) $2 \times 5.10 \times 0.250 \times 0.600 = 1.53 \text{ m}^3$ $3 \times 4.550 \times 0.250 \times 0.600 = 2.048 \text{ m}^3$ $2 \times 2.50 \times 0.250 \times 0.600 = 0.750 \text{ M}^3$ $2 \times 1.00 \times 0.500 \times 0.300 = 0.300 \text{ M}^3$	4.628	5081.00	Cu.m	23514.87
16	Brick work with 1st class bricks in cement mortar (1:4) (b) superstructure ground floor PWD Building Works schedule, Page -15, Item-7.b (Rate Analysis) $2 \times 5.10 \times 0.250 \times 3.00 = 7.65 \text{ m}^3$ $3 \times 4.55 \times 0.250 \times 3.00 = 10.238 \text{ m}^3$	17.89	5304.00	Cu.m	94888.56
17	Labour for Chipping of concrete surface before taking up Plastering work. PWD Building Works schedule, P-192, It-1	23.21	21.00	Sqm	487.41
18	Plaster (to wall, floor, ceiling etc.) with sand and cement mortar including rounding off or chamfering corners as directed and raking out joints including throating, nosing and drip course, scaffolding/staging where necessary (Ground floor).[Excluding cost of chipping over concrete surface] (i) With 1:6 cement mortar (c) 15 mm thick plaster PWD Building Works schedule, P-189 It- No. 1 (Rate Analysis) $2(5.1 + 4.55) \times 3.75 = 72.388 \text{ m}^2$ $2(5.10 + 4.55) \times 3.00 = 57.90 \text{ m}^2$ $3 \times 2 \times 1.00 \times 3.00 = 18.00 \text{ m}^2$ $5 \times 2 \times 1.20 \times 3.00 = 36.00 \text{ m}^2$	184.29	136.00	Sqm	25063.44
19	Plaster (to wall, floor, ceiling etc.) with sand and cement mortar including rounding off or chamfering corners as directed and raking out joints including throating, nosing and drip course, scaffolding/staging where necessary (Ground floor).[Excluding cost of chipping over concrete surface] (ii) With 1:4 cement mortar (c) 10 mm thick plaster PWD Building Works schedule, P-189 It- No. 1 (ii)(c) (Rate Analysis) $5.1 \times 4.55 = 23.21 \text{ m}^2$	23.21	123.00	Sqm	2854.83
20	Neat cement punning about 1.5 mm thick in wall ,dado, window sills, floors etc . Note cement 0.152 m3/100 m2 PWD Building Works schedule, P-192 It- No. 15 $2(5.10 + 4.55) \times 0.75 = 14.48 \text{ m}^2$	14.48	34.00	Sq.m	492.32

SL.NO	Item Description & Item No.	Quantity	Rate	Unit	Amount
21	Supplying, fitting and fixing fibre reinforced polymer (FRP) Composite door frame as per approved section with glass fibre reinforced plastic moulded skins and a special sandwich core, so as to impart monolithic composite structure as per approved technology of Department of Science and Technology (DST) to satisfy IS: 4020 door testing performance criteria. (i) 66mm x 90mm PWD Building Works schedule, P-115, It - 3 (i) $4 (2 \times 2.10 + 0.75) = 19.80 \text{ M}$	19.80	497.00	Mtr	9840.60
22	Supplying, fitting & fixing fibre reinforced polymer (FRP) Composite door shutters as per approved design with glass fibre reinforced plastic moulded skins and a special sandwich core, so as to impart monolithic composite structure as per approved technology of Department of Science and Technology (DST) to satisfy IS:4020 door testing performance criteria. In ground floor. ii) 25 mm thick P-125, It- 14(ii) $4 \times 2.10 \times 0.75 = 6.30 \text{ m}^2$	6.30	2581.00	Sqm	16260.30
23	Anodised aluminium barrel / tower / socket bolt (full covered) of approved manufactured from extruded section conforming to I.S. 204/74 fitted and fixed with cadmium plated screws . (vii) 225mm long x 10mm dia. bolt. PWD Building Works schedule, P-144, It No. 26 (vii)	5.00	84.00	Each	420.00
24	Iron butt hinges of approved quality fitted and fixed with steel screws, with ISI mark. (viii) 100mm X 75mm X 3.50mm. PWD Building Works schedule, P-140, It No. -5 (viii)	15.00	66.00	Each	990.00
25	Anodised aluminium decorative handle (hexagonal / fluted) of approved quality fitted and fixed complete. (i) 150mm plate x 10mm dia rod x 12mm hexagonal/fluted. PWD Building Works schedule, Page -146 . Item no-31,(i)	10.00	87.00	Each	870.00
26	Iron hasp bolt of approved quality fitted and fixed complete (oxidised) with 16mm dia rod with concrete bolt and round fitting..b)250mm long. PWD Building Works schedule, Page -141 . Item no-10 b)	5.00	159.00	Each	795.00
27	Supplying and laying chequered tiles of any shade and of approved quality with (1:1.5:3) cement concrete laied in pannels or patterns as directed in pavement ,footpath etc including necessary underlay 25 mm thick (avg)cement mortar (1:3) complete in all respect with all labour and materials. (Using cement slurry @4.4kg/sq.m at back side and @2.4 kg/sq.m for joint filling). PWD Building Works schedule, Page -74 , Item no- 46(i). 25 mm thick $2 \times 2.00 \times 1.00 = 4.00 \text{ m}^2$	4.00	455.00	sq.m	1820.00

L.NO	Item Description & Item No.	Quantity	Rate	Unit	Amount
28	Rendering the Surface of walls and ceiling with White Cement base WATER PROOF wall putty of approved make & brand.(1.5 mm thick) In Ground Floor PWD Building Works schedule, PWD, P- 198, I - 5 $184.26 + 23.21 = 207.50 \text{ m}^2$	207.50	122.00	Sqm	25315.00
29	Applying interior grade Acrylic Primer of approved quality and brand on plastered and concrete surface old or new surface to receive Distemper Acrylic emulsion paint including scraping and preparing the surface thoroughly , complete as per manufacturer's specification and as per direction of the E-I-C (Ground Floor) (b) Two Coats PWD Building Works schedule, Page -74 , Item no- 46(i). $57.90 + 28.00 + 36.00 + 23.21 - 82.43 = 52.68 \text{ m}^2$	62.68	44.20	m2	2770.46
30	Dry Destempering interial walls or ceiling including cleaning, washing, smoothening surface (b) two coats PWD Building Works schedule, Page -196 , Item no- 9(b) .	62.68	49.00	m2	3071.32
31	Applying exterior grade Acrylic Primer of approved quality and brand on plastered or concrete surface old or new surface to receive Decorative Textured (Marth Finish) or Smooth Finish Acrylic exterior emulsion paint including scraping and preparing the surface thoroughly , complete as per manufacturer's specification and as per direction of the EIC in Ground Floor (b) two coats. PWD Building Works schedule, Page -196 , Item no- 8(b)	72.39	45.10	m2	3264.79
32	Protective and Decorative Acrylic Exterior emulsion paint of approved quality, as per manufacturer's specification and as per direction of EIC to be applied overf Acrylic primer as required. The rate includes cost of materials, labour, scaffolding and all incidental charges but excluding the cost of primer in ground floor (two coats)(a) normal acrylic emulsion. PWD Building Works schedule, Page -197 , Item no- 17(a)	72.39	67.00	m2	4850.13
33	(b) Priming one coat on timber or plastered surface with synthetic oil bound primer of approved quality including smoothening surfaces by sand papering etc. PWD Building Works schedule, Page -200 . Item no- 1 (b)	6.35	38.00	Sqm	241.30
34	(A) Painting with best quality synthetic enamel paint of approved make and brand including smoothening surface by sand papering etc. including using of approved putty etc. on the surface, if necessary : Page - 200 . Item no- 1 (b) (a) On timber or plastered surface : With super gloss (hi-gloss) - (iv) Two coats (with any shade except white) PWD Building Works schedule, Page -200 . Item no- 2(A)(a)(iv)	6.35	81.00	Sqm	514.35

SL.NO	Item Description & Item No.	Quantity	Rate	Unit	Ammount
35	(a) M.S.or W.I. Ornamental grill of approved design joints continuously welded with M.S, W.I. Flats and bars of windows, railing etc. fitted and fixed with necessary screws and lugs in ground floor. (i)Grill weighing above 10 Kg./sq.mtr and up to 16 Kg./sq. mtr. PWD Building Works schedule, P-104 Item-13 A (i) (3rd Corrigendam Page No 91) $2 \times 2.00 \times 0.750 = 3.00 \text{ m}^2$ $6 \times 0.600 \times 0.600 = 2.16 \text{ m}^2$ $= 5.16 \text{ m}^2 \times 10.00 \text{ kg} = 51.60 \text{ kg} = 0.516 \text{ qtl}$	0.516	9888.00	Qntl	5102.21
36	a) Priming one coat on steel or other metal surface with synthetic oil bound primer of approved quality including smoothening surfaces by sand papering etc. PWD Building Works schedule, P/200 Item-1(a)	5.16	29.00	Sqm	149.64
37	(A) Painting with best quality synthetic enamel paint of approved make and brand including smoothening surface by sand papering etc. including using of approved putty etc. on the surface, if necessary : (b) On steel or other metal surface : (iv) Two coats (with any shade except white) PWD Building Works schedule, P-200 Item-2(b)(iv)	5.16	79.00	Sqm	407.64
38	Supplying and laying true to line and level vitrified tiles of approved brand (size not less than 600 mm X 600 mm X 10 mm thick) in floor, skirting etc. set in 20 mm sand cement mortar (1:4) and 2 mm thick cement slurry back side of tiles using cement @ 2.91Kg./sqM or using polymerised adhesive (6 mm thick layer applied directly over finished artificial stone floor/Mosaic etc without any backing course) laid after application slurry using 1.75 Kg of cement per sqM below mortar only, joints grouted with admixture of white cement and colouring Pigment to match with colour of tiles / epoxy grout materials of approved make as directed and removal of wax coating of top surface of tiles with warm water and polishing the tiles using soft and dry cloth upto mirror finish complete including the cost of materials, labour and all other incidental charges complete true to the manufacturer's specification and direction of Engineer-in-Charge. (White cement, synthetic adhesive and grout material to be supplied by the contr[e]) I (I) With application slurry @1.75 kg/ Sq.m, 20 mm sand cement mortar (1:4) & 2 mm thick cement slurry at back side of tiles, 0.2 kg/ Sq.m white cement for joint filling with pigment. (A) Deep Colour & White PWD Building Works schedule, Page-66 Item-36 (A) (3rd Floor $5.10 \times 4.55 = 23.21 \text{ m}^2$	23.21	1682.00 1263.00	Sqm	39039.22 29314.23

SL.NO	Item Description & Item No.	Quantity	Rate	Unit	Amount
39	<p>Supplying, fitting & fixing 1st quality Ceramic tiles in walls and floors to match with the existing work & 4 nos. of key stones (10mm) fixed with araldite at the back of each tile & finishing the joints with white cement mixed with colouring oxide if required to match the colour of tiles including roughening of concrete surface, if necessary or by synthetic adhesive & grout materials etc.</p> <p>B) Wall Area of each tile above 0.09 Sq.m</p> <p>ii) Other than Coloured decorative including white PWD Building Works schedule, page-64, Item:35.(B.) (b).(ii) (3rd Corrigendum ,Page 36) 2(7.375 + 3.250) x 2.10 = 44.63 m² 3x2 x 1.00 x 2.10 = 12.60 m² 5 x 2 x 1.20 x 2.10 = 25.20 m²</p>	82.43	1031.00	Sq.m	84985.33
40	<p>Supplying profiles of required section made of Aluminium Alloy Extrusions conforming to IS: 732-1983 and IS: 1285- 1975; Anodized (with required film thickness and specified colour / natural) matt finished conforming to IS: 1868-1983 for fabrication of composit door, sliding & casement windows, partitions, formed of basic sections of any ISI embossed / certified make and brand as per direction of Engineer - In- Charge. (Payment will be made on finished length of the work).</p> <p>(A) In 10-12 Micron thickness Anodizing film l) Natural white h) Louvered window. i) Top, bottom and side member. PWD Building Works schedule, PWD, P-233, I- 1(h) i</p>	8.40	183.00	M	1537.20
41	ii) Louvered Section.	7.20	658.00	M	4737.60
42	iii) Cleat angle (Non-anodized).	6.48	263.00	M	1704.24
43	<p>Supplying bubble free float glass of approved make and brand conforming to IS: 2835-1987.</p> <p>iv) 5mm thick coloured / tinted / smoke glass. PWD Building Works schedule, P-243, I-9</p>	1.08	585.00	Sq.M.	631.80
44	<p>Painting block letters or digits in Black Japan or any approved paint as per direction.</p> <p>e) Size above 7.5 cm. and upto 10 cm. PWD Building Works schedule, P-268, It-17(e)</p>	450.00	12.00	Each	5400.00
45	<p>Supplying and planting of different plants / trees (supplying well grown plants bushy and healthy, minimum height as specified i.e. exposed height including all leads and lifts, carriage, handling, manuring applying pesticide and fertilizer etc.</p> <p>i) Furcaria Veriegated 10 to 12 leaves in height 20-30 cm in</p>	10.00	162.00	Each	1620.00
46	<p>x) Ficus blakii (F. Vivicon) well branched (Bushy) of height 120cm - 135 cm in earthen pot of size 30cm. PWD Building Works schedule, Page -261, It- 9 (x)</p>	3.00	187.00	Each	561.00

SL.NO	Item Description & Item No.	Quantity	Rate	Unit	Amount
47	xxvi) Areca Palm 4 - 5 suckers of height 90 cm to 105 cm in earthen pots of size 25 cm. PWD Building Works schedule, Page -261, It- 9 (xxvi)	3.00	127.00	Each	381.00
SANITARY AND PLUMBING WORKS					
48	Supplying, fitting and fixing Anglo-Indian W.C. in white glazed vitreous china ware of approved make complete in position with necessary bolts, nuts etc. a) With 'P' trap (with vent) PWD S&P Schedule, page-79, item no -3 (a)	4.00	3104.00	Each	12416.00
49	Supplying, fitting and fixing Closet seat of approved make with lid and C.P. hinges, rubber buffer and brass screws complete .(b) Anglo Indian (i) Plastic (hallow type) White PWD S&P Schedule, page-81,item no 10.b.i	4.00	380.00	Each	1520.00
50	Supplying, fitting and fixing Flat back urinal (half stall urinal) in white vitreous chinaware of approved make in position with brass screws on 75 mm X 75 mm X 75 mm wooden blocks complete (ii) 470 mm X 280 mm X 340 mm PWD S&P Schedule, page.80,item no-6/(ii)	3.00	945.00	Each	2835.00
51	Supplying fitting and fixing squatting plate with integrated flushing in white vitreous set in cement concrete (6:3:1) with jhama chips complete. (Payment of concrete will be paid seperately) (I) 450 mm x 350 mm	2.00	881.00	each	1762.00
52	Supplying, fitting and fixing 10 litre P.V.C. low-down cistern conforming to I.S. specification with P.V.C. fittings complete,C.I. brackets including two coats of painting to bracket etc. PWD S&P Schedule, Page No.-36 Item No.-2,	4.00	1015.00	Nos	4060.00
53	Supplying, fitting and fixing 32 mm dia. Flush Pipe of approved make with necessary fixing materials and clamps complete. i) Polythene Flush Pipe PWD S&P Schedule, Page no 81. Item no. 11(i)	4.00	155.00	Each	620.00
54	Supplying, fitting and fixing urinal flush pipe fittings of approved brand. (a) C.P. urinal flush pipe fittings range of one PWD S&P Schedule, S.P.81,item-12/a	2.00	414.00	Each	828.00
55	Supplying, fitting and fixing white vitreous china best quality approved make wash basin with C.I. brackets on 75 mm X 75 mm wooden blocks, C.P. waste fittings of 32 mm dia., mending good all damages and painting the brackets with two coats of approved paint. (ii) 550 mm X 400 mm size PWD S&P Schedule, P-41, It 2 (ii)	2.00	2208.00	Each	4416.00
56	Supplying fitting and fixing pedestal of approved make for wash basin (White) PWD S&P Schedule, P-41, It 3	2.00	1497.00	Each	2994.00

SL.NO	Item Description & Item No.	Quantity	Rate	Unit	Amount
57	Supplying, fitting and fixing approved brand P.V.C. CONNECTOR white flexible, with both ends coupling with heavy brass C.P. nut, 15 mm dia., (iii) 600 mm long PWD S&P Schedule, Page No.-43 Item No.-9-iii	5.00	107.00	Each	535.00
58	Supplying, fitting and fixing approved brand 32 mm dia.P.V.C. waste pipe, with PVC coupling at one end fitted with necessary clamps. (iv) 1050 mm long each PWD S&P Schedule, Page No.-43 Item No. 10-iv	2.00	91.00	Each	182.00
59	(f) Hand Shower(Health Faucet) with 1mtr Flexible Tube with Wall Hook(Equivalent to Code No.573 & Model -ALLIED of Jaquar or similar). PWD S&P Schedule, Page No.-3 Item No.- 3 f,	5.00	1251.00	Each	6255.00
60	(a) (i) Chromium plated Bib Cock short body (Equivalent to Code No. 511 & Model - Tropical / Sumthing Special of ESSCO or similar brand). PWD S&P Schedule, Page No.-6 Item No.-7-a-i	7.00	539.00	Each	3773.00
61	(b) (i) Chromium plated Stop Cock (Equivalent to Code No. 513(A) & 513(B) & Model - Tropical / Sumthing Special of ESSCO or similar PWD S&P Schedule, Page No.-6 Item No.-7-b-i	5.00	493.00	Each	2465.00
62	Chromium plated angular Stop Cock with wall flange (Equivalent to Code No. 5053 & Model - Florentine of Jaquar or similar brand). PWD S&P Schedule, Page No.-6 Item No.-7-d-i,	5.00	815.00	Each	4075.00
63	Supplying, fitting and fixing pillar cock of approved make. a) (i) CP Pillar Cock - 15 mm. (Equivalent to Code No. 507 & Model - Tropical / Sumthing Special of ESSCO or similar brand). (P. No. - 45, Item. No. - 19(a)i, Pwd Sanitary Plumbing Schedule 2017)	2.00	555.00	Each	1110.00
64	Supplying, fitting and fixing PVC pipes of approved make of Schedule 80 (medium duty) conforming to ASTM D - 1785 and threaded to match with GI Pipes as per IS : 1239 (Part - I). with all necessary accessories, specials viz. socket, bend, tee, union, cross, elbo, nipple, longscrew, reducing socket, reducing tee, short piece etc. fitted with holder bats clamps, including cutting pipes, making threads, fitting, fixing etc. complete in all respect including cost of all necessary fittings as required, jointing materials and two coats of painting with approved paint in any position above ground. (Payment will be made on the centre line measurements of total pipe line including all specials. No separate payment will be made for accessories, specials. Payment for painting will be made seperately) (a) For Exposed Work PVC Pipes, 25 mm Page No.-12 Item No.-19-i(a), PWD, VOL-II , 2017-18	25.00	177.00	Mtr	4425.00

SL.NO	Item Description & Item No.	Quantity	Rate	Unit	Amount
65	(a) (a) For Exposed Work PVC Pipes, 15 mm Page No.-12 Item No.-19-i(a), PWD,VOL-II, 2017-18	10.00	101.00	Mtr	1010.00
66	(b) For Concealed Work PVC Pipes, 15 mm Page No.-12 Item No.-19-i(b), PWD,VOL-II, 2017-18	10.00	137.00	Mtr	1370.00
67	Supplying and fitting fixing of gunmetal wheel valve of approved brand and make tested to 21 Kg per sq. cm. 25 mm dia(E5) PWD S&P Schedule, P-5 It-5,vii),	2.00	778.00	Each	1556.00
68	Supplying P.V.C. water storage tank of approved quality with closed top with lid (Black) - Multilayer (b) 1000 litre capacity PWD S&P Schedule, page.37,item no-6 (b)	2.00	5128.00	Each	10256.00
69	Labour for hoisting plastic water storage tank. (i) Upto 1500 litre capacity. (a) Upto 1st story from G.L. PWD S&P Schedule, page.37,item no-10 (i)(a)	2.00	96.00	Each	192.00
70	Labour for punching hole in plastic water storage tank upto 50 mm dia. PWD S&P Schedule, (P. No. - 38, Item. No. - 13	4.00	19.00	Each	76.00
71	Supply of UPVC pipes (B Type) & fittings conforming to IS-13592- 1992.(A) (i) Single Socketed 3 Meter Length, (b) 110 mm PWD S&P Schedule, Page No.-68 Item No. 23,(A)(i)(b)	30.00	292.00	Mtr	8760.00
72	(B) Fittings (i) Coupler, (b) 110 mm	8.00	85.00	Each	680.00
73	(ii) Plain Tee, (b) 110 mm	12.00	85.00	Each	1020.00
74	(iii) Door Tee, (b) 110 mm	10.00	195.00	Each	1950.00
75	ix) Bend 45°, (b) 110 mm	10.00	89.00	Each	890.00
76	xi) Door Bend (T.S.), (b) 110 mm	7.00	147.00	Each	1029.00
77	xvi) Pipe Clip, (b) 110 mm	30.00	21.00	Each	630.00
78	xvii) W.C. Connector (150 mm long) 125 X 110(W/WC Ring) 75 mm	4.00	142.00	Each	568.00
79	xxxix) Plain Floor Trap with Top tile & Strainer 75 mm	7.00	144.00	Each	1008.00
80	L) Rubber Ring, (b) 110 mm	15.00	17.00	Each	255.00
81	C)Rubber Lubricant 500 ML	1.00	187.00	500 ML	187.00
82	D)Solvent Cement 250 ML	1.00	103.00	250 ML	103.00
83	Labour for fitting and fixing U.P.V.C. pipes for above ground work including cost of jointing materials etc. fitting and fixing all necessary specials, cutting pipes, cutting holes in total pipeline including specials. (B) Under ground, (ii) 110 mm dia. PWD S&P Schedule, (P. - 74, Item. No. - 24 (B)	25.00	84.00	Mtr	2100.00

Sl.No	Item Description & Item No.	Quantity	Rate	Unit	Amount
84	Supplying, fitting & fixing UPVC pipes A- Type and fittings conforming to IS:13592-1992 with all necessary clamps nails, including making holes in walls, floor etc. cutting trenches in any soil through masonry concrete structures etc if necessary and mending good damages including joining with jointing materials (Span Yarn, Valamoid/Bitumen/M-Seal etc) complete. A) UPVC Pipes: (i) 75 mm. Dia. (P. - 212, Item. No. - 21 (A)(i) , (B),(c),(i) & (B), (d),(i), Pwd volume- i, 2017)	30.00	188.00	Mtr	5640.00
85	B) UPVC Fittings: c) Bend 87.5 degree (i) 75 mm. Dia.	6.00	84.00	Mtr	504.00
86	B) UPVC Fittings: d) Shoe (i) 75 mm. Dia.	2.00	78.00	Mtr	156.00
87	Constructing Inspection pit of inside measurement 600mm X 600mm X upto 600mm (depth) with 250 mm thick 1st. class brick work in cement mortar (1:4) on all sides, bottom of the pit consisting of 100 mm thick cement concrete (1:3:6) with stone chips over a layer of jhama brick flat soling, 15 mm thick (1:4) cement plaster to inside walls and out-side walls upto G.L. and 20 mm.thick (1:4) plaster to bottom of the pit, providing necessary invert with cement concrete (1:3:6) with stone chips as per direction, neat cement finishing to entire internal surfaces, top of the pit covered with 100 mm thick R.C.C. slab (1:1.5:3) with stone chips and necessary reinforcements upto 1% and shuttering including 6 mm thick cement plaster (1:4) in all external surfaces of the slab and one 560 mm dia. R.C.C. manhole cover of approved make supplied, fitted and fixed in the slab with necessary fittings, necessary earthwork in excavation in all sorts of soil, filling sides of the pit with earth and removing spoils after work complete in all respect with all costs of labour and materials. i) With Pakur variety (Other than SAIL/TATA/RINL). PWD S&P Schedule, S.P.87,Item No-1/(i), 7th Corrigenda Volume ii	3.00	7248.00 6679.00	Each	21744.00 20037.00

SL. NO	Item Description & Item No.	Quantity	Rate	Unit	Amount
88	<p>Construction of septic tank of different capacities as per approved drawing with 1st class brick work in cement mortar (1:4) including two 560 mm dia. R.C.C. manhole cover (heavy type) of approved make supplied, fitted and fixed in the 100mm thick R.C.C (1:1.5:3) top slab with necessary fittings, 20mm thick cement plaster (4 : 1) with neat cement finish to the internal surfaces and 15 mm thick cement plaster (4 : 1) to outside wall upto 200 mm below G.L. floor finished with 25 mm thick grey artificial stone over 100 mm thick R.C.C(1:1.5:3) bottom slab including supplying, fitting and fixing all necessary specials, fittings, S.W. tees, C.I. foot rest etc. including excavation earth in all sorts of soil, shoring, bailing out and pumping out water as necessary, ramming, dressing the bed and refilling the sides of the tanks with earth, removing spoils, filling up the chamber with clear water, removing foreign materials from the chamber and including constructing attached inspection pit as per approved drawing and connecting all necessary pipes, joints etc. with internal plaster work and artificial stone flooring is to be done with admixture of water proofing compound @ 0.5% by weight of cement with all costs of labour and materials.</p> <p>(ii) For 20 users A) With Pakur variety. (JSW/JSPL/SHYAM/SRMB/ELECTROSTEEL/SSL) PWD S&P Schedule, S.P.88, Item No-3(ii)(A) 7th Corrigenda Volume ii</p>	1.00	48162.00 45312.00	Each	48162.00 45312.00
89	<p>Construction of circular soak well 2.5 metre deep in all types of sandy soils with dry brick work upto 1.6 metre from the bottom having 150 mm intermediate cement brick work (1:4) band all round and cement brick work (1:4) upto 0.90 metre from top with 20mm thick cement plastering (1:4) to inside face upto the depth of cement brick work, 15mm thick cement plaster (1:4) on outer face from top of the well upto G.L. and 6 mm thick cement plaster (1:4) on top of the R.C.C. cover slab including filling bottom 1.00 metre of inside of the well with brick metal (50 mm to 63 mm size) including R.C.C. cover slab of 100 mm thick with cement conc (1:1.5:3) with stone chips with necessary reinforcement and shuttering including one 560 mm dia. R.C.C. manhole cover (heavy type) of approved make supplied, fitted and fixed in the cover slab with necessary fittings, making necessary arrangements for pipe connections, excavation of well including shoring, dewatering and removing the excess earth from the premises as per direction complete in all respect with all costs of labour and materials. With 250 mm thick dry brick work and 250 mm thick cement brick work (1:6) and 1.00m inside dia. (Other than SAIL/TATA/RINL) S.P.89, Item No-4 7th Corrigenda Volume ii</p>	1.00	16621.00 15329.00	Each	16621.00 15329.00

SL.NO	Item Description & Item No.	Quantity	Rate	Unit	Amount
90	Supplying, fitting and fixing towel rail with two brackets. (a) C.P. over brass (ii) 25 mm dia. and 600 mm long PWD S&P Schedule, p No 82 1 No- 22 (a)(ii)	2.00	430.00	Each	860.00
91	Supplying, fitting and fixing bevelled edged mirror 5.5 mm thick silver red as per I.S. 3438 / 1965 together with brass C.P. hinges. (ii) 600 mm X 450 mm PWD S&P Schedule, P-81, It-15(ii)	2.00	484.00	Each	968.00
92	Supplying, fitting and fixing soap holder. (b) Fibre glass Sanitary and plumbing work schedule P-82, It-18(b)	4.00	58.00	Each	232.00
93	Supplying, fitting and fixing glass shelf with aluminium guard rails. (a) Ordinary type with 5.5 mm sheet glass (i) 450 mm X 125 mm Sanitary and plumbing work schedule P-81, It-16(a)(i)	2.00	341.00	Each	682.00
					720618.71 732247.97
	Add S.G.S.T. @		9%		64855.68 65902.32
	Add C.G.S.T. @		9%		64855.68 65902.32
	Cost Of Civil Work				850330.07 864052.60
	Add L.W.C. @		1%		8503.30 8640.53
	Total Amount Including Labour.Wekfare.Cess.				858833.38 872693.13
	Add Contengency @3%				25509.90 25921.58
	Total Amount Including Labour.Welfare.essC. and contengency				884343.28 898614.71
	Say Rs.				884343.00 898615.00

Eighty four thousand Three hundred forty three only
(Rupees Eight lakhs ~~Ninety eight thousand Six hundred Fifteen only~~)

S.A.E
Dainhat Municipality
Sub-Assistant Engineer
Dainhat Municipality

Nodal Officer, SBM
Dainhat Municipality

Chairman
Dainhat Municipality
Chairman
Dainhat Municipality
VETTED



26.03.25
Jr. Engineer (Gr-A)
Burdwan Division
M. E. Directorate
Govt. of West Bengal



26/3/25
Assistant Engineer
Burdwan Division
M.E.Dte.
Govt. of W.B

26/3/25
Executive Engineer
Burdwan Division
M. E. Directorate
Govt. of West Bengal

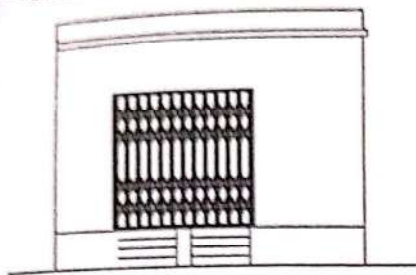
MODEL DRAWING FOR CONSTRUCTION OF C. T./P.T.
TOILET SEATS 4 Nos URINAL 5 Nos
MODEL NO.- G



FRONT ELEVATION

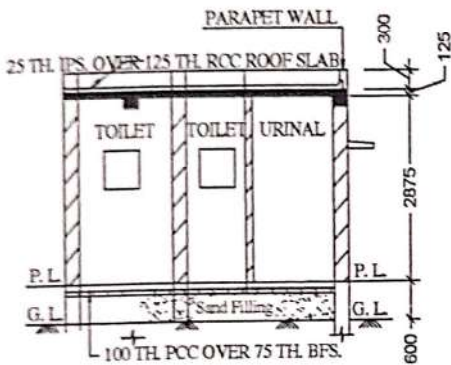

SECTION - 'A - A'

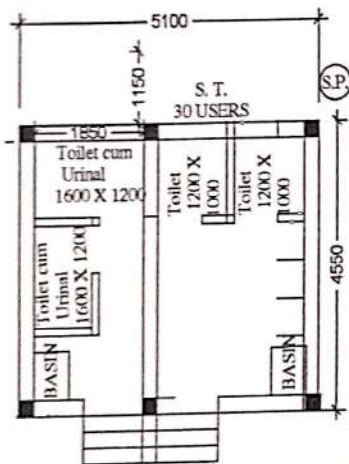

PLAN

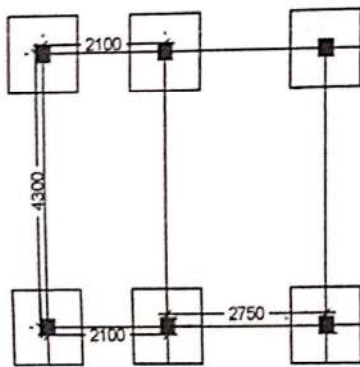

LAYOUT PLAN

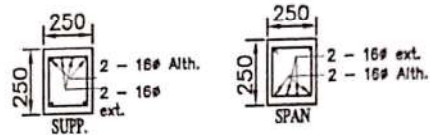

Details Of R.C.C Roof Slab & Beam

(SCALE - 1 : 25)

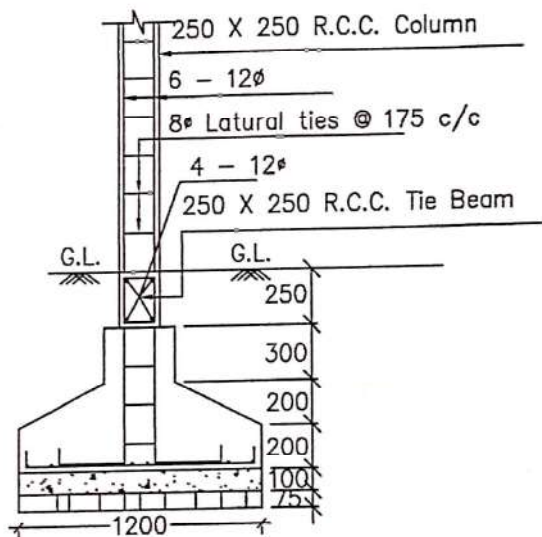

DETAILS OF R. C. C COLUMN

(SCALE - 1 : 25)

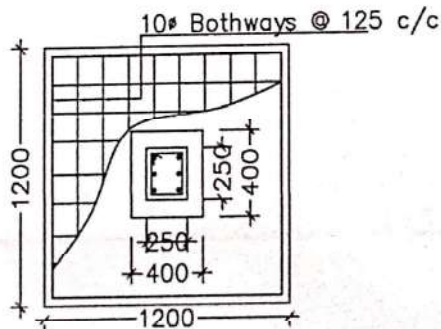

SM
Sub-Assistant Engineer
Dainhat Municipality

SCW J.
Nodal Officer, SBMI
Dainhat Municipality

Rey
Chairman
Dainhat Municipality



Analysis of Rate of Ordinary Cement Concrete (ANNEXURE - II,FORMAT-A) for

Dainhat Municipality

NAME OF DISTRICT=	Purba Bardhaman/Paschim Bardhaman	CONCRETE PROPORTION=			1:1½:3
Description of Items:-					Total Rs./cum.
step-1	Rate of item as per relevant section of PWD Bldg. Schedule [It. - 10, vide p-13(3rd corrigenda)]				Rs 4,243.00
step-2	Cost of Stone aggregate of diff. grading at nearest RLY. Ward as per (Table - 1 , P-308/309) (Consumption required for one cum of Concrete vide P-B60, sl no-3.)	20 mm	0.573 cum.	Rs 1,156.00	Rs 662.39
		10 mm	0.287 cum.	Rs 1,025.00	Rs 294.18
step-3	Cost of Carriage of Stone aggregate as per consumption required for one cum concrete as per (Table-2, P-310)	20 mm	0.573 cum.	Rs 690.50	Rs 395.66
		10 mm	0.287 cum.	Rs 690.50	Rs 198.17
step-4	Cost of Loading & unloading of stone aggregate bellow 40 mm nominal size. (Table -3, P-311)		0.860 cum.	Rs 58.00	Rs 49.88
Rate of 1:1½:3 Concrete per CU.M.=					Rs 5,843.28
Burdwan In.	rail yard to Work Site distance=	65	KM		
carriage	Ccot/KM	Total			
0-5	124	Rs 124.00			
5 to 10	10.9	Rs 54.50			
10 to 20	10.1	Rs 101.00			
20 to 50	9.5	Rs 285.00			
50 to 100	8.4	Rs 126.00			
>100	7.9	Rs -			
Total cost of carriage=		Rs 690.50			

CONTRACTOR SUPPLY (P-305), Annexure-1,Format-A(6th Corrigenda)

	Quantity		Rs./MT	Total Rs./cum.
	cum	MT	South Bengal	
Rate as per schedule=				Rs 5,843.28
Deduction of cost of cement	0.286	0.4118	Rs. 6,289.00	-2,589.81
Add cost of cement	0.286	0.4118	Rs. 5,717.00	Rs. 2,354.26
			TOTAL=	5607.73

 Sub-Assistant Engineer
 Dainhat Municipality

Analysis of Rate of Reinforcing Steel Supplied by Contactor
(Annexure -1, Format-B) for
Dainhat Municipality

NAME OF DISTRICT=	Bardhaman	TYPE OF STEEL=	JSW/JSPL/SHYAM/SRMB/BMSAL/ELECT ROSTEEL/SSL
GRADE OF STEEL=	Fe-415		

Description of Items:-		M.F	COST	AMOUNT/MT
step-1	Rate of item as per relevant section of PWD Bldg. Schedule. = [It no- 40.a.i (page-44)]	1.00	60003	Rs. 60,003.00
step-2	Deduct issue rate (per MT) of respective quality of Steel including 10% contractor profit, 2% sundries, water charges & 5% wastages X1.17=	1.17	-42792	-Rs. 50,066.64
step-3	Add basic price at outlet of steel of respective quality of Steel including 10% contractor profit, 2% sundries, water charges & 5% wastages X1.17=	1.17	37844	Rs. 44,277.48
step-4	Cost of carriage from outlet to site for 1.05 of steel= (Table-1, P-230, R&B)	1.05	Rs 82.00	Rs. 86.10
step-5	Cost of loading unloading charges for 1.05 of steel= (Chapter-1, 1.03_h, P-228, R&B)	1.05	72	Rs. 75.60

TOTAL= Rs. 54,375.54

kolkata	outlet to Work Site distance=	5
carriage	Csot/KM	Total
0-5	82	Rs 82.00
5 to 10	7.3	Rs -
10 to 20	6.7	Rs -
20 to 50	6.3	Rs -
50 to 100	5.6	Rs -
>100	5.3	Rs -
Total cost of carriage=		Rs 82.00

 Sub-Assistant Engineer
 Dainhat Municipality

**PROPOSED SITE PICTURE FOR CONSTRUCTION OF TOILET BLOCK (PT) (MODEL NO-G) AT
CHHAT GHAT IN WARD NO:02 UNDER DAINHAT MUNICIPALITY.
TOILET SEATS -4 NOS AND URINAL- 5 NOS**



HIMANSHU
New Toilet
Chhat Ghat Ward 2
13.04.2025 15:37
2262671 88 18983
H5XJ-JHW Paikpara 713502

Sub-Assistant Engineer
Dainhat Municipality

Nodal Officer, SBM
Dainhat Municipality

Chairman
Dainhat Municipality



**Dainhat municipality
ward no - 2**

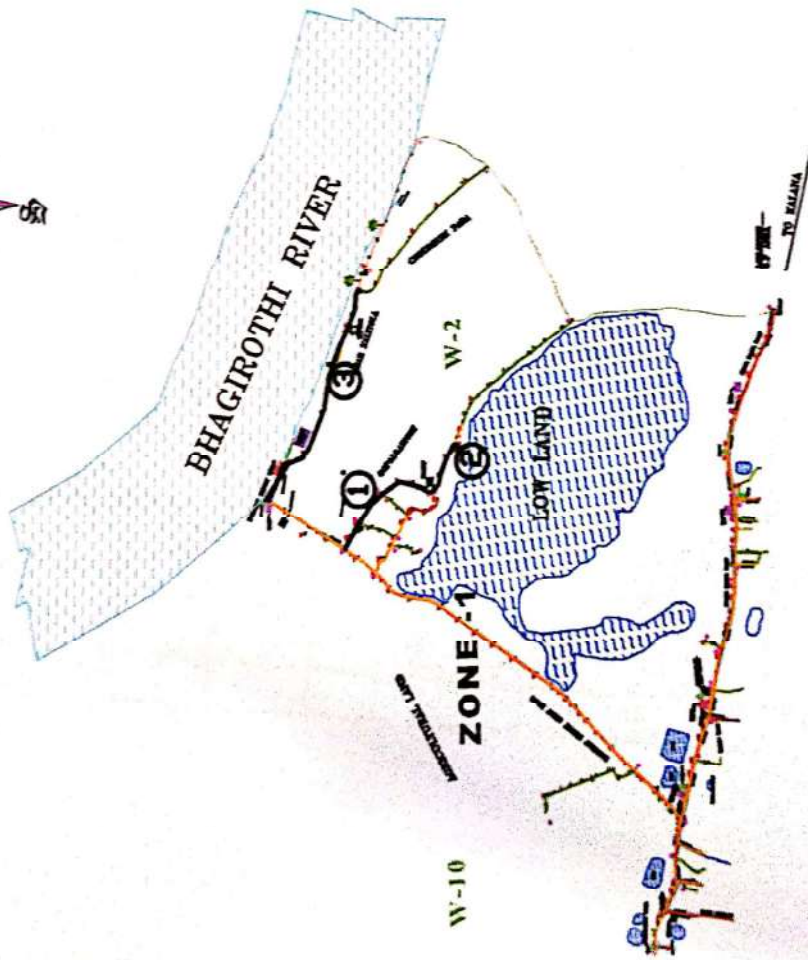

[Signature]
Chairman
Dainhat Municipality

[Signature]
Nodal Officer, SBM
Dainhat Municipality

[Signature]
Sub-Assistant Engineer
Dainhat Municipality

**ESTIMATE FOR CONSTRUCTION OF TOILET BLOCK (PT) (MODEL NO-G) AT CHHAT GHAT
IN WARD NO:-02 UNDER DAINHAT MUNICIPALITY.**

**TOILET SEATS -4 NOS AND URINAL- 5 NOS
(NON SCHEDULE WORKS)**

SL.NO	Item Description & Item No.	Quantity	UNIT	RATE	Amount
1	Standard plastic Dustbin(12lits)	4	Each	350.00	1400.00
2	Installation of Sinage	1	Each	2071.00	2071.00
3	Air Freshner (Pack of 4 nos.)	15	Each	216.00	3240.00
4	Air Freshner (Naphthaline 250gm.)	15	Each	210.00	3150.00
5	Supplying Paper Napkin	10	Each	50.00	500.00
6	Supplying Sanitary Napkin (Whisper or Similar make 50 pcs.)	20	Each	520.00	10400.00
7	Harpic (Blue 500 ml)	15	Each	300.00	4500.00
8	Harpic (Red 500 ml)	15	Each	150.00	2250.00
9	Gala double lip floor wiper	5	Each	350.00	1750.00
10	Colin Glass of Surface Cleaner	10	Lit	200.00	2000.00
11	Muriatic Acid	20	Lit	145.00	2900.00
12	Bleaching Powder	15	Kg	120.00	1800.00
13	Dettol,Lifebuy of similer make liquid soap	25	Lit	140.00	3500.00
14	Rubber & Hand Gloves	5	Pair	80.00	400.00
15	Double side plastic brush	5	Each	125.00	625.00
16	Plastic Broom	5	Each	170.00	850.00
17	Signage ACP Base & reflective vinyl (E8)	1	Each	3776.00	3776.00
18	SMS/any other ICT based feedback system (with number displayed on which SMS has to be sent) (A9)	1	Each	5000.00	5000.00
19	Glow sign board Name and contact details of the following are displayed prominently- Toilet identification number ,name of ULB under whose jurisdiction toilet is covered, ward Number and maintenance authority prominently displayed for each toilet block Supervisor, Supervisor's agency and area Sanitary Inspector (D3)	1	Each	5000.00	5000.00
20	Mini Tulu Pump	1	Each	4000.00	4000.00
21	Supplying and fixing sinage with fixing stand post for Public toilet for visible to passersby	1	Each	1000.00	1000.00
22	Supplying roaster/register for keeping account of Regular cleaning (D1)	1	Each	200.00	200.00
23	Lettering on toilet wall for display of name and contact details of ULB, Ward number and name of maintenance authority, sanitary inspector, etc(D3)	1	Each	1000.00	1000.00
Total Rs :-					61312.00
Add for Labour welfare Cess @ 1 %					613.12
Total Rs :-					61925.12
Add for Contingency @ 3 %					1839.36
Total Rs :-					63764.48
Say Rs:-					63764.00

(Rupee Sixty three thousand seven hundred sixty four only)



S.A.E
Dainhat Municipality

Nodal Officer, SBM
Dainhat Municipality,

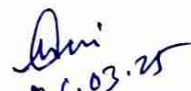
Chairman
Dainhat Municipality

26.03.25
Jr. Engineer (Gr.-A)
Burdwan Division
M. E. Directorate
Govt. of West Bengal

26/3/25
Assistant Engineer
Burdwan Division
M.E.Dia.
Govt. of W.B.

VETTED

26/3/25
Executive Engineer
Burdwan Division
M. E. Directorate
Govt. of West Bengal

**NAME OF WORK:- ESTIMATE FOR ELECTRICAL WORK OF PUBLIC TOILET AT CHHAT GHAT IN WARD
NO -02 UNDER DAINHAT MUNICIPALITY OF WEST BENGAL.,
(MODEL NO - G)**

* As per PWD & I & WD schedule district charges will be applicable on PWD & I & WD schedule items

* No district charges will be applicable on non-schedule items

Sl No.	Item Description	Unit	Quantity	Rate	Add dist. Ch.	(Sum) Rate	Amount
1	Distribution wiring in 2 x 22/0.3 (1.5 sqmm) single core stranded 'FR' PVC insulated & unsheathed copper wire (Brand approved by EIC) in 20mm size PVC rigid conduit 'FR' (Precision make), with 1x22/0.3 (1.5 sqmm) single core stranded 'FR' PVC insulated & unsheathed copper wire for ECC, to light/fan/call bell points with Piano Key type switch fixed on MS CRC sheet metal (16 SWG) switch board cum JB on wall complete with 2 no. suitable size "Ph & N" copper bar incl. bakelite/Perspex (wall matching color) top cover 3 mm thick and incl. 175mmx100mmx65mm inspection box, making earthing attachment, painting the MS box and mending good the damages to original finish. [PWD Schedule Page No-E-14 Item No-2a] Average run 5mtr.	Point	16	612.00	18.36	630.36	10085.76
2	Distribution wiring in 1.1 KV grade 22/0.3 (1.5 sqmm) single core stranded 'FR' PVC insulated & unsheathed copper wire (Brand approved by EIC) in 20mm size PVC rigid conduit 'FR' (Precision make), with 1.1 KV grade 1 x 22/0.3 (1.5 sqmm) single core stranded 'FR' PVC insulated & unsheathed copper wire as ECC, to 5A 3 pin flush type plug socket & Piano Key type switch fixed on MS CRC sheet metal (16 SWG) switch board cum JB on wall incl. bakelite/Perspex (wall matching color) top cover 3 mm thick and incl. painting the MS box and mending good the damages to original finish On Board (only for pay counter) [PWD Schedule Page No-E-15; I-4a]	Point	1	67.00	2.01	69.01	69.01
3	Supplying and fixing 240V 32A Double Pole AC Type 30mA RCCB. (Complete Set) (ISI marked) [Make-Legrand] (Cat No 4113/95) [Legrand Page No-92]	Nos	1	5942.00	Not applicable	5942.00	5942.00
4	Distribution wiring in 1.1 KV single core stranded 'FR' PVC insulated & unsheathed copper wire (Brand approved by EIC) in 20mm size PVC rigid conduit 'FR' (Precision make) incl. necy. fittings as required 2 x 36/0.3 (2.5 sqmm) + 1 x 22/0.3 (1.5 sqmm) ECC [PWD Schedule Page No-E-14 Item No-1a(ii)]	mtr	15	119.00	3.57	122.57	1838.55
	Total forwarded to next page-						17935.32

Sl No.	Item Description	Unit	Quantity	Rate	Add dist. Ch.	(Sum) Rate	Amount
	Blance from P-01						17935.32
5	Supplying and fixing double-door SPN MCB Distribution Board with IP-42/43 protection, concealed in wall after cutting the wall & mending good the damages to original finish incl. Inter connection with suitable size of copper wire and neutral link & provision for earthing attachment. a) For (2+6 way) (Make -Havells) (2+4) way [PWD Schedule Page No-D-9;Item No-13]	No	1	1073.00 935.00	32.19	1105.19 963.05	1105.19 963.05
6	Supplying and fixing 240/415 V MCB of Breaking capacity 10kA & C characteristics on din rail of existing DBs and necessary connection 6-32A SP MCB (Make -Havells) [PWD Schedule Page No-D-6;Item No-7]	Nos	4	168.00	5.04	173.04	692.16
7	Supplying and fixing 240/415 V MCB Isolator on din rail of existing DBs and necessary connection. 40A DP MCB Isolator (Make -Havells) [PWD Schedule Page No-D-5;Item No-6]	Nos	1	208.00	6.24	214.24	214.24
8	Supply of TMC501 conventional industrial batten (Philips make) LED Tube,model no- TMC501 P1xT-LED 22W P3241 (WB I & WD schedule P-113, I- 5:3 F.22)	Nos	4	451.00	9.02	460.02	1840.08
9	Fixing only single/twin flurosent light fitting complete with all accessories directly on wall/ceiling by screws etc.. [PWD Schedule Page No-C-2;Item No-14a]	Nos	4	86.00	2.58	88.58	354.32
10	Supply & fixing Bulk head light fittings with die cast aluminium housing frosted/clear glass on wall/ceiling incl S/F 9 watt LED Lamp complete set. [Make - Havells] (PWD sch - Page-D-13, I-23)	Nos	6	579.00	17.37	671.37	4028.22
11	Supply & fixing smart bright street light complete with all accessories to be fixed from the wall of building or on pole incl. making holes /providing clamping arrangement & necy. GI reducer as required.S&F 40 mm GI Pipe 1.5 mtr average length & s&f necy length of 1.5 sqmm pvc insulated single core copper wire & making connections as required & mending good damages incl wall paingting. (30 Watt) (Make - Bajaj) [WB I&WD sch P-111, I-f.9.0.2]	Nos	1	3016.00	60.32	3076.32	3076.32
12	Supply of 12" domestic metal exhaust fan 12" 230V 50 Hz SWEEP. TRANS AIR - (Make-Crompton/Havells/Bajaj) (UD & MA schedule P-14, I-5))	Nos	3	2093.00	Not applicable	2093.00	6279.00
	Total forwarded to next page-						35524.85

Sl No.	Item Description	Unit	Quantity	Rate	Add dist. Ch.	(Sum) Rate	Amount
	Blance from P-02						35524.85
13	Fixing only exhaust fan after making hole in wall and making good damages and smooth cement finish etc. as practicable as possible and providing necy. length of PVC insulated wire and making connection for exhaust of following diameter: 30 cm (12") [PWD Schedule Page No-C-4;Item No-28(b)]	Nos	3	329.00	9.87	338.87	1016.61
14	Fixing only louver shutter/cowl on wall with necy. bolts & nuts (6 mm dia x 62 mm long) For 30 cm(12") Exhaust fan [PWD Schedule Page No-C-4;Item No-30(b)]	Nos	3	110.00	3.30	113.30	339.90
15	S/F 240V 25A Modular type starter (brand approved by EIC)with 25 A. Modular switch DP MCB (C-Curve)and 4 Module G.I. Moduar type switch board with 4 Module Top Cover Plate flushed in wall incl. S/F switch board and Cover Plate and making necy. Connections with PVC Copper wire and earth connectivity wire etc. as per schedule [for Pump] [PWD Schedule Page No-E-19, Item No-17] (Please follow in details)	Nos	1	784.00	23.52	807.52	807.52
16	Supply of 240V A.C Ceiling Fan (48" sweep,1200 mm complete) [Make-Crompton [for counter only] (UD & MA schedule P- 23, I- 70)	Each	1	2283.00	Not applicable	2283.00	2283.00
17	Fixing only Ceiling Fan [PWD sch P- C-3, I-21(a)]	Each	1	66.00	1.98	67.98	67.98
18	Supply & Fixing 240 V, 16/20 A Piano key type switch (Brand approved by EIC) on sheet metal switch board incl. S & F 100x100x65mm MS (16SWG) switch board and bakelite/perspex top cover of 3mm thick by Brass screws after making housing for switch by cutting bakelite/perspex cover and making necessary connections as required. (For Hand Dryer machine) [PWD sch P- E-6, I-17(b)]	Each	2	201.00	6.03	207.03	414.06
19	Supply and Fixing of 2 mm Polyvinyl glow sign board made of 22 SWG GI sheet box with 1"X1" aluminum channel for fixing the vinyl board after necessary cutting the letter as required & s/f LED tube light fittings along with all accessories. (16 sqft @495.00/sqft) (UD & MA schedule P-14, I-4)	Nos	1	7920.00	Not applicable	7920.00	7920.00

20	Earthing installation by GI earth Spike (1830 X 20 mm) including SSWG GI EarthWire & GI nuts, bolts, washer etc.	Nos	1	450.00	Not applicable	450.00	450.00
Total (A)						48681.78	48823.92
Add 18% GST ON A =(B)						8762.72	8788.81
TOTAL A+B =(C)						57444.50	57612.23
Add 1% Cess ON C						574.44	576.12
Add 3% Contingency ON C						1723.33	1728.37
TOTAL INCLUDING ALL						59742.27	59916.71
Say Rs.							59917.00
Service Connection Charges as per Quotation							

Say Rs. 59,742.00

(Rupees Fifty nine thousand nine hundred Seventeen only)

 Rabindranath Mukhopadhyay
 S.A.E
 Dainhat Municipality

 Electrical Supervisor
 S.C.C. No.-
 20211710211031



 Chairman
 Dainhat Municipality



 Nodal Officer, SBM
 Dainhat Municipality

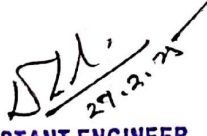

Technically Vetted Rs. 59,742/-
 (Rupees fifty nine thousand nine hundred forty two)

 Junior Engineer
 Electrical & Mechanical Division
 SUDA



 ASSISTANT ENGINEER
 ELECTRICAL & MECHANICAL DIVISION
 SUDA

 Executive Engineer (E/M)
 O/O the Secretary M.E. Dte.
 Government of West Bengal

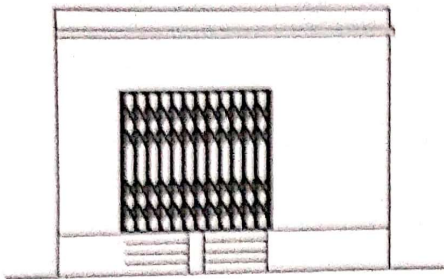
MODEL DRAWING FOR CONSTRUCTION OF C. T./P.T.
TOILET SEATS 4 Nos URINAL 5 Nos
MODEL NO.- G

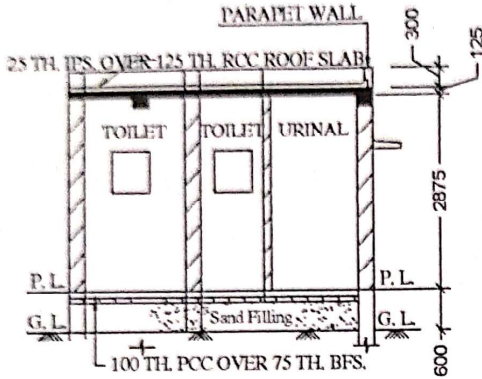

FRONT ELEVATION



SECTION - 'A - A'

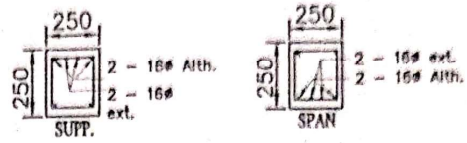

Details Of R.C.C Roof Slab & Beam
(SCALE - 1 : 25)

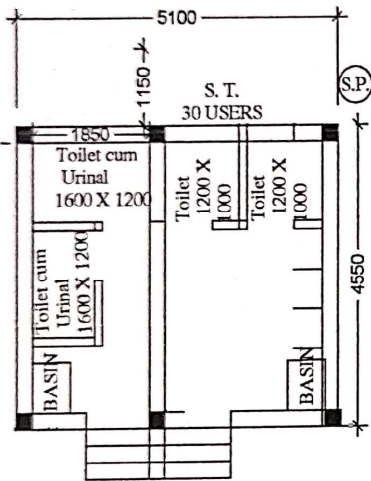

PLAN

BHLP → 06
TL → 04
EF → 03
OL → 01
CF → 01
G.S.B → 01
16 pts

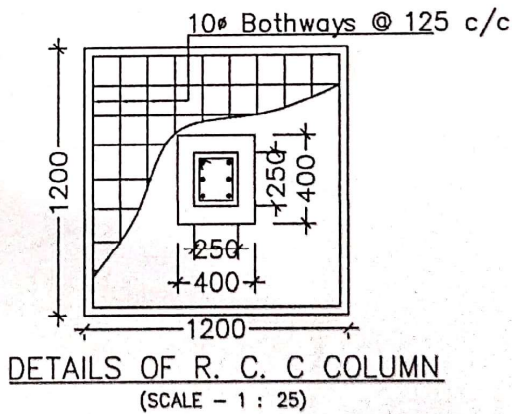
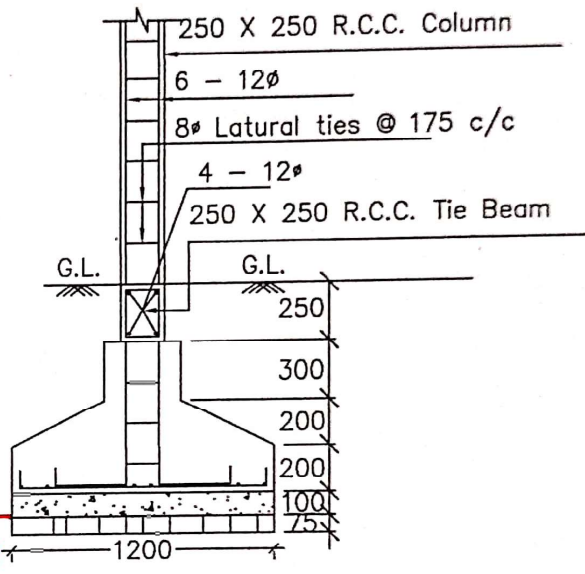

DETAILS OF R. C. C COLUMN
(SCALE - 1 : 25)

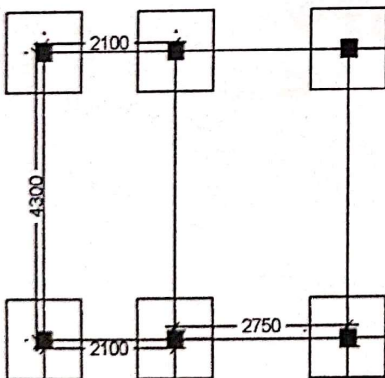

LAYOUT PLAN

[Signature]
Sub-Assistant Engineer
Dainhat Municipality

[Signature]
Nodal Officer, SBM
Dainhat Municipality



[Signature]
Chairman
Dainhat Municipality