

ESTIMATE FOR CONSTRUCTION OF COMMUNITY TOILET AT BYPASS BESIDE URBAN PRIMARY HEALTH CENTER PLOT NO. 228, MOUZA-FAUZILLABAD, JL-96, WARD NO- 09 UNDER SAINTHIA MUNICIPALITY OF WEST BENGAL (MODEL NO - G)

TOILET SEATS -4 NOS AND URINAL - 5 NOS

Reference of schedule of Rate :- PWD (W.B.), BUILDING WORKS, [With effect from 01.11.2017]
Incorporation of GST Act, 2017 & All addenda & Corrigenda of SOR, 01.12.2015.
PWD schedule of rates: Building and Sanitary & Plumbing w.e.f 01.11.2017

SL.NO	Item Description & Item No.	Quantity	Rate	Unit	Amount
1	Earth work in excavation of foundation trenches or drains, in all sorts of soil (including mixed soil but excluding laterite or sandstone) including removing, spreading or stacking the spoils within a lead of 75 m. as directed. The item includes necessary trimming the sides of trenches, levelling, dressing and ramming the bottom, bailing out water as required complete. (a) Depth of excavation not exceeding 1,500 mm. PWD Building Works schedule Page - 1, Item -2.a	8.696	119.27	Cu.m	1037.17
2	Earth work in filling in foundation trenches or plinth with good earth, in layers not exceeding 150 mm. including watering and ramming etc. layer by layer complete. (Payment to be made on the basis of measurement of finished quantity of work). (a) With earth obtained from excavation of foundation. PWD Building Works schedule, Page - 1, Item -3.a	2.899	77.54	Cum	224.79
3	(A) Filling in foundation or plinth by silver sand in layers not exceeding 150 mm as directed and consolidating the same by thorough saturation with water, ramming complete including the cost of supply of sand. (payment to be made on measurement of finished quantity) PWD Building Works schedule, Page - 2, Item -4.a	7.542	572.55	Cum	4318.17
4	Single Brick Flat Soling of picked jhama bricks including ramming and dressing bed to proper level and filling joints with local sand. PWD Building Works schedule, Page- 14, Item - 1 (Corri. Page-01, Date-04-06-2018)	37.100	266.00	Sqm	9868.60
5	Ordinary Cement concrete (mix 1:1.5:3) with graded stone chips (20 mm nominal size) excluding shuttering and reinforcement, if any, in ground floor as per relevant IS codes. a) Pakur Variety /Chandil Variety PWD Building Works schedule, p-26 Item 10 a (Rate Analysis)	8.245	4846.48	Cum	39959.23
6	Cement concrete with graded stone ballast (40 mm size excluding shuttering) In ground floor (A) [Pakur Variety] (a) 1:3:6 proportion PWD Building Works schedule, Page -34, Item -22, 1(A,a) Date-04-06-2018) Rate Analysis1 (Corri. Page-3RD, Date-04-06-2018)	3.710	4105.52	m3	15231.48

SL.NO	Item Description & Item No.	Quantity	Rate	Unit	Amount
7	25mm. thick damp proof course with cement concrete with stone chips (1:1.5:3) [with graded stone aggregate 10 mm nominal size] and admixture of water proofing compound as per manufacturer's specification followed by two coat of polymer based paint, (1st coat after 4 to 5 days of concrete laying and 2 nd coat just before brick masonry work) as directed (cost of water proofing compound & polymer based paint to be paid separately).(Chequering not required over concrete or painted surface). [Note: - Waterproofing as per item 9, polymer based paint as per item 8 (a) of subhead C of Section (C). PWD Building Works schedule, Page -47, Item -1 (Rate Analysis)	5.963	173.00 169.16	Sqm	1031.60 1008.76
8	125 mm brick work with 1st class bricks in cement mortar (1:4) in ground floor. PWD Building Works schedule, Page -16, Item-16, cori page -3, date - 04.06.2018 (Rate Analysis)	27.000	584.53	Sq.M.	15782.31
9	Supplying and laying polythine sheet (150 gm/sq.m) over damp proof course or below flooring or roof terracing or foundation or foundation trenches. PWD Building Works schedule, Page -47, Item-3	23.210	24.00	Sq.M.	557.04
10	Hire and labour charges for shuttering with centering and necessary staging upto 4 m using approved stout props and thick hard wood planks of approved thickness with required bracing for concrete slabs, beams and columns, lintels curved or straight including fitting, fixing and striking out after completion of works (upto roof of ground floor) (f) 25 mm to 30 mm shuttering without staging in foundation PWD Building Works schedule, Page -42, Item- 36.f	16.250	205.00	Sqm	3331.25
11	Hire and labour charges for shuttering with centering and necessary staging upto 4 m using approved stout props and thick hard wood planks of approved thickness with required bracing for concrete slabs, beams and columns, lintels curved or straight including fitting, fixing and striking out after completion of works (upto roof of ground floor) (a) 25 mm to 30 mm thick wooden shuttering as per decision & direction of Engineer-In-Charge. PWD Building Works schedule, Page -42, Item- 36.a	42.780	363.00	Sqm	15529.14
12	Artificial stone in floor ,dado, staircase etc with cement mortar (1:2:4) with stone chips sized in panels as directed with topping made with ordinary or white cement (as necessary) and marble dust in proportion (1:2) including smooth finishing and rounding off corners including raking out joints or roughening of concrete surface and application of cement slurry before flooring works using cement @ 1.75 kg/ sq.m all complete including all materials and labour. In ground floor 3 mm thick topping using gray cement (ii) 25 mm PWD Building Works schedule, p-48 Item 6(ii)	23.205	269.00 240.01	Sq.m	6242.15 5569.43

SL.NO	Item Description & Item No.	Quantity	Rate	Unit	Amount
13	Reinforcement for reinforced concrete work in all sorts of structures including distribution bars, stirrups, binders etc initial straightening and removal of loose rust (if necessary), cutting to requisite length, hooking and bending to correct shape, placing in proper position and binding with 16 gauge black annealed wire at every intersection, complete as per drawing and direction. (a) For works in foundation and upto roof of ground floor/upto 4 m. (i) Tor steel/Mild Steel , JSPL/SWAYN/ELETRO/STEEL PWD Building Works schedule, Page - 43, Item - 40.a.i.1(Corri. 10th Page-01, Date-23-01-2020) (Rate Analysis)	0.786	54439.07	M.T.	42789.11
14	Collapsible gate with 40 mm x 10 mm x 6 mm Tee as top and bottom guide rail , 20 mm x 10 mm x 2 mm vertical channels 100 mm apart in full stretched position 20m x 5 mm MS flats as collapsible bracings properly riveted and washered including 38 mm steel roller including locking arrangements , fitted and fixed in position with lugs set in cement concrete including cutting necessary hives chasing etc in walls , floors etc and making good all damages . PWD Building Works schedule, Page -106, Item- .18	4.200	4330.00	Sqm	18186.00
15	Brick work with 1st class bricks in cement mortar (1:4) (a) Foundation and plinth ground floor PWD Building Works schedule, Page -15, Item-7.a (Rate Analysis)	4.628	4198.06	Cu.m	19428.62
16	Brick work with 1st class bricks in cement mortar (1:4) (b) superstructure ground floor PWD Building Works schedule, Page -15, Item-7.b (Rate Analysis)	17.888	4421.06	Cu.m	79083.92
17	Labour for Chipping of concrete surface before taking up Plastering work. PWD Building Works schedule, P-192, It-1	23.210	21.00	Sqm	487.41
18	Plaster (to wall, floor, ceiling etc.) with sand and cement mortar including rounding off or chamfering corners as directed and raking out joints including throating, nosing and drip course, scaffolding/staging where necessary (Ground floor).[Excluding cost of chipping over concrete surface] (i) With 1:6 cement mortar (c) 15 mm thick plaster PWD Building Works schedule, P-189 It- No. 1 (Rate Analysis)	184.280	132.55	Sqm	24426.31
19	Plaster (to wall, floor, ceiling etc.) with sand and cement mortar including rounding off or chamfering corners as directed and raking out joints including throating, nosing and drip course, scaffolding/staging where necessary (Ground floor).[Excluding cost of chipping over concrete surface] (ii) With 1:4 cement mortar (c) 10 mm thick plaster PWD Building Works schedule, P-189 It- No. 1 (ii)(c) (Rate Analysis)	23.210	119.55	Sqm	2774.76
20	Neat cement punning about 1.5 mm thick in wall ,dado, window sills, floors etc . Note cement 0.152 m3/100 m2 PWD Building Works schedule, P-192 It- No. 15	14.480	32.76	Sq.m	474.36
21	Supplying, fitting and fixing fibre reinforced polymer (FRP) Composite door frame as per approved section with glass fibre reinforced plastic moulded skins and a special sandwich core, so as to impart monolithic composite structure as per approved technology of Department of Science and Technology (DST) to satisfy IS: 4020 door testing performance criteria.. (i) 66mm x 90mm PWD Building Works schedule, P-115, It - 3 (i)	19.800	497.00	Mtr	9840.60

SL.NO	Item Description & Item No.	Quantity	Rate	Unit	Ammount
22	Supplying, fitting & fixing fibre reinforced polymer (FRP) Composite door shutters as per approved design with glass fibre reinforced plastic moulded skins and a special sandwich core, so as to impart monolitaheic composite structure as per approved technology of Department of Science and Technology (DST) to satisfy IS:4020 door testing performance criteria. In ground floor. ii) 25 mm thick PWD Building Works schedule,P-125, It- 14(ii)	6.300	2581.00	Sqm	16260.30
23	Anodised aluminium barrel / tower / socket bolt (full covered) of approved manufactured from extruded section conforming to I.S. 204/74 fitted and fixed with cadmium plated screws . (vii) 225mm long x 10mm dia. bolt. PWD Building Works schedule, P-144, It No. 26 (vii)	5.000	84.00	Each	420.00
24	Iron butt hinges of approved quality fitted and fixed with steel screws, with ISI mark. (viii) 100mm X 75mm X 3.50mm. PWD Building Works schedule, P-140, It No. -5 (viii)	15.000	66.00	Each	990.00
25	Anodised aluminium decorative handle (hexagonal / fluted) of approed quality fitted and fixed complete. (i) 150mm plate x 10mm dia rod x 12mm hexagonal/fluted. PWD Building Works schedule, Page -146 . Item no-31,(i)	10.000	87.00	Each	870.00
26	Iron hasp bolt of approved quality fitted and fixed complete (oxidised) with 16mm dia rod with concrete bolt and round fitting. b) 250mm long. PWD Building Works schedule, Page -141 . Item no-10 b)	5.000	159.00	Each	795.00
27	Supplying and laying chequered tiles of any shede and of approved quality with (1:1.5:3) cement concrete laied in pannels or patterns as directed in pavement ,footpath etc including necessary underlay 25 mm thick (avg)cement mortar (1:3) complete in all respect with all labour and materials .(Using cement slurry @4.4kg/sq.m at back side and @2.4 kg/sq.m for joint filling) . PWD Building Works schedule, Page -74 , Item no- 46(i) . 25 mm thick	4.000	453.00 456.00	sq.m	1812.00 1824.00
28	Rendering the Surface of walls and ceiling with White Cement base WATER PROOF wall putty of approved make & brand.(1.5 mm thick) In Ground Floor PWD Building Works schedule, PWD, P- 198, I - 5	207.500	122.00	Sqm	25315.00
29	Applying interior grade Acrylic Primer of approved quality and brand on plastered and concrete surface old or new surface to receive Distemper Acrylic emulsion paint including scraping and preparing the surface thoroughly , complete as per manufacturer's specification and as per direction of the E-I-C (Ground Floor) (b) Two Coats PWD Building Works schedule, Page -74 , Item no- 46(i) .	52.680	44.20	m2	2328.46
30	Dry Destempering interial walls or ceiling including cleaning, washing, smoothening surface (b) two coats PWD Building Works schedule, Page -196 , Item no- 9(b) .	52.680	49.00	m2	2581.32

SL.NO	Item Description & Item No.	Quantity	Rate	Unit	Ammount
31	Applying exterior grade Acrylic Primer of approved quality and brand on plastered or concrete surface old or new surface to receive Decorative Textured (Marrrt Finish) or Smooth Finish Acrylic exterior emulsion paint including scraping and preparing the surface thoroughly , complete as per manufacturer's specification and as per direction of the EIC in Ground Floor (b) two coats. PWD Building Works schedule, Page -196 , Item no- 8(b)	72.390	45.10	m2	3264.79
32	Protective and Decorative Acrylic Exterior emulsion paint of approved quality, as per manufacturer's specification and as per dirction of EIC to be applied overf Acrylic primer as required. The rate includes cost of materials, labour, scaffolding and all incedental charges but excluding the cost of primer in ground floor (two coats)(a) normal acrylic emulsion. PWD Building Works schedule, Page -197 , Item no- 17(a)	72.390	67.00	m2	4850.13
33	(b) Priming one coat on timber or plastered surface with synthetic oil bound primer of approved quality including smoothening surfaces by sand papering etc. PWD Building Works schedule, Page -200 . Item no- 1 (b)	6.350	38.00	Sqm	241.30
34	(A) Painting with best quality synthetic enamel paint of approved make and brand including smoothening surface by sand papering etc. including using of approved putty etc. on the surface, if necessary : Page - 200 . Item no- 1 (b) (a) On timber or plastered surface : With super gloss (hi-gloss) - (iv) Two coats (with any shade except white) PWD Building Works schedule, Page -200 . Item no- 2(A)(a)(iv)	6.350	81.00	Sqm	514.35
35	(a) M.S.or W.I. Ornamental grill of approved design joints continuously welded with M.S, W.I. Flats and bars of windows, railing etc. fitted and fixed with necessary screws and lugs in ground floor.. (i) Grill weighing above 10 Kg./sq.mtr and up to 16 Kg./sq. mtr. PWD Building Works schedule, P-104 Item-13 A (i) (3rd Corrigendam Page No 91)	0.516	9888.00	Qntl	5102.21
36	a) Priming one coat on steel or other metal surface with synthetic oil bound primer of approved quality including smoothening surfaces by sand papering etc. PWD Building Works schedule, P/200 Item-1(a)	5.160	29.00	Sqm	149.64
37	(A) Painting with best quality synthetic enamel paint of approved make and brand including smoothening surface by sand papering etc. including using of approved putty etc. on the surface, if necessary : (b) On steel or other metal surface : (iv) Two coats (with any shade except white) PWD Building Works schedule, P-200 Item-2(b)(iv)	5.160	79.00	Sqm	407.64

SL.NO	Item Description & Item No.	Quantity	Rate	Unit	Amount
38	<p>Supplying and laying true to line and level vitrified tiles of approved brand (size not less than 600 mm X 600 mm X 10 mm thick) in floor, skirting etc. set in 20 mm sand cement mortar (1:4) and 2 mm thick cement slurry back side of tiles using cement @ 2.91Kg./sqM or using polymerised adhesive (6 mm thick layer applied directly over finished artificial stone floor/Mosaic etc without any backing course) laid after application slurry using 1.75 Kg of cement per sqM below mortar only, joints grouted with admixture of white cement and colouring Pigment to match with colour of tiles / epoxy grout materials of approved make as directed and removal of wax coating of top surface of tiles with warm water and polishing the tiles using soft and dry cloth upto mirror finish complete including the cost of materials, labour and all other incidental charges complete true to the manufacturer's specification and direction of Engineer-in-Charge. (White cement, synthetic adhesive and grout material to be supplied by the contrr[e])</p> <p>I (I) With application slurry @1.75 kg/ Sq.m, 20 mm sand cement mortar (1:4) & 2 mm thick cement slurry at back side of tiles, 0.2 kg/ Sq.m white cement for joint filling with pigment.</p> <p>(A) Deep Colour & White</p> <p>PWD Building Works schedule, Page-66 Item-36 (A)</p>	23.210	1676.00 1679.00	Sqm	38899.96 38969.59
39	<p>Supplying, fitting & fixing 1st quality Ceramic tiles in walls and floors to match with the existing work & 4 nos. of key stones (10mm) fixed with araldite at the back of each tile & finishing the joints with white cement mixed with colouring oxide if required to match the colour of tiles including roughening of concrete surface, if necessary or by synthetic adhesive & grout materials etc.</p> <p>B) Wall</p> <p>Area of each tile above 0.09 Sq.m ii)</p> <p>Other than Coloured decorative including white</p> <p>PWD Building Works schedule, page-64, Item:35.(B.) (b).(ii) (3rd Corrigendam ,Page 36)</p>	82.430	1047.00 1029.00	Sqm	86304.21 84820.47
40	<p>Supplying profiles of required section made of Aluminium Alloy Extrusions conforming to IS: 732-1983 and IS: 1285- 1975; Anodized (with required film thickness and specified colour / natural) matt finished conforming to IS: 1868-1983 for fabrication of composit door, sliding & casement windows, partitions, formed of basic sections of any ISI embossed / certified make and brand as per direction of Engineer - In- Charge. (Payment will be made on finished length of the work).</p> <p>(A) In 10-12 Micron thickness Annodizing film</p> <p>l) Natural white h) Louvered window. i)</p> <p>Top, bottom and side member.</p> <p>PWD Building Works schedule, PWD, P-233, I- 1(h) i</p>	8.400	183.00	M	1537.20
41	ii) Louvered Section.	7.200	658.00	M	4737.60
42	iii) Cleat angle (Non-annodized).	6.480	263.00	M	1704.24
43	<p>Supplying bubble free float glass of approved make and brand conforming to IS: 2835-1987.</p> <p>iv) 5mm thick coloured / tinted / smoke glass.</p> <p>PWD Building Works schedule, P-243, I -9</p>	1.080	585.00	Sq.M.	631.80
44	<p>Painting block letters or digits in Black Japan or any approved paint as per direction.</p> <p>e) Size above 7.5 cm. and upto 10 cm.</p> <p>PWD Building Works schedule, P-268, It-17(e)</p>	450.000	12.00	Each	5400.00
45	<p>Supplying and planting of different plants / trees (supplying well grown plants bushy and healthy, minimum height as specified i.e. exposed height including all leads and lifts, carriage, handling, manuring applying pesticide and fertilizer etc.</p> <p>i) Furcaria Veriegated 10 to 12 leaves in height 20-30 cm in earthen pot of size 25 cm</p>	10.000	162.00	Each	1620.00

SL.NO	Item Description & Item No.	Quantity	Rate	Unit	Amount
46	x) Ficus blakii (F. Vivicon) well branched (Bushy) of height 120cm - 135 cm in earthen pot of size 30cm. PWD Building Works schedule, Page -261, It- 9 (x)	3.000	187.00	Each	561.00
47	xxvi) Areca Palm 4 - 5 suckers of height 90 cm to 105 cm in earthen pots of size 25 cm. PWD Building Works schedule, Page -261, It- 9 (xxvi)	3.000	127.00	Each	381.00
SANITARY AND PLUMBING WORKS					0.00
48	Supplying, fitting and fixing Anglo-Indian W.C. in white glazed vitreous china ware of approved make complete in position with necessary bolts, nuts etc. a) With 'P' trap (with vent) PWD S&P Schedule, page-79, item no -3 (a)	4.000	3104.00	Each	12416.00
49	Supplying, fitting and fixing Closet seat of approved make with lid and C.P. hinges, rubber buffer and brass screws complete .(b) Anglo Indian (i) Plastic (hallow type) White PWD S&P Schedule, page-81,item no 10.b.i	4.000	380.00	Each	1520.00
50	Supplying, fitting and fixing Flat back urinal (half stall urinal) in white vitreous chinaware of approved make in position with brass screws on 75 mm X 75 mm X 75 mm wooden blocks complete (ii) 470 mm X 280 mm X 340 mm PWD S&P Schedule, page.80,item no-6/(ii)	3.000	945.00	Each	2835.00
51	Supplying fitting and fixing squatting plate with integrated flushing in white vitreous set in cement concrete (6:3:1) with jhama chips complete. (Payment of concrete will be paid seperately) (I) 450 mm x 350 mm	2.000	881.00	each	1762.00
52	Supplying, fitting and fixing 10 litre P.V.C. low-down cistern conforming to I.S. specification with P.V.C. fittings complete,C.I. brackets including two coats of painting to bracket etc. PWD S&P Schedule, Page No.-36 Item No.-2,	4.000	1015.00	Nos	4060.00
53	Supplying,fitting and fixing 32 mm dia. Flush Pipe of approved make with necessary fixing materials and clamps complete. i) Polythene Flush Pipe PWD S&P Schedule, Page no 81. Item no. 11(i)	4.000	155.00	Each	620.00
54	Supplying, fitting and fixing urinal flush pipe fittings of approved brand. (a) C.P. urinal flush pipe fittings range of one PWD S&P Schedule, S.P.81,item-12/a	2.000	414.00	Each	828.00
55	Supplying, fitting and fixing white vitreous china best quality approved make wash basin with C.I. brackets on 75 mm X 75 mm wooden blocks, C.P. waste fittings of 32 mm dia., mending good all damages and painting the brackets with two coats of approved paint. (ii) 550 mm X 400 mm size PWD S&P Schedule, P-41, It 2 (ii)	2.000	2208.00	Each	4416.00
56	Supplying fitting and fixing pedestal of approved make for wash basin (White) PWD S&P Schedule, P-41, It 3	2.000	1497.00	Each	2994.00
57	Supplying,fitting and fixing approved brand P.V.C. CONNECTOR white flexible, with both ends coupling with heavy brass C.P. nut, 15 mm dia., (iii) 600 mm long PWD S&P Schedule, Page No.-43 Item No.-9-iii PWD,	5.000	107.00	Each	535.00
58	Supplying,fitting and fixing approved brand 32 mm dia.P.V.C. waste pipe, with PVC coupling at one end fitted with necessary clamps. (iv) 1050 mm long each PWD S&P Schedule, Page No.-43 Item No. 10-iv	2.000	91.00	Each	182.00

SL.NO	Item Description & Item No.	Quantity	Rate	Unit	Amount
59	(r) Hand Shower(Health Faucet) with 1mtr Flexible Tube with Wall Hook(Equivalent to Code No.573 & Model -ALLIED of Jaquar or similar). PWD S&P Schedule, Page No.-3 Item No.- 3 f,	5.000	1251.00	Each	6255.00
60	(a) (i) Chromium plated Bib Cock short body (Equivalent to Code No. 511 & Model - Tropical / Sumthing Special of ESSCO or similar brand). PWD S&P Schedule, Page No.-6 Item No.-7-a-i	7.000	539.00	Each	3773.00
61	(b) (i) Chromium plated Stop Cock (Equivalent to Code No. 513(A) & 513(B) & Model - Tropical / Sumthing Special of ESSCO or similar PWD S&P Schedule, Page No.-6 Item No.-7-b-i	5.000	493.00	Each	2465.00
62	Chromium plated angular Stop Cock with wall flange (Equivalent to Code No. 5053 & Model - Florentine of Jaquar or similar brand). PWD S&P Schedule, Page No.-6 Item No.-7-d-i,	5.000	815.00	Each	4075.00
63	Supplying, fitting and fixing pillar cock of approved make. a) (i) CP Pillar Cock - 15 mm. (Equivalent to Code No. 507 & Model - Tropical / Sumthing Special of ESSCO or similar brand). (P. No. - 45, Item. No. - 19(a)i, Pwd Sanitary Plumbing Schedule 2017)	2.000	555.00	Each	1110.00
64	Supplying, fitting and fixing PVC pipes of approved make of Schedule 80 (medium duty) conforming to ASTM D - 1785 and threaded to match with GI Pipes as per IS : 1239 (Part - I). with all necessary accessories, specials viz. socket, bend, tee, union, cross, elbo, nipple, long screw, reducing socket, reducing tee, short piece etc. fitted with holder bats clamps, including cutting pipes, making threads, fitting, fixing etc. complete in all respect including cost of all necessary fittings as required, jointing materials and two coats of painting with approved paint in any position above ground. (Payment will be made on the centre line measurements of total pipe line including all specials. No separate payment will be made for accessories, specials. Payment for painting will be made separately) (a) For Exposed Work PVC Pipes, 25 mm Page No.-12 Item No.-19-i(a), PWD,VOL-II , 2017-18	25.000	177.00	Mtr	4425.00
65	(a) (a) For Exposed Work PVC Pipes, 15 mm Page No.-12 Item No.-19-i(a), PWD,VOL-II , 2017-18	10.000	101.00	Mtr	1010.00
66	(b) For Concealed Work PVC Pipes, 15 mm Page No.-12 Item No.-19-i(b), PWD,VOL-II , 2017-18	10.000	137.00	Mtr	1370.00
67	Supplying and fitting fixing of gunmetal wheel valve of approved brand and make tested to 21 Kg per sq. cm. 25 mm dia(E5) PWD S&P Schedule P-5 It-5.vii)	2.000	778.00	Each	1556.00
68	Supplying P.V.C. water storage tank of approved quality with closed top with lid (Black) - Multilayer (b) 1000 litre capacity PWD S&P Schedule, page.37,item no-6 (b)	2.000	5128.00	Each	10256.00
69	Labour for hoisting plastic water storage tank. (i) Upto 1500 litre capacity. (a) Upto 1st story from G.L. PWD S&P Schedule, page.37,item no-10 (i)(a)	2.000	96.00	Each	192.00
70	Labour for punching hole in plastic water storage tank upto 50 mm dia. PWD S&P Schedule, (P. No. - 38, Item. No. - 13	4.000	19.00	Each	76.00
71	Supply of UPVC pipes (B Type) & fittings conforming to IS-13592-1992.(A) (i) Single Socketed 3 Meter Length, (b) 110 mm PWD S&P Schedule, Page No.-68 Item No. 23,(A)(i)(b)	30.000	292.00	Mtr	8760.00
72	(B) Fittings (i) Coupler, (b) 110 mm	8.000	85.00	Each	680.00
73	(ii) Plain Tee, (b) 110 mm	12.000	85.00	Each	1020.00
74	(iii) Door Tee, (b) 110 mm	10.000	195.00	Each	1950.00

SL.NO	Item Description & Item No.	Quantity	Rate	Unit	Amount
75	x) Bend 45°, (b) 110 mm	10.000	89.00	Each	890.00
76	xi) Door Bend (T.S.), (b) 110 mm	7.000	147.00	Each	1029.00
77	xvi) Pipe Clip, (b) 110 mm	30.000	21.00	Each	630.00
78	xvii) W.C. Connector (150 mm long) 125 X 110(W/WC Ring) 75 mm	4.000	142.00	Each	568.00
79	xxxi) Plain Floor Trap with Top tile & Strainer 75 mm	7.000	144.00	Each	1008.00
80	L) Rubber Ring, (b) 110 mm	15.000	17.00	Each	255.00
81	C)Rubber Lubricant 500 ML	1.000	187.00	500 ML	187.00
82	D)Solvent Cement 250 ML	1.000	103.00	250 ML	103.00
83	Labour for fitting and fixing U.P.V.C. pipes for above ground work including cost of jointing materials etc. fitting and fixing all necessary specials, cutting pipes, cutting holes in total pipeline including specials. (B) Under ground, (ii) 110 mm dia. PWD S&P Schedule, (P. - 74, Item. No. - 24 (B))	25.000	84.00	Mtr	2100.00
84	Supplying, fitting & fixing UPVC pipes A- Type and fittings conforming to IS:13592-1992 with all necessary clamps nails, including making holes in walls, floor etc. cutting trenches in any soil through masonry concrete structures etc if necessary and mending good damages including joining with jointing materials (Spun Yarn, Valamoid/Bitumen/M-Seal etc) complete. A) UPVC Pipes: (i) 75 mm. Dia. (P. - 212, Item. No. - 21 (A)(i) , (B),(c),(i) & (B), (d),(i), Pwd volume- i, 2017)	30.000	188.00	Mtr	5640.00
85	B) UPVC Fittings: c) Bend 87.5 degree (i) 75 mm. Dia.	6.000	84.00 95.00	Mtr	504.00 570.00
86	B) UPVC Fittings: d) Shoe (i) 75 mm. Dia.	2.000	78.00	Mtr	156.00
87	Constructing Inspection pit of inside measurement 600mm X 600mm X upto 600mm (depth) with 250 mm thick 1st. class brick work in cement mortar (1:4) on all sides, bottom of the pit consisting of 100 mm thick cement concrete (1:3:6) with stone chips over a layer of jhama brick flat soling, 15 mm thick (1:4) cement plaster to inside walls and out-side walls upto G.L. and 20 mm.thick (1:4) plaster to bottom of the pit, providing necessary invert with cement concrete (1:3:6) with stone chips as per direction, neat cement finishing to entire internal surfaces, top of the pit covered with 100 mm thick R.C.C. slab (1:1.5:3) with stone chips and necessary reinforcements upto 1% and shuttering including 6 mm thick cement plaster (1:4) in all external surfaces of the slab and one 560 mm dia. R.C.C. manhole cover of approved make supplied, fitted and fixed in the slab with necessary fittings, necessary earthwork in excavation in all sorts of soil, filling sides of the pit with earth and removing spoils after work complete in all respect with all costs of labour and materials. i) With Pakur variety (Other than SAIL/TATA/RINL). PWD S&P Schedule, S.P.87,Item No-1/(i), 7th Corrigenda Volume ii	3.000	6153.00	Each	18459.00

SL.NO	Item Description & Item No.	Quantity	Rate	Unit	Amount
88	<p>Construction of septic tank of different capacities as per approved drawing with 1st class brick work in cement mortar (1:4) including two 560 mm dia. R.C.C. manhole cover (heavy type) of approved make supplied, fitted and fixed in the 100mm thick R.C.C (1:1.5:3) top slab with necessary fittings, 20mm thick cement plaster (4 : 1) with neat cement finish to the internal surfaces and 15 mm thick cement plaster (4 : 1) to outside wall upto 200 mm below G.L floor finished with 25 mm thick grey artificial stone over 100 mm thick R.C.C(1:1.5:3) bottom slab including supplying, fitting and fixing all necessary specials, fittings, S.W. tees, C.I. foot rest etc. including excavation earth in all sorts of soil, shoring, bailing out and pumping out water as necessary, ramming, dressing the bed and refilling the sides of the tanks with earth, removing spoils, filling up the chamber with clear water, removing foreign materials from the chamber and including constructing attached inspection pit as per approved drawing and connecting all necessary pipes, joints etc. with internal plaster work and artificial stone flooring is to be done with admixture of water proofing compound @ 0.5% by weight of cement with all costs of labour and materials.</p> <p>(ii) For 20 users A) With Pakur variety. (JSW/JSPL/SHYAM/SRMB/ELECTROSTEEL/SSL) PWD S&P Schedule, S.P.88,Item No-3(ii)(A) 7th Corrigenda Volume ii</p>	1.000	42400.00	Each	42400.00
89	<p>Construction of circular soak well 2.5 metre deep in all types of sandy soils with dry brick work upto 1.6 metre from the bottom having 150 mm intermediate cement brick work (1:4) band all round and cement brick work (1:4) upto 0.90 metre from top with 20mm thick cement plastering (1:4) to inside face upto the depth of cement brick work, 15mm thick cement plaster (1:4) on outer face from top of the well upto G.L. and 6 mm thick cement plaster (1:4) on top of the R.C.C. cover slab including filling bottom 1.00 metre of inside of the well with brick metal (50 mm to 63 mm size) including R.C.C. cover slab of 100 mm thick with cement conc (1:1.5:3) with stone chips with necessary reinforcement and shuttering including one 560 mm dia. R.C.C. manhole cover (heavy type) of approved make supplied, fitted and fixed in the cover slab with necessary fittings, making necessary arrangements for pipe connections, excavation of well including shoring, dewatering and removing the excess earth from the premises as per direction complete in all respect with all costs of labour and materials. With 250 mm thick dry brick work and 250 mm thick cement brick work (1:6) and 1.00m inside dia. (Other than SAIL/TATA/RINL)</p>	1.000	13899.00	Each	13899.00
90	<p>Supplying, fitting and fixing towel rail with two brackets. (a) C.P. over brass (ii) 25 mm dia. and 600 mm long PWD S&P Schedule, p No 82 I No- 22 (a)(ii)</p>	2.000	430.00	Each	860.00
91	<p>Supplying, fitting and fixing bevelled edged mirror 5.5 mm thick silver red as per I.S. 3438 / 1965 together with brass C.P. hinges. (ii) 600 mm X 450 mm PWD S&P Schedule, P-81, It-15(ii)</p>	2.000	484.00	Each	968.00
92	<p>Supplying, fitting and fixing soap holder. (b) Fibre glass Sanitary and plumbing work schedule P-82, It-18(b)</p>	4.000	58.00	Each	232.00

SL.NO	Item Description & Item No.	Quantity	Rate	Unit	Amount
93	Supplying, fitting and fixing glass shelf with aluminium guard rails. (a) Ordinary type with 5.5 mm sheet glass (i) 450 mm X 125 mm Sanitary and plumbing work schedule P-81, It-16(a)(i)	2.000	341.00	Each	682.00
					687961.00
	Add S.G.S.T. @		9%		62099.47
	Add C.G.S.T. @		9%		62099.47
	Cost Of Civil Work			RS	811794.70
	Add Labour Welfare Cess. @		1%	RS	8117.95
	Total Amount Including L.abour Welfare Cess.			RS	819912.71
	Add Contengency @3%			RS	24353.84
	Total Amount Including L.W.C. and contengency			RS	844266.55
	Say Rs.			Say RS	844267.00
Rupees Eight Lakh FourtySeven Thousand Five Only					

Rupees Eight Lakh Fourty Four Thousand Two Hundred Sixty seven only.

Sainth
25.05.25
Jr. Engineer
Birbhum Division
M.E. Directorate
Govt. of West Bengal

Prepared by

Sub- Assistant Engineer
SAINTHIA MUNICIPALITY
Sainthia, Birbhum

Approved by

Chairman
SAINTHIA MUNICIPALITY
Sainthia, Birbhum

May be Vetted

Assistant Engineer
Birbhum Division
Municipal Engineering Directorate
Govt. of West Bengal

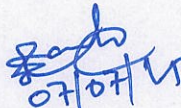
Executive Engineer
Birbhum Division
M E Dte.
Govt of W.B.

MODLE DRAWING FOR CONSTRUCTION OF C. T./P.T.
TOILET SEATS 4 Nos URINAL 5 Nos
MODLE NO.- G

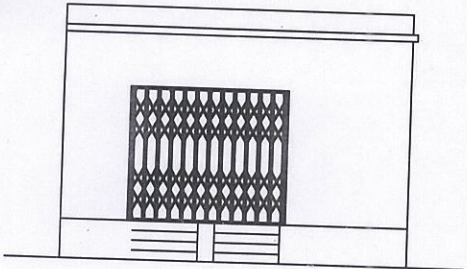

FRONT ELEVATION

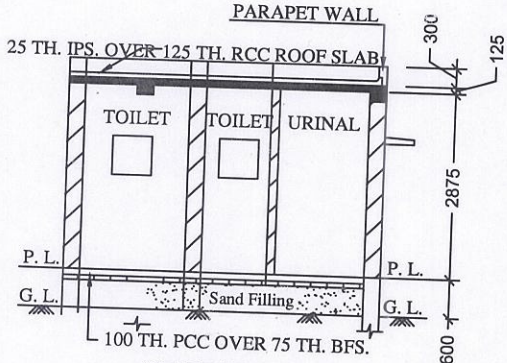

SECTION - 'A - A'

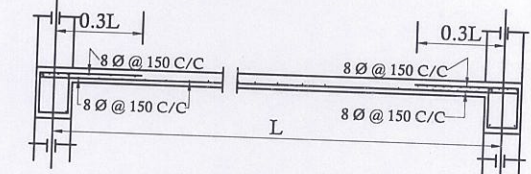
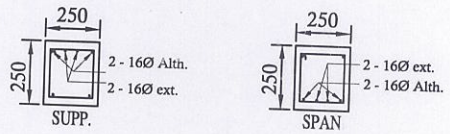

Details Of R.C.C Roof Slab & Beam
(SCALE - 1 : 25)

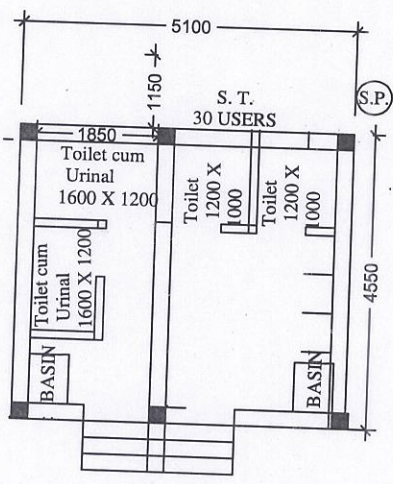

PLAN

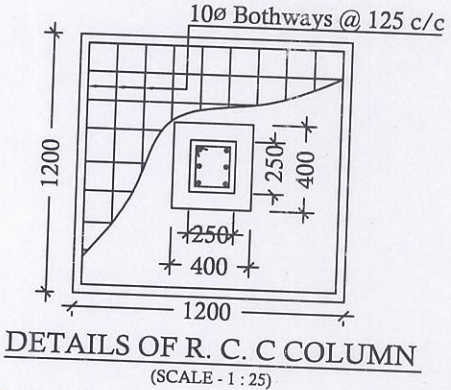
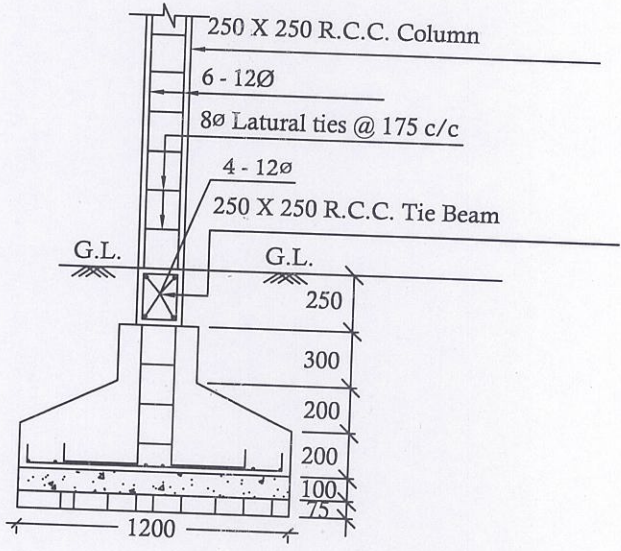

DETAILS OF R. C. C COLUMN
(SCALE - 1 : 25)

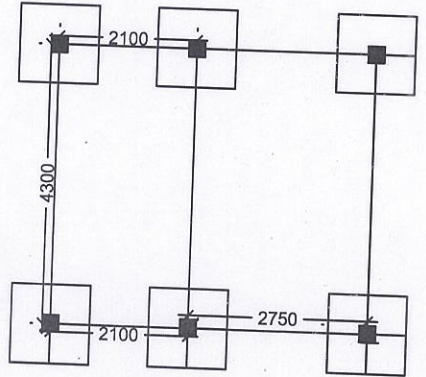

LAYOUT PLAN

Prepared by
[Signature]
3/16
2025
Sub- Assistant Engineer
SAINTHIA MUNICIPALITY
Sainthia, Birbhum

Approved by
[Signature]
Chairman
SAINTHIA MUNICIPALITY
Sainthia, Birbhum

2

**NAME OF WORK:- ESTIMATE FOR NON-SCHEDULED WORK OF 4 SEATED COMMUNITY TOILET AT BYPASS BESIDE
URBAN PRIMARY HEALTH CENTER, WARD-09 UNDER SAINTHIA MUNICIPALITY OF WEST BENGAL (MODEL NO-G)
[ASPIRATIONAL PARAMETER]**

*The rates of non-scheduled item as approved by SUDA.(vide Memo No 924/2021/7746 dated 05.03.2022)

* No district charges will be applicable on non-schedule items.

SL.NO	Item Description & Item No.	Quantity	Rate	Unit	Amount
1	Non Shedule Item Sl. No. 91-106 (Order as per SUDA) standard plastic dustbin (12lits)	2	350	Each	700.00
2	Sinage APC based & Reflective vinyl (E8)	2	3776	each	7552.00
3	Supplying and fixing sinage with fixing stand post for public toilet for visible to passersby	1	1000	Each	1000.00
4	Glow Sign board Name and contact details of the following are displayed prominently - Toilet Identification number , name of ULB under which jurisdiction toilet is coverwd , ward number and maintanance authority prominently displayed for each toilet block supervisor, supervisor's agency and area sanitary inspector.(D3)	1	5000	each	5000.00
5	Installation of Sinage	1	2071	each	2071.00
6	Air freshner(pack of 4nos)	1	216	Each	216.00
7	Air freshner (Napthaline 250 gm)	1	210	Each	210.00
8	Supplying paper Napkin	1	50	Each	50.00
9	Supplying Sanitary Napkin (Whisper or similar make 50 pcs)	1	520	Each	520.00
10	Harpic (blue 500 ml)	1	300	Each	300.00
11	Harpic (Red 500 ml)	1	150	Each	150.00
12	Gala double lip floor wiper	1	350	Each	350.00
13	Colin glass or surface cleaner	1	200	Lit	200.00
14	Muriatic Acid	1	145	Lit	145.00
15	Bleaching powder	1	120	Kg	120.00
16	Dettol ,lifeboy or similar make liquid soap	2	140	Lit	280.00
17	Rubber hand gloves	1	80	Pair	80.00
18	Double side plastic brush	1	125	Each	125.00
19	Plastic Broom	1	170	Each	170.00
20	SMS/any otherICT based feedback system (With number displayed on which SMS has to be sent) (A9)	1	5000	each	5000.00
21	Mini Tulu Pump	1	4000	each	4000.00
				BF	28239.00

Rs. 28239.00

22	supplying roaster /register for keeping acoount of regular cleanig	-31	200	Each	200.00 600.00
23	Lettering on Toilet Wall for display of name and contact details of ULB ward number and name of maintanance authority , saniinspector, etc.	1	1000	each	1000.00
				Rs.	29439.00 56509.00
	Add for Labour welfare Cess @ 1 %			Rs.	565.09
			Total	Rs.	29439.00 57074.09
	Add for Contingency @ 3 %			Rs.	1695.27 1712.22
				Rs.	883.17
			TOTAL	Rs.	58765.36 58786.31
				Say Rs.	30322.17 58765.00 58786.00
Rupees Fifty Eight Thousand Seven Hundred Eighty Six Only					Sixty nine. Rs. 30322.00

(Rupees thirty thousand three hundred twenty two) only

Sainthia
25.05.25
Jr. Engineer
Birbhum Division
Municipal Engineering Directorate
Govt. of West Bengal

Prepared by
[Signature]
25/05/2025
Sub- Assistant Engineer
SAINTHIA MUNICIPALITY
Sainthia, Birbhum

Approved by
[Signature]
Chairman
SAINTHIA MUNICIPALITY
Sainthia, Birbhum

May be Vetted
[Signature]
25/05/25
Assistant Engineer
Birbhum Division
Municipal Engineering Directorate
Govt. of West Bengal

**NAME OF WORK:- ESTIMATE FOR ELECTRICAL WORK OF 4 SEATED PUBLIC/COMMUNITY TOILET AT
BYPASS BESIDE URBAN PRIMARY HEALTH CENTER, WARD NO. - 09 UNDER SAINTHIA MUNICIPALITY OF
WEST BENGAL (MODEL NO - G)
[ASPIRATIONAL PARAMETER]**

* As per PWD & I & WD schedule district charges will be applicable on PWD & I & WD schedule items

* No district charges will be applicable on non-schedule items

Sl No.	Item Description	Unit	Quantity	Rate	Amount	Remarks
1	Distribution wiring in 2 x 22/0.3 (1.5 sqmm) single core stranded 'FR' PVC insulated & unsheathed copper wire (Brand approved by EIC) in 20mm size PVC rigid conduit 'FR' (Precision make), with 1x22/0.3 (1.5 sqmm) single core stranded 'FR' PVC insulated & unsheathed copper wire for ECC, to light/fan/call bell points with Piano Key type switch fixed on MS CRC sheet metal (16 SWG) switch board cum JB on wall complete with 2 no. suitable size "Ph & N" copper bar incl. bakelite/Perspex (wall matching color) top cover 3 mm thick and incl. 175mmx100mmx65mm inspection box, making earthing attachment, painting the MS box and mending good the damages to original finish. [PWD Schedule Page No-E-14 Item No-2a]	Point	17	642.60	10924.20	ADD DISTRICT CHARGES(5%)
	Average run 5 mtr					
2	Distribution wiring in 1.1 KV grade 22/0.3 (1.5 sqmm) single core stranded 'FR' PVC insulated & unsheathed copper wire (Brand approved by EIC) in 20mm size PVC rigid conduit 'FR' (Precision make), with 1.1 KV grade 1 x 22/0.3 (1.5 sqmm) single core stranded 'FR' PVC insulated & unsheathed copper wire as ECC, to 5A 3 pin flush type plug socket & Piano Key type switch fixed on MS CRC sheet metal (16 SWG) switch board cum JB on wall incl. bakelite/Perspex (wall matching color) top cover 3 mm thick and incl. painting the MS box and mending good the damages to original finish On Board (only for pay counter) [PWD Schedule Page No-E-15; I-4a]	Point	2	70.35	140.70	ADD DISTRICT CHARGES(5%)
3	Supplying and fixing 240V 32A Double Pole AC Type 30mA RCCB.(Complete Set) (ISI marked) [Make- Legrand] (Cat No 4113/95) [Legrand Page No-92]	Nos	1	5942.00	5942.00	NO DISTRICT CHARGES

4	Distribution wiring in 1.1 KV single core stranded 'FR' PVC insulated & unsheathed copper wire (Brand approved by EIC) in 20mm size PVC rigid conduit 'FR' (Precision make) incl. necy. fittings as required 2 x 36/0.3 (2.5 sqmm) + 1 x 22/0.3 (1.5 sqmm) ECC [PWD Schedule Page No-E-14 Item No-1a(ii)]	mtr	15	124.95	1874.25	ADD DISTRICT CHARGES(5%)
5	Supplying and fixing double-door SPN MCB Distribution Board with IP-42/43 protection, concealed in wall after cutting the wall & mending good the damages to original finish incl. Inter connection with suitable size of copper wire and neutral link & provision for earthing attachment. a) For (2+4 way) (Make -Havells) [PWD Schedule Page No-D-9;Item No-13]	No	1	981.75	981.75	ADD DISTRICT CHARGES(5%)
6	Supplying and fixing 240/415 V MCB of Breaking capacity 10kA & C characteristics on din rail of existing DBs and necessary connection 6-32A SP MCB (Make -Havells) [PWD Schedule Page No-D-6;Item No-7]	Nos	4	176.40	705.60	ADD DISTRICT CHARGES(5%)
7	Supplying and fixing 240/415 V MCB Isolator on din rail of existing DBs and necessary connection. 40A DP MCB Isolator (Make -Havells) [PWD Schedule Page No-D-5;Item No-6]	Nos	1	218.40	218.40	ADD DISTRICT CHARGES(5%)
8	Supply of TMC501 conventional industrial batten (Philips make) LED Tube,model no- TMC501 P1xT-LED 22W P3241 (WB I & WD schedule P-113, I- 5:3 F.22)	Nos	4	460.02	1840.08	ADD DISTRICT CHARGES 2%
9	Fixing only single/twin fluroscent light fitting complete with all accessories directly on wall/ceiling by screws etc.. [PWD Schedule Page No-C-2;Item No-14a]	Nos	4	90.30	361.20	ADD DISTRICT CHARGES(5%)
10	Supply & fixing Bulk head light fittings with die cast aluminium housing frosted/clear glass on wall/ceiling incl S/F 9 watt LED Lamp complete set. [Make - Havells] (PWD sch - Page--D-13, I-23)	Nos	6	682.95	4097.70	ADD DISTRICT CHARGES(5%)

11	<p>Supply & fixing smart bright street light complete with all accessories to be fixed from the wall of building or on pole incl. making holes /providing clamping arrangement & necy. GI reducer as required.S&F 40 mm GI Pipe 1.5 mtr average length & s&f necy length of 1.5 sqmm pvc insulated single core copper wire & making connections as required & mending good damages incl wall painting. (30 Watt) (Make - Bajaj) [WB I&WD sch P-111, I-f.9.0.2]</p>	Nos	1	3076.32	3076.32	ADD DISTRICT CHARGES 2%
12	<p>Supply of 9" domestic metal exhaust fan 9" (225mm)SWEEP. TRANS AIR - (Make-Crompton/Havells/Bajaj) (UD & MA schedule P-14, I-5)</p>	Nos	4	1863.00	7452.00	NO DISTRICT CHARGES
13	<p>Fixing only exhaust fan after making hole in wall and making good damages and smooth cement finish etc. as practicable as possible and providing necy. length of PVC insulated wire and making connection for exhaust of following diameter: 22.5 cm (9") [PWD Schedule Page No-C-4;Iteam No-28(b)]</p>	Nos	4	259.35	1037.40	ADD DISTRICT CHARGES(5%)
14	<p>Fixing only louver shutter/cowl on wall with necy. bolts & nuts (6 mm dia x 62 mm long) For 22.5 cm(9") Exhaust fan [PWD Schedule Page No-C-4;Iteam No-30(b)]</p>	Nos	4	86.10	344.40	ADD DISTRICT CHARGES(5%)
15	<p>Supply of 240V A.C Ceiling Fan (48" sweep,1200 mm complete) [Make-Crompton [for counter only] (UD & MA schedule P- 23, I- 70)</p>	Each	1	2283.00	2283.00	NO DISTRICT CHARGES
16	<p>Fixing only Ceiling Fan [PWD sch P- C-3, I-21(a)]</p>	Each	1	69.30	69.30	ADD DISTRICT CHARGES(5%)

17	Supply & Fixing 240 V, 16/20 A Piano key type switch (Brand approved by EIC) on sheet metal switch board incl. S & F 100x100x65mm MS (16SWG) switch board and bakelite/perspex top cover of 3mm thick by Brass screws after making housing for switch by cutting bakelite/perspex cover and making necessary connections as required. (For Hand Dryer machine) [PWD sch P- E-6, I-17(b)]	Each	2	211.05	422.10	ADD DISTRICT CHARGES(5%)
18	S/F 240V 25A Modular type starter (brand approved by EIC)with 25 A. Modular switch DP MCB (C-Curve)and 4 Module G.I. Modular type switch board with 4 Module Top Cover Plate flushed in wall incl. S/F switch board and Cover Plate and making necy. Connections with PVC Copper wire and earth connectivity wire etc. as per schedule [for Pump] - [PWD Schedule Page No-E-19, Item No-17] (Please follow in details)	Nos	1	823.20	823.20	ADD DISTRICT CHARGES(5%)
19	Supply and Fixing of 2 mm Polyvinyl glow sign board made of 22 SWG GI sheet box with 1"X1" aluminum channel for fixing the vinyl board after necessary cutting the letter as required & s/f LED tube light fittings along with all accessories. (16 sqft @495.00/sqft) (UD & MA schedule P-14, I-4)	Nos	1	7920.00	7920.00	NO DISTRICT CHARGES
20	Earthing installation by GI earth Spike (1830 X 20 mm) including 8SWG GI EarthWire & GI nuts, bolts, washer etc.	Nos	1	450.00	450.00	NO DISTRICT CHARGES
Total					50963.60	
Add 18% GST					9173.45	
Total With GST (A)					60137.05	
Cess@1%					601.37	
total					60738.42	
Contingency Amount on "A"					1804.11	
(Total+GST)=Rs:					62542.53	
Say Rs.					62543.00	
Rupees Sixty Two Thousand Five Hundred Fourty Three Only						
Service Connection Charges as per Quotation						

Say Rs. 62,543.00

13/5
2025

Sub-Assistant Engineer
SAINTHIA MUNICIPALITY
Sainthia, Birbhum

Chairman
SAINTHIA MUNICIPALITY
Sainthia, Birbhum

P.T.O

BF. RS. 62,543.00

Technically Vetted Rs.: 62,543.00

(Rupees Sixty Two Thousand Five Hundred and forty three only.)

30-05-25
Junior Engineer
Electrical & Mechanical Division
SUDA

Assistant Engineer
ELECTRICAL & MECHANICAL DIVISION
SUDA

26/5/25
Executive Engineer (E/M)
O/O the Secretary M.E. Dte.
Government of West Bengal

62,543.00

Stamp and signature area at the bottom left.

MODEL DRAWING FOR CONSTRUCTION OF C. T./P.T.
TOILET SEATS 4 Nos URINAL 5 Nos
MODEL NO.- G

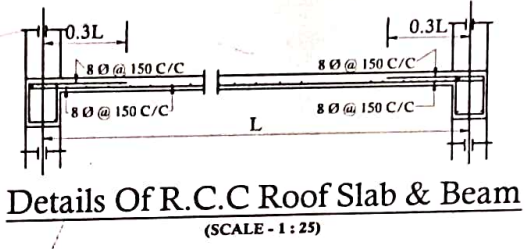
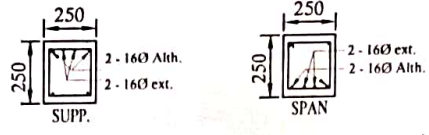
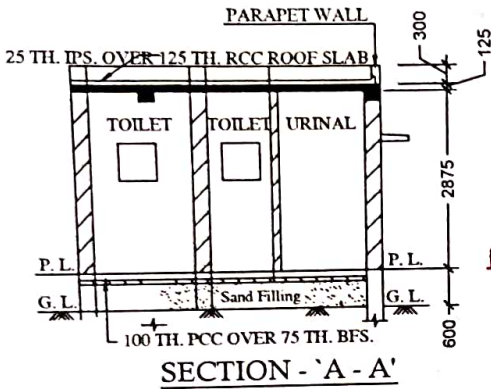
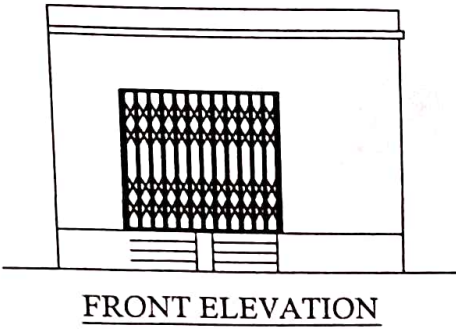

BHLP → 06
TL → 04
EF → 04
OL → 01
CF → 01
GSB → 01

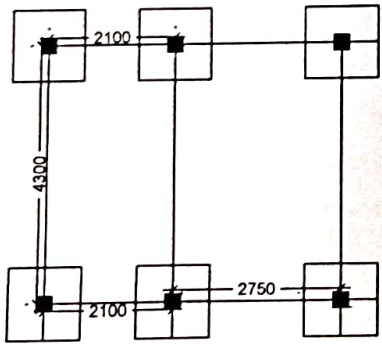
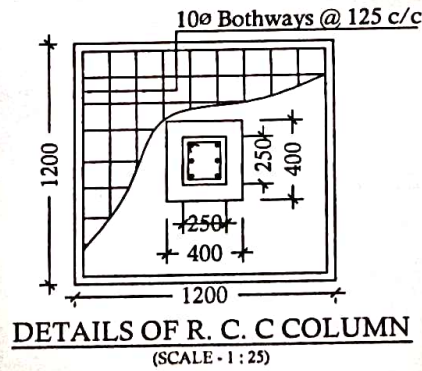
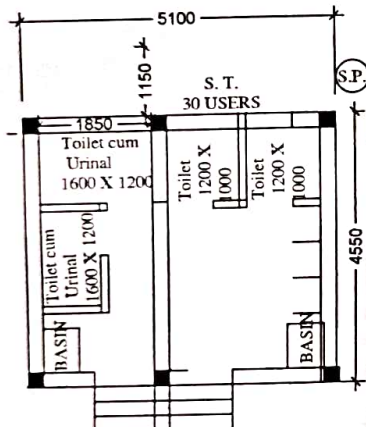
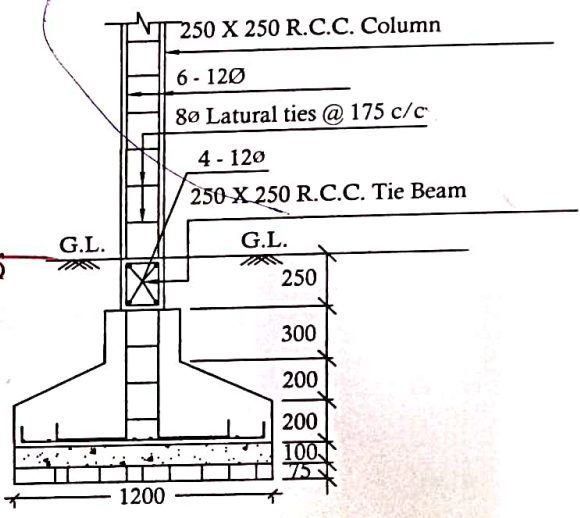

13/5/2025
Sub-Assistant Engineer
SAINTHIA MUNICIPALITY
Sainthia, Birbhum
Chairman
SAINTHIA MUNICIPALITY
Sainthia, Birbhum