

Sl. No.	Item Description & Item No.	Quantity	Rate	Unit	Amount
---------	-----------------------------	----------	------	------	--------

**NON SCHEDULE WORKS**  
**CONSTRUCTION OF 2 NOS. TOILET BLOCK AT KANTADANGA NORTH JANTA ARYA VIDHYALAYA (H.S.) IN WARD NO. 07 UNDER BHATPARA MUNICIPALITY, NORTH 24 PARGANAS**  
**( CT/PT) MODEL NO - F CIVIL WORKS**  
**TOILET SEATS - 2 NOS AND URINAL - 3 NOS**

**PART-B**

Sl. No.	Item Description & Item No.	Quantity	Unit	Rate (Including GST)	Amount
1	Standard plastic Dustbin ( 12 lits )	5	Each	350.00	1,750.00
2	Installation of Sinage	1	Each	2,071.00	2,071.00
3	Air Freshner ( Pack of 4 nos )	8	Each	216.00	1,728.00
4	Air Freshner ( Napthaline 250 gm )	5	Each	210.00	1,050.00
5	Supplying paper Napkin	5	Each	50.00	250.00
6	Supplying Sanitary Napkin (Whisper or similai make 50pcs )	4	Each	520.00	2,080.00
7	Harpic ( Blue 500 ml)	4	Each	300.00	1,200.00
8	Harpic ( Red 500 ml)	4	Each	150.00	600.00
9	Gala double lip floor wiper	4	Each	350.00	1,400.00
10	Colin glass or surface cleaner	2	Lit	200.00	400.00
11	Muriatic Acid	2	Lit	145.00	290.00
12	Bleaching Powder	4	Kg	120.00	480.00
13	Detto!, Lifebuy or similar make liquid soap	8	Lit	140.00	1,120.00
14	Rubber hand Gloves	6	Pair	80.00	480.00
15	Double Side plastic brush	6	Each	125.00	750.00
16	Plastic Broom	4	Each	170.00	680.00
17	Signage ACP Base & reflective vinyl (E8)	1	Each	3,776.00	3,776.00
18	SPS/any other ICT based feedback system (with number displayed on which SMS has to be sent) (A9)	1	Each	5,000.00	5,000.00
19	Glow sign board Name and contact details of the following are displayed prominently - Toilet identification number, name of ULB under whose jurisdiction toilet is covered, ward number and maintenance authority prominently displayed for each toilet block Supervisor, Supervisor's agency and area Sanitary Inspector (D3)	1	Each	5,000.00	5,000.00
20	Mini Tulu pump	1	Each	4,000.00	4,000.00
21	Supplying and fixing sinage with fixing stand post for public toilet for visible to passersby	5	Each	1,000.00	5,000.00

Item Description & Item No.	Quantity	Rate	Unit	Amount
22 Supplying roaster/register for keeping account of regular cleaning (D1)	1	Each	200.00	200.00
23 Lettering on toilet wall for display of name and contact details of ULB, Ward number and name of maintenance authority, sanitary inspector, etc (D3)	1	Each	1,000.00	1,000.00
Sub Total Rs. (PART-B)				40,305.00
Add L.W.C. @ 1%				403.05
Add Contingency @ 3%				1,209.15
Grand Total Amount Rs.				41,917.20
Say Rs.				41,917.0
<b>Rupees forty one thousand nine hundred seventeen only</b>				
For 02 Nos. Toilet Block	41917 X 2		83834.00	
PART-A			Rs. 13,87,756.00	
PART-B			Rs. 83,834.00	
Grand Total Rs.			14,71,590.00	
<b>Rupees Fourteen lakh Seventy One thousand Five Hundred Ninty only</b>				

  
**MITHUN KUMAR DAS**  
 Sub-Asst. Engineer (Civil)  
 Bhatpara Municipality

  
 Assistant Engineer  
 Bhatpara Municipality

  
 Chairperson  
 Bhatpara Municipality

**Necessary NOC should be taken from  
 respective land owner for public use  
 of C.T. / P.T.**

**Excess Expenditure if any from  
 approved cost should be born by ULB**

**VETTED**

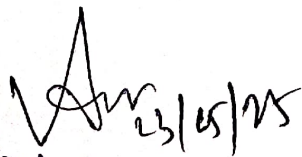
  
 Junior Engineer (Civil)  
 North 24-Parganas Division, M.E. Dte.  
 Deptt. of U.D & M.A  
 Govt. of West Bengal

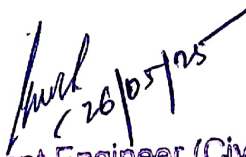
  
 Assistant Engineer (Civil)  
 North 24 Parganas Division  
 Municipal Engineering Directorate  
 Deptt. of U.D. & M.A.  
 Government of West Bengal

Executive Engineer  
 North 24-Parganas Division, M.E. Dte.  
 Deptt. of U D & M.A  
 Govt. of West Bengal

MODLE DRAWING FOR TOILET BLOCK & URINAL AT  
KANTADANGA NORTH JANTA ARYA VIDYALAYA (H.S.) IN  
WARD NO - 07, UNDER BHATPARA MUNICIPALITY ,  
NORTH 24 PARGANAS.

(CT/PT) MODLE NO.- F

TOILET SEATS 2 NOS & URINAL 3 NOS

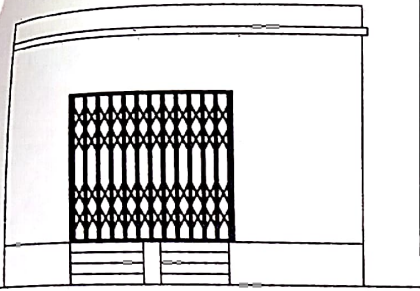

FRONT ELEVATION

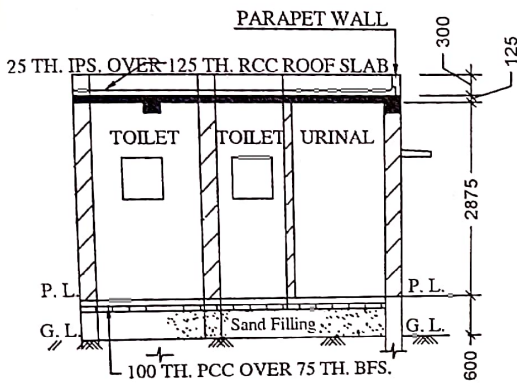

SECTION - 'A - A'

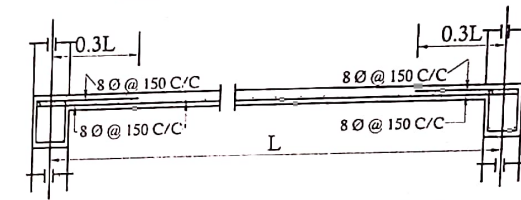
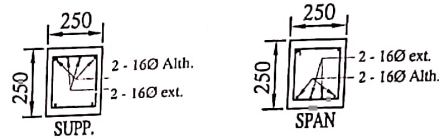

Details Of R.C.C Roof Slab & Beam

(SCALE - 1 : 25)

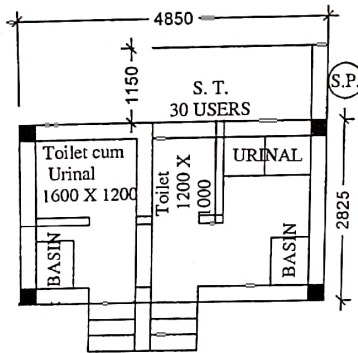

PLAN

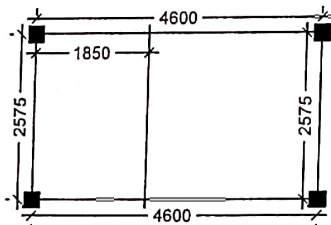

LAYOUT PLAN

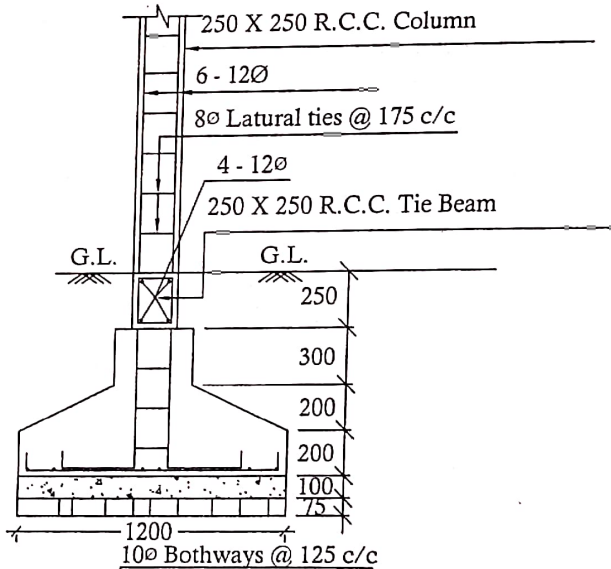

DETAILS OF R. C. C COLUMN

(SCALE - 1 : 25)

*Mithun Kumar Das*  
MITHUN KUMAR DAS  
Sub-Asst. Engineer (Civil)  
Bhatpara Municipality

*Assistant Engineer*  
Assistant Engineer  
Bhatpara Municipality

*Chairperson*  
Chairperson  
Bhatpara Municipality