

**CONSTRUCTION OF COMMUNITY TOILET (CT/PT) AT NORTH BOOK COOLIE
GATE(PART 1) IN WARD NO 09 UNDER CHAMPDANY MUNICIPALITY MODEL NO - G NON
SCHEDULE WORKS**

SL.NO	Item Description & Item No.	Quantity	Rate	Unit	Ammount
1	Non Shedule Item Sl. No. 91-106 (Order as per SUDA) standard plastic dustbin (12lits)	5	350	Each	1750.00
2	Sinage APC based & Reflective vinyl	5	3776	each	18880.00
3	Supplying and fixing sinage with fixing stand post for public toilet for visible to passersby	5	1000	Each	5000.00
4	Glow Sign board Name and contact details of the following are displayed prominently - Toilet Identification number , name of ULB under which jurisdiction toilet is coverwd , ward number and maintanance authority prominently displayed for each toilet block supervisor, supervisor's agency and area sanitary inspector	1	5000	each	5000.00
5	Installation of Sinage	1	2071	each	2071.00
6	Air freshner(pack of 4nos)	8	216	Each	1728.00
7	Air freshner (Napthaline 250 gm)	5	210	Each	1050.00
8	Supplying paper Napkin	5	50	Each	250.00
9	Supplying Sanitary Napkin (Whisper or similar make 50 pcs)	4	520	Each	2080.00
10	Harpic (blue 500 ml)	4	300	Each	1200.00
11	Harpic (Red 500 ml)	4	150	Each	600.00
12	Gala double lip floor wiper	4	350	Each	1400.00
13	Colin glass or surface cleaner	2	200	Lit	400.00
14	Muriatic Acid	2	145	Lit	290.00
15	Bleaching powder	4	120	Kg	480.00
16	Dettol ,lifeboy or similar make liquid soap	8	140	Lit	1120.00
17	Rubber hand gloves	6	80	Pair	480.00
18	Double side plastic brush	6	125	Each	750.00
19	Plastic Broom	4	170	Each	680.00
20	SMS/any otherICT based feedback system (With number displayed on which SMS has to be sent)	1	5000	each	5000.00
21	Mini Tulu Pump	1	4000	each	4000.00
22	supplying roaster /register for keeping account of regular cleanig	3	200	Each	600.00

23	Lettering on Toilet Wall for display of name and contact details of ULB ward number and name of maintenance authority, saniinspector, etc.	1	1000	each	1000.00
				Rs.	55809.00
	Add for Labour welfare Cess @ 1 %			Rs.	558.00
			Total	Rs.	56367.00
	Add for Contingency @ 3 %			Rs.	1674.00
			TOTAL	Rs.	58041.00

Assistant Engineer
Champdany Municipality

Chairman
CHAMPDANY MUNICIPALITY

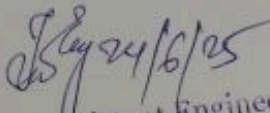

 24/06/25
Junior Engineer (Civil)
 Hooghly Division
 I.E. Directorate, Deptt. of U.D. & M.A.
 Govt. of West Bengal

 24/6/25
Assistant Engineer
 Hooghly Division, M.E. Dte.
 Deptt. of U.D. & M.A.
 Govt. of West Bengal

MODEL DRAWING FOR CONSTRUCTION OF C. T./P.T.
TOILET SEATS 4 Nos URINAL 5 Nos
MODEL NO.- G

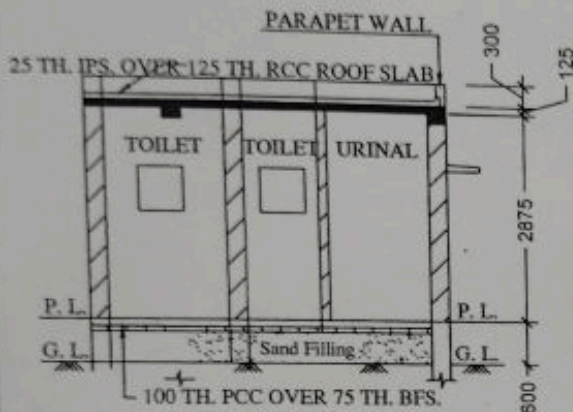

FRONT ELEVATION



SECTION - 'A - A'

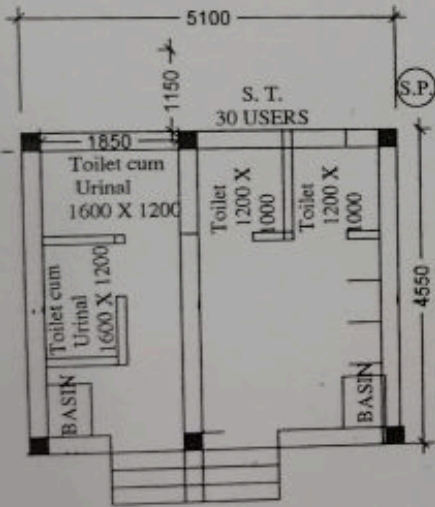

PLAN

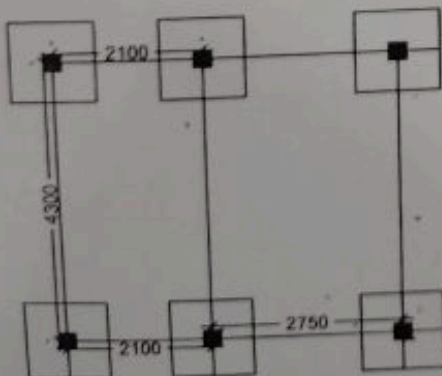

LAYOUT PLAN

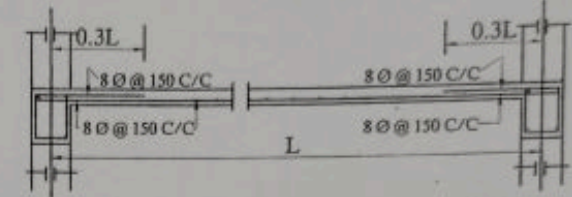
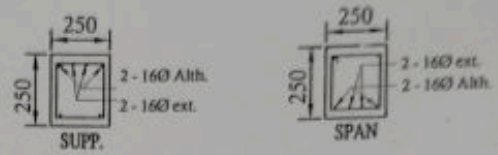

Details Of R.C.C Roof Slab & Beam

(SCALE - 1 : 25)

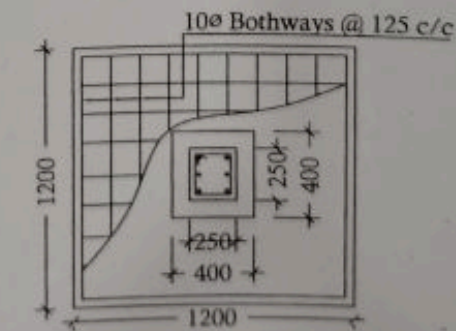
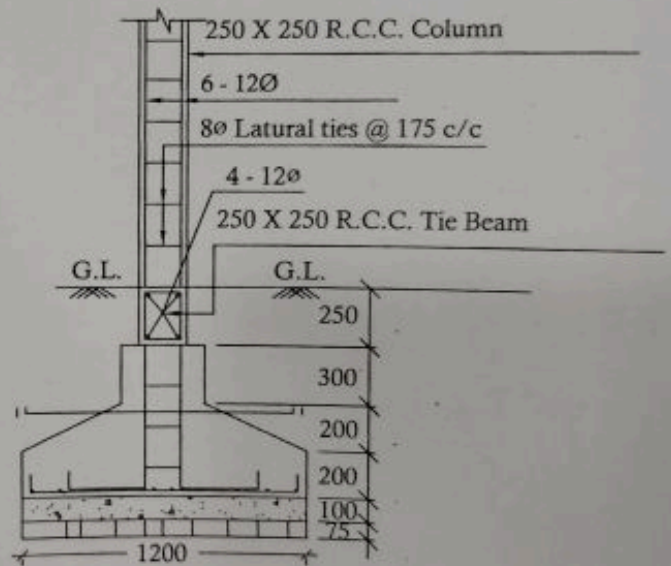

DETAILS OF R. C. C COLUMN

(SCALE - 1 : 25)

Assistant Engineer
Champdany Municipality

Chairman
CHAMPDANY MUNICIPALITY