

**CONSTRUCTION OF TOILET BLOCK ( CT/PT) MODEL NO - E , NON  
SCHEDULE WORKS AT DVC GROUND SITE IN WARD NO 09 UNDER CHAMPDANY  
MUNICIPALITY**

SL.NO	Item Description & Item No.	Quantity	Rate	Unit	Ammount
1	Non Shedule Item Sl. No. 91-106 ( Order as per SUDA) standard plastic dustbin (12lits)	5	350 ✓	Each	1750.00
2	Sinage APC based & Reflective vinyl	5	3776 ✓	each	18880.00
3	Supplying and fixing sinage with fixing stand post for public toilet for visible to passersby	5	1000 ✓	Each	5000.00
4	Glow Sign board Name and contact details of the following are displayed prominently - Toilet Identification number , name of ULB under which jurisdiction toilet is coverwd , ward number and maintanance authority prominently displayed for each toilet block supervisor, supervisor's agency and area sanitary inspector.	1	5000 ✓	each	5000.00
5	Installation of Sinage	1	2071 ✓	each	2071.00
6	Air freshner(pack of 4nos)	8	216 ✓	Each	1728.00
7	Air freshner (Napthaline 250 gm)	5	210 ✓	Each	1050.00
8	Supplying paper Napkin	5	50 ✓	Each	250.00
9	Supplying Sanitary Napkin ( Whisper or similar make 50 pcs )	4	520 ✓	Each	2080.00
10	Harpic (blue 500 ml)	4	300 ✓	Each	1200.00
11	Harpic (Red 500 ml)	4	150 ✓	Each	600.00
12	Gala double lip floor wiper	4	350 ✓	Each	1400.00
13	Colin glass or surface cleaner	2	200 ✓	Lit	400.00
14	Muriatic Acid	2	145 ✓	Lit	290.00
15	Bleaching powder	4	120 ✓	Kg	480.00
16	Dettol ,lifeboy or similar make liquid soap	8	140 ✓	Lit	1120.00
17	Rubber hand gloves	6	80 ✓	Pair	480.00
18	Double side plastic brush	6	125 ✓	Each	750.00
19	Plastic Broom	4	170 ✓	Each	680.00
20	SMS/any otherICT based feedback system ( With number displayed on which SMS has to be sent )	1	5000 ✓	each	5000.00
21	Mini Tulu Pump	1	4000 ✓	each	4000.00
22	supplying roaster /register for keeping acoount of regular cleanig	3	200 ✓	Each	600.00

23	Lettering on Toilet Wall for display of name and contact details of ULB ward number and name of maintenance authority, saniinspector, etc.	1	1000 ✓	each	1000.00
				Rs.	55809.00 ✓
	Add for Labour welfare Cess @ 1 %			Rs.	558.00 ✓
			Total	Rs.	56367.00 ✓
	Add for Contingency @ 3 %			Rs.	1674.00 ✓
			<b>TOTAL</b>	Rs.	<b>58041.00 ✓</b>

  
**Assistant Engineer**  
 Champdany Municipality

  
**Chairman**  
 CHAMPDANY MUNICIPALITY

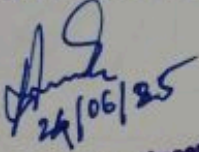
  
 24/06/25  
**Junior Engineer (Civil)**  
 Hooghly Division  
 'E. Directorate, Deptt. of U.D. & M.A.  
 Govt. of West Bengal

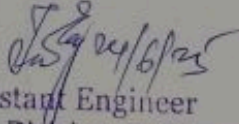
  
 24/6/25  
 Assistant Engineer  
 Hooghly Division, M.E. Dte.  
 Deptt. of U.D. & M.A.  
 Govt. of West Bengal

MODEL DRAWING FOR CONSTRUCTION OF C. T./PT  
TOILET SEAT 7 NOS, URINAL 10 NOS  
MODEL NO.- E

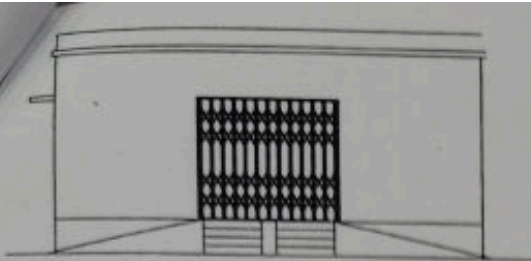

FRONT ELEVATION

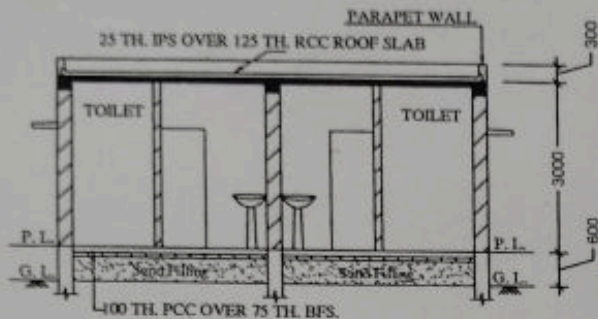

SECTION - 'B - B'

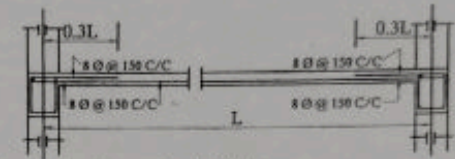
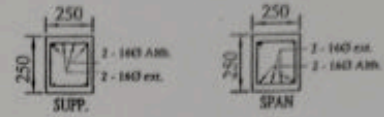

Details Of R.C.C Roof Slab & Beam  
(SCALE - 1 : 25)

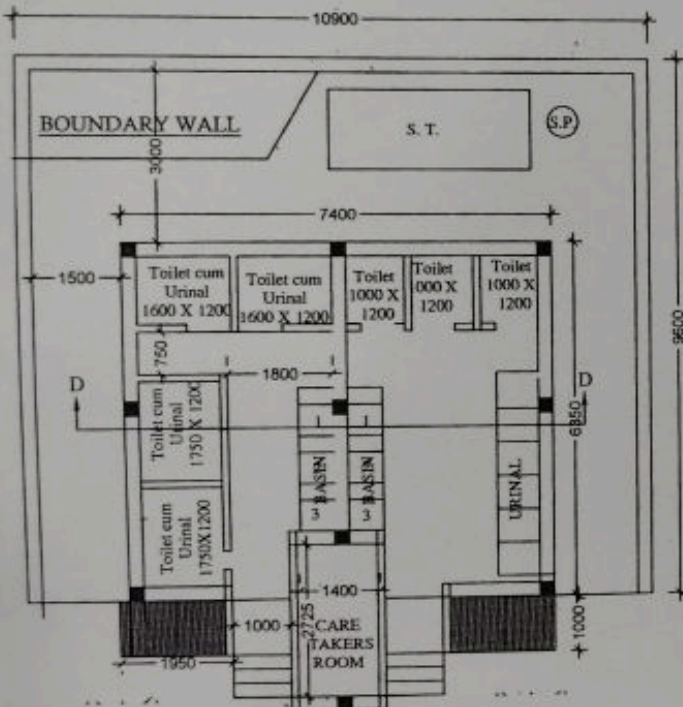

PLAN

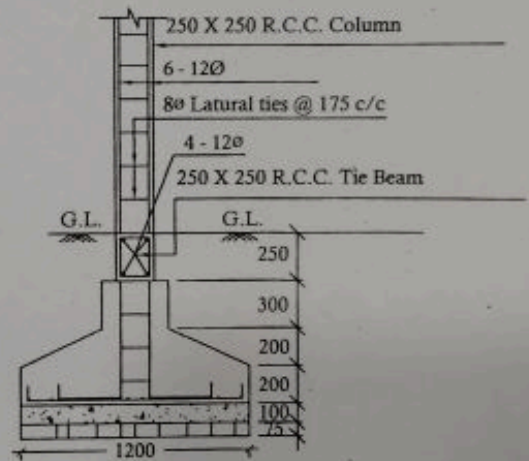

10Ø Bothways @ 125 c/c

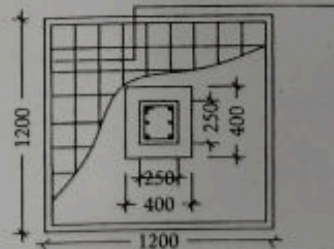

DETAILS OF R.C.C COLUMN  
(SCALE - 1 : 25)

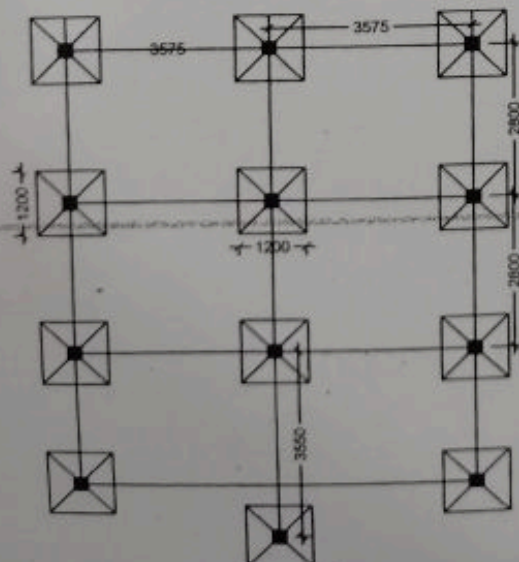

LAYOUT PLAN

Assistant Engineer  
Champdany Municipality,

Chairman  
CHAMPDANY MUNICIPALITY