

CONSTRUCTION OF PUBLIC TOILET (CIVIL WORK) BLOCK AT NEAR UPHC -II BUILDING ,GARULIA MAIN ROAD , WARD NO 10 UNDER GARULIA MUNICIPALITY. (MODEL NO - G) TOILET SEATS -4 NOS AND URINAL- 5 NOS

PART-B

MODEL NO - G TOILET SEATS -4 NOS AND URINAL- 5 NOS

SL. NO.	ITEM DESCRIPTION & ITEM NO.	QUANTITY	RATE	UNIT	AMMOUNT (IN RS.)
1	Standard plastic dustbin (12 lits)	3	350.00	Each	1050.00
2	Installation of Sinage	1	2071.00	Each	2071.00
3	Air freshner (Pack of 4 nos)	9	216.00	Each	1944.00
4	Air freshner (Napthaline 250 gm)	5	210.00	Each	1050.00
5	Supplying paper Napkin	5	50.00	Each	250.00
6	Supplying Sanitary Napkin (Whisper or similar make 50 pcs)	4	520.00	Each	2080.00
7	Harpic (Blue 500 ml)	4	300.00	Each	1200.00
8	Harpic (Red 500 ml)	4	150.00	Each	600.00
9	Gala double lip floor wiper	4	350.00	Each	1400.00
10	Colin glass or surface cleaner	2	200.00	Lit	400.00
11	Muriatic Acid	2	145.00	Lit	290.00
12	Bleaching powder	4	120.00	Kg	480.00
13	Dettol,lifebuy or similar make liquid soap	6	140.00	Lit	840.00
14	Rubber hand Gloves	5	80.00	Pair	400.00
15	Double Side plastic brush	5	125.00	Each	625.00
16	Plastic Broom	4	170.00	Each	680.00
17	Signage ACP Base & reflective vinyl. (E 8)	1	3776.00	Each	3776.00
18	SMS / any other ICT based feedback system (with number displayed on which SMS has to be sent)	1	5000.00	Each	5000.00
19	Glow sign board Name and contact details of the following are displayed prominently - Toilet idetification number, name of ULB under whose jurisdiction toilet is covered, ward number and maintenance authority prominently displayed for each toilet block Supervisor, Supervisor's agency and area Sanitary Inspector.	1	5000.00	Each	5000.00

21	Supplying and fixing sinage with fixing stand post for public toilet for visible to passersby.	2	1000.00	Each	2000.00
22	Supplying roaster /register for keeping account of regular cleanig.	1	200.00	Each	200.00
23	Lettering on toilet wall for display of name and contact details of ULB, Ward number and name of maintanance authority, sanitary, etc	1	1000.00	Each	1000.00
				Rs.	36336.00
				Total Rs.	36336.00
				Say Rs.	36336.00

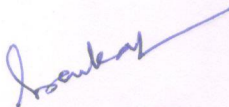

Signature of SAE
Garulia Municipality
 Sub-Assistant Engineer
 Garulia Municipality

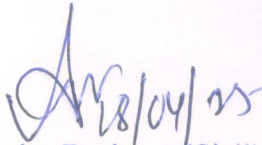
Signature of Chairman
Garulia Municipality
 Chairman
 Garulia Municipality

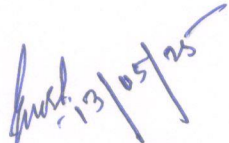

Junior Engineer (Civil)
 North 24-Parganas Division, M.E.Dte.
 Deptt. of U.D & M.A
 Govt. of West Bengal

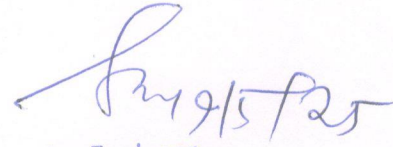
Assistant Engineer (Civil)
 North 24 Parganas Division
 Municipal Engineering Directorate
 Deptt. of U.D. & M.A.
 Government of West Bengal

VETTED

Executive Engineer
 North 24-Parganas Division, M.E.Dte.
 Deptt. of U.D & M.A
 Govt. of West Bengal

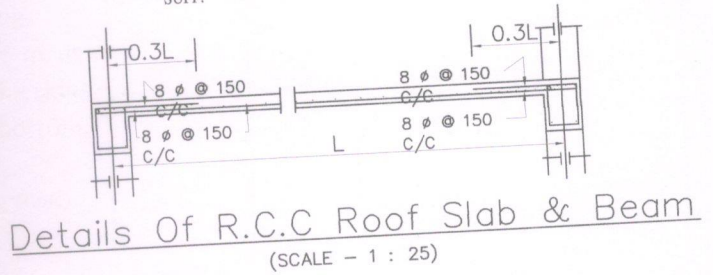
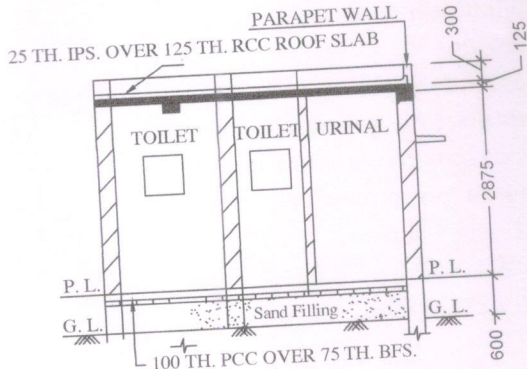
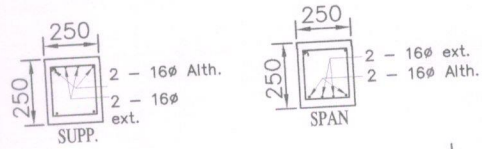
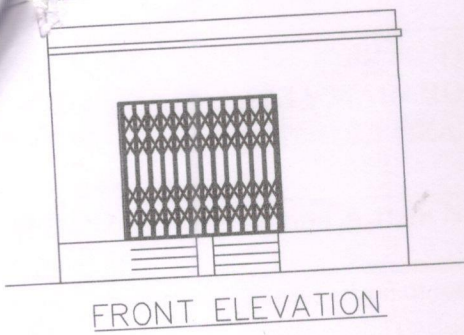
MODEL DRAWING FOR CONSTRUCTION OF C. T.
 TOILET SEATS 4 Nos URINAL 5 Nos
 MODEL NO.- G



SECTION - 'A - A'

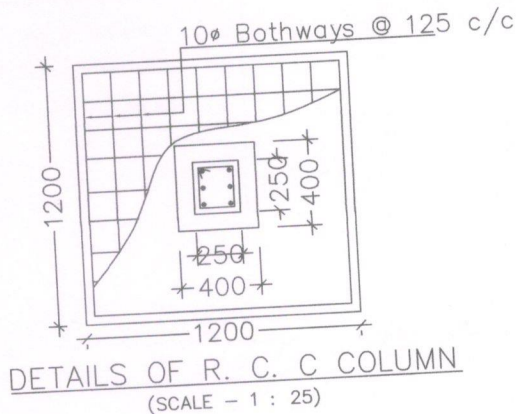
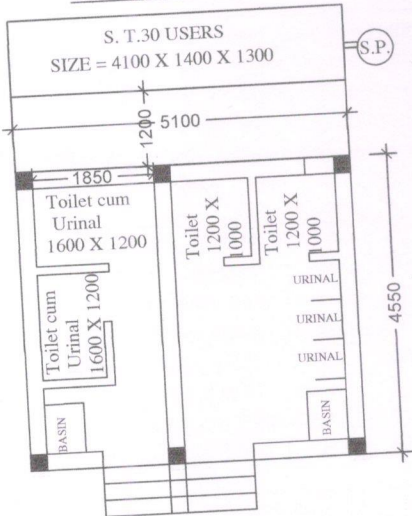
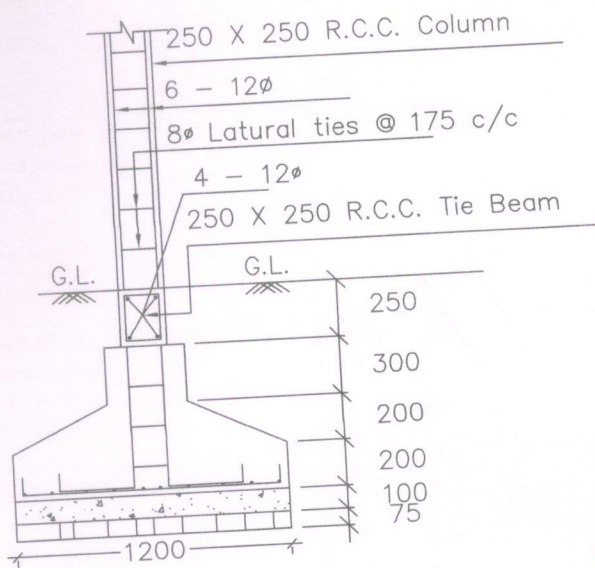

PLAN

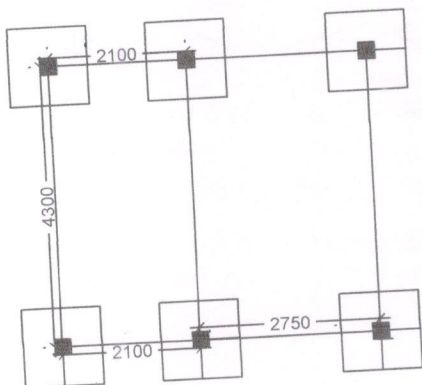

LAYOUT PLAN

[Signature]
 Signature of Chairman.
 Chairman
 Garulia Municipality

[Signature]
 Signature of S.A.E.
 Sub-Assistant Engineer
 Garulia Municipality