

**Annexure-III**  
**Site Inspection Report for construction of CT/PT**

Date: 2-03-01-25

ULB Name	English Bazar Municipality	
Ward No	02	
Name of the proposed site	Police Line Primary School	
Address	English Bazar Ward-02	
Category CT/PT	School PT	
Necessary Land Details	Whether the Land is belongs to the ULB/Other (if Other please specify)	School
	Dag No., Khatian No., J.L. No. & other plot information.	SL No-68, Mouza-Makdumpur Plot No- LR-3078 KH No-05
	No objection Certificate received from the concerned authority	Yes
Nearest location of CT/PT (approx distance in meter)	N/A	
Proposed no of Toilet seats	Male	1
	Female	1
Proposed no of Urinal seats	Male	2
	Female	1
To be constructed as Aspirational Toilet or Normal Toilet (only)	Aspirational/Normal	Normal
Area required for Public Toilets	4 to 5 sq. meters per 10 toilet seats: Min. 1.5 m x 1.2 m	22.5 sqm (Model → F)
Area requirement details in sq mm for Community Toilets	Toilet Cubical (Optimum=900x1200, Minimum=750x900)	
	Urinal (Minimum=500x600)	
Space identified for installation of Soakpit and Soak Well	Yes	
Availability of surface water/piped water supply (in details)	Piped water	
Operation and Maintenance plan in detail	School	
Remarks if any:		
Representative assigned from Hijli Inspiration for the site inspection	Name & Designation	ABHIJIT MAJUMDAR (Eng.)
	Contact No	9851301709
	Signature with Seal	<i>Abhimandar</i> Engineer (Civil) Hijli INSPIRATION
Representative assigned from the ULB for the site inspection	Name & Designation	Pranab Das, S.A.E.(C), E.B.M
	Contact No	8526251702
	Signature with Seal	<i>Pranab R. Das</i> S.A.E. (C) English Bazar Municipality MALDA

English Bazar Municipality  
MALDA



New Toilet  
Police line Prathamik vidyalaya  
24 98911, 88 14584  
X4QW+M94, Subhankar Bandh Rd, Mokdumpur, Malda 732101

MODEL DRAWING FOR CONSTRUCTION OF C. T./P.T.  
TOILET SEATS 2 NOS URINAL 3 NOS  
MODEL NO.- F

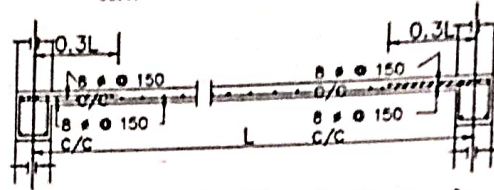
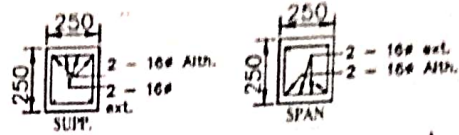

Details Of R.C.C Roof Slab & Beam  
(SCALE - 1 : 25)

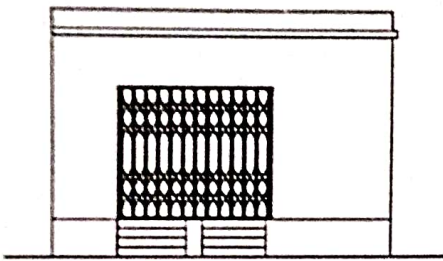

FRONT ELEVATION

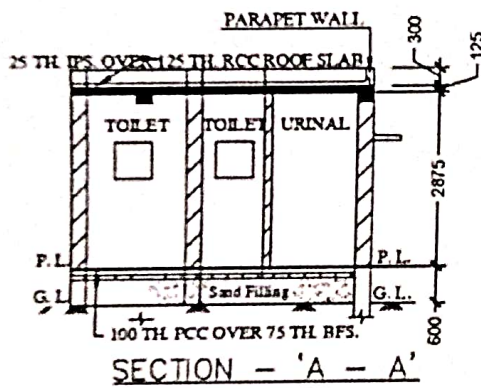

SECTION - 'A - A'

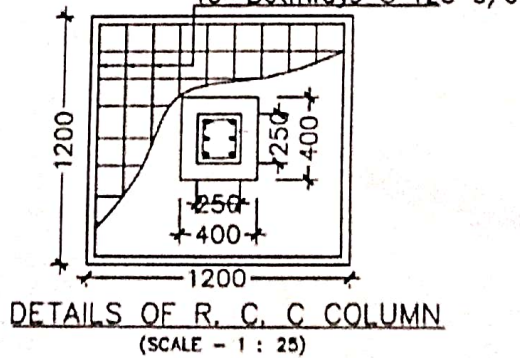
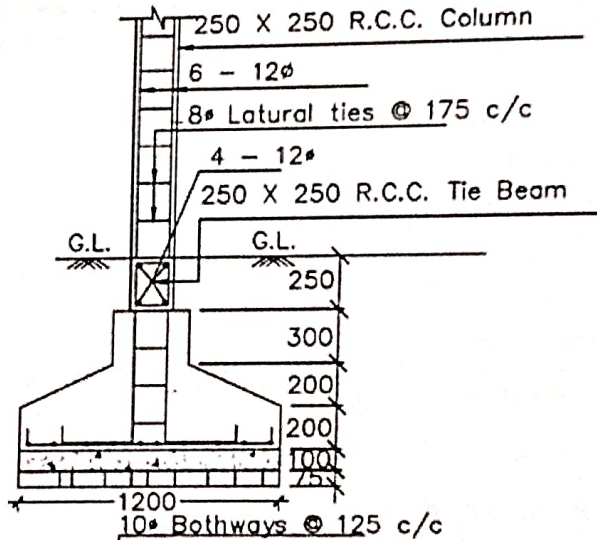
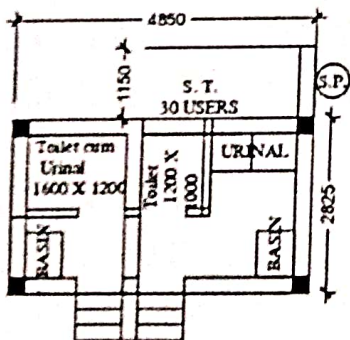

DETAILS OF R. C. C COLUMN  
(SCALE - 1 : 25)

*Pranab. Das*  
S. A. E. (C)  
English Bazar Municipality  
MALDA

# POLICE LINE PRIMARY SCHOOL

ENGLISH BAZAR URBAN CIRCLE

ESTD. - 1976

POLICE LINE • ABHIRAMPUR • PO • MOKDUMPUR • DIST • MALDA • 732101

Ref. No.



Date: 19.11.2024

P. Rabidas S.H.B.(C)

To,  
The Chairman  
English Bazar Municipality,  
Malda

19.11.24  
Chairman.

Subject: NO OBJECTION CERTIFICATE FOR  
CONSTRUCTION OF SCHOOL TOILET IN  
SCHOOL PREMISES

Sir,

On behalf of POLICE LINE PRIMARY SCHOOL authority, the undersigned is going to declare that we have no objection to using premises for construction of school toilet for the beneficial of school students by English Bazar Municipality. The land details of above said school are given below -

- |                         |  |
|-------------------------|--|
| 1. Name of School       | : POLICE LINE PRIMARY SCHOOL           |
| 2. UDISE CODE           | : 19061600202                          |
| 3. Name of Municipality | : ENGLISH BAZAR MUNICIPALITY (WARD: 2) |
| 4. BLOCK                | : ENGLISH BAZAR                        |
| 5. DISTRICT             | : MALDA                                |
| 6. MOUZA                | : MAKDUMPUR                            |
| 7. JL NO                | : 68                                   |
| 8. LR PLOT NO           | : LR 3078                              |
| 9. RS PLOT NO           | :                                      |

Now you are requested to take needful action in the interest of this school.

Copy to:

1. S.P. Malda
2. The Chairman, DPSC Malda
3. The Sub-Inspector of Schools  
E.B. Urban Circle

Kanai ch. Kundu  
Head Teacher  
POLICE LINE PRIMARY SCHOOL  
E.B. Urban Circle, Malda