

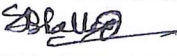

Annexure-III		
Site Inspection Report for construction of CT/PT		
		Date: 2/11/2025
ULB Name	Siliguri Municipal Corporation	
Ward No	1	
Name of the proposed site	Construction of Public Toilet and Urinal at NBSTC bus terminal (back side of Petrol Pump), Ward no.-1 (Unit-2)	
Address	Siliguri Junction	
Category CT/PT	PT	
Necessary Land Details	Whether the Land is belongs to the ULB/Other (If Other please specify)	ULB
	Dag No., Khatian No., J.L. No. & other plot information.	Vested under SMC, 0 khatian land
	No objection Certificate received from the concerned authority (Yes/No)	yes
Nearest location of CT/PT (approx distance in meter)		N/A
Proposed no of Toilet seats	Male	2
	Female	3
Proposed no of Urinal seats	Male	2
	Female	3
To be constructed as Aspirational Toilet or Normal Toilet (only)	Aspirational/Normal	Aspirational
Area required for Public Toilets	4 to 5 sq. meters per 10 toilet seats: Min. 1.5 m x 1.2 m	(7.5m X 7.7m) Model-A
Area requirement details in sq mm for Community Toilets	Toilet Cubical (Optimum=900x1200, Minimum=750x900)	
	Urinal (Minimum=500x600)	
Space identified for installation of Soak pit and Soak Well		Yes
Availability of surface water/piped water supply (in details)		Surface water
Operation and Maintenance plan in detail		ULB by PPP
Remarks if any:	ULB will provide Boaring	
Representative assigned from Hijli Inspiration for the site inspection	Name & Designation	Dibyendu Bhattacharjee (Co-ordinator) & Abhik Majumdar (Civil Engineer)
	Contact No	9932204505 & 9851301709
	Signature with Seal	 
Representative assigned from the ULB for the site inspection	Name & Designation	Sandeep Roy (AE) & Bapi Roy (SAE)
	Contact No	7908519165 & 9434464675
	Signature with Seal	  

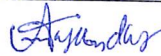





Latitude: 26.723995  
 Longitude: 88.416064  
 Elevation: 141.75±1 m  
 Accuracy: 3.8 m  
 Time: 11-02-2025 12:34  
 Note: NBSTC bus terminal ward no 01

MODEL DRAWING FOR CONSTRUCTION OF C. T./P.  
 Toilet Seats - 5 Nos Urinal 5 Nos  
 MODEL NO.- A

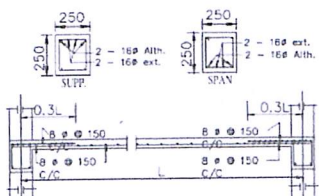
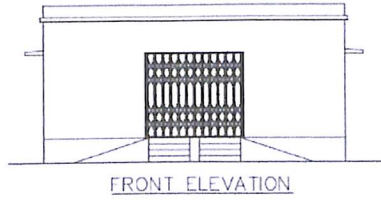

Details Of R.C.C Roof Slab & Beam  
 (SCALE - 1 : 25)

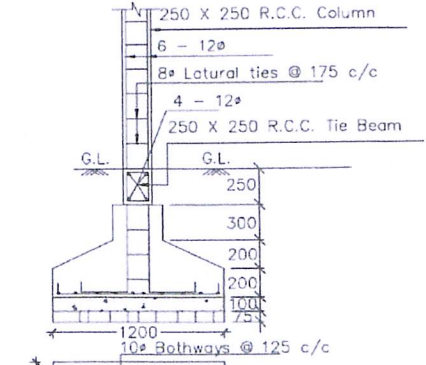
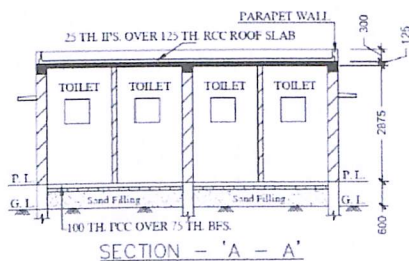

DETAILS OF R. C. C COLUMN  
 (SCALE - 1 : 25)

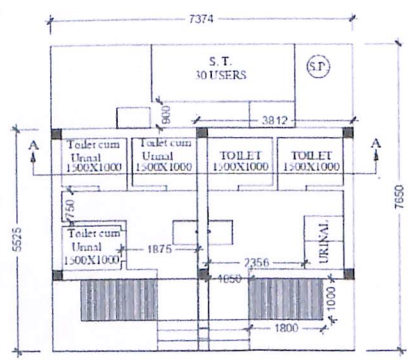

NBSTC bus termina (back side of Petrol Pmump), Ward no.- 1(Unit-2)



# SILIGURI MUNICIPAL CORPORATION

Baghajatin Road, P.O. Siliguri, Dist. Darjeeling, PIN 734001  
Phone : (0353) 2432804, 2435444, 2433277, 2433744, 2526780, 2435282, 2536311  
website : [www.siligurismc.in](http://www.siligurismc.in), E-mail : [silcwb@rediffmail.com](mailto:silcwb@rediffmail.com), [silcwb2@gmail.com](mailto:silcwb2@gmail.com)



Memo No. 06 /NOC/W-1/2024-25

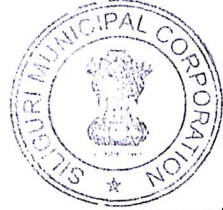

Dated: 20 /02/2025

## SUBMISSION OF N.O.C. REGARDING PUBLIC/COMMUNITY TOILET CONSTRUCTION

This is to inform you that this office has no objection to build a Public Toilet/Community Toilet at the public interest of **Siliguri Junction near NBSTC Bus Terminal, Ward No -01** Maintained by Govt. of West Bengal, under Siliguri Municipal Corporation . The land belongs to vest land and possessed by Siliguri Municipal Corporation. We hereby offering consent in this regard to construct the same.

It is note the said public toilet will be taken care and maintained by the Siliguri Municipal Corporation, Siliguri after completion of construction work of the same.

*Gaugi Chatterjee*  
Chairperson  
Borough Committee No. 1  
Siliguri Municipal Corporation

*Sanjay Pathak*  
SANJAY PATHAK  
Councillor Ward No-01  
Siliguri Municipal Corporation  
Councillor  
Siliguri Municipal Corporation