

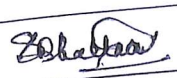
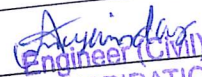

**Annexure-III**  
**Site Inspection Report for construction of CT/PT**

Date: 2/15/2025

**Siliguri Municipal Corporation**

ULB Name	27	
Ward No	27	
Name of the proposed site	Construction of Public Toilet at Jyotsnamoyee Girls' High School, Nerar Deshbandhu Sporting Club ward no-27	
Address	Near 4 no Borough office	
Category CT/PT	PT	
Necessary Land Details	Wheather the Land is belongs to the ULB/Other (If Other please specify)	School Authority
	Dag No., Khatian No., J.L. No. & other plot information.	Plot No- 2756, 2736, JL No- 88, Sheet No.- 10, Mouza- Siliguri Madhya
	No objection Certificate received from the concerned authority (Yes/No)	yes
Nearest location of CT/PT (approx distance in meter)		N/A
Proposed no of Toilet seats	Male	3
	Female	2
Proposed no of Urinal seats	Male	3
	Female	3
To be constructed as Aspirational Toilet or Normal Toilet (only)	Aspirational/Normal	Normal
Area rquired for Public Toilets	4 to 5 sq. meters per 10 toilet seats: Min. 1.5 m x 1.2 m	(7.5m X 7.7m) Model-A
Area requirement details in sq mm for Community Toilets	Toilet Cubical (Optimum=900x1200, Minimum=750x900)	
	Urinal (Minimum=500x600)	
Space identified for installation of Soak pit and Soak Well		Yes
Availability of surface water/piped water supply (in details)		Piped Water
Operation and Maintenance plan in detail		School Committee
Remarks if any:		
Representative assigned from Hijli Inspiration for the site inspection	Name & Designation	Dibyendu Bhattacharjee (Co-ordinator) & Abhik Majumdar (Civil Engineer)
	Contact No	9932204505 & 9851301709
	Signature with Seal	  Sandeep Roy (AE) & Bapi Roy (SAE)
Representative assigned from the ULB for the site inspection	Name & Designation	
	Contact No	7908519165 & 9434464675
	Signature with Seal	   Sub-Assistant Engineer Assistant Engineer Sub-Assistant Engineer

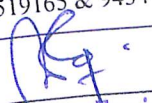
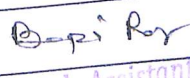



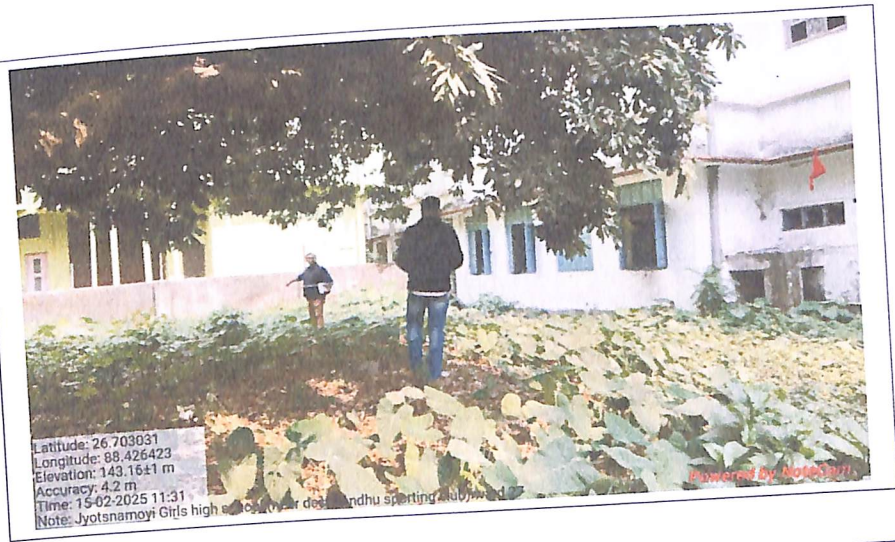

MODEL DRAWING FOR CONSTRUCTION OF C. T./P.T.  
 Toilet Seats - 5 Nos Urinal 5 Nos  
 MODEL NO.- A

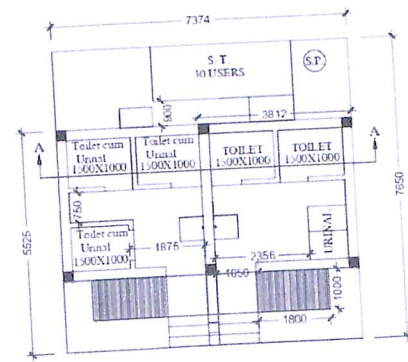
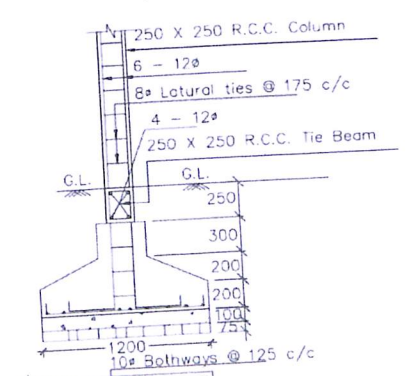
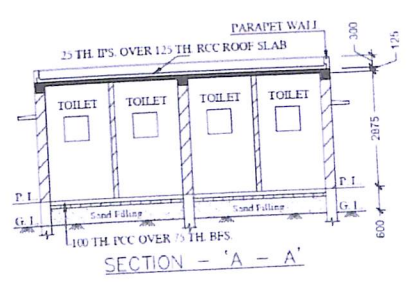
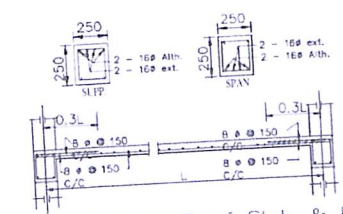
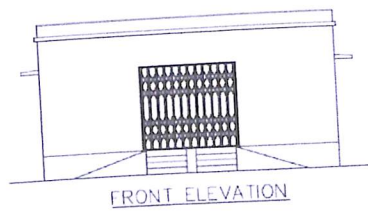

Construction of Public Toilet at Jyotsnamoyee Girls' High School, Nerar Deshbandhu Sporting Club ward no-27

Phone : 0353-2661441

Index No. : S.E.-M4043  
H.S. 07012

**Jyotsnamoyee Girls' High School (H.S.)**  
P.O. SILIGURI TOWN, DIST. DARJEELING, PIN-734004

Date...15/02/25

Ref. No...JS/191/2025

To  
The Mayor,  
Siliguri Municipal Corporation,  
Siliguri, Dist: Darjeeling

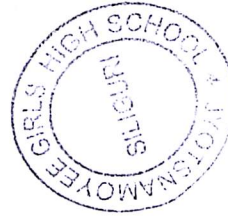

**Subject : N.O.C for the construction of public toilet in Jyotsnamoyee Girls' High School (H.S)**

Respected Sir,

I hope this letter finds you well. I am writing on behalf of the School Management Committee of Jyotsnamoyee Girls' High School (H.S) to inform you that we have no objection to the construction of a public toilet on the specified land in our school.

**The proposed construction site is located at the following land details.**

Mouza : Siliguri Madhya  
J.L No.: 88  
Sheet No. : 10  
Plot No.: 2756, 2736

Our school is committed to providing a hygienic and comfortable environment for our students. The construction of a public toilet is essential to meet this objective and to maintain the highest standards of cleanliness and sanitation.

We assure you that the toilet facility will be maintained regularly to ensure it to remain in good condition in future.

Thanking you,

Yours sincerely

  
15/02/25

Teacher-in-charge  
Jyotsnamoyee Girls' High School  
P.O. Siliguri, Dist. Darjeeling