

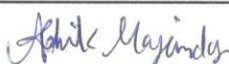

## Annexure-III

## Site Inspection Report for construction of CT/PT

Date : 29.08.2024

ULB Name	MIDNAPORE Municipality	
Ward No	4	
Name of the proposed site	Kusto Colony,Tantigeria,Ward no-4,	
Address	Ward no-4,Tantigeria,Kusto Colony,Midnapur,721101	
Category CT/PT	CT	
Necessary Land Details	Wheater the Land is belongs to the ULB/Other (If Other please specify)	ULB
	Dag No., Khatian No., J.L. No. & other plot information.	Mouza-Tantigeria , J.L NO-151
	No objection Certificate received from the concerned authority	Yes
Nearest location of CT/PT (approx distance in meter)	100M	
Proposed no of Toilet seats	Male	2
	Female	3
Proposed no of Urinal seats	Male	2
	Female	3
To be constructed as Aspirational Toilet or Normal Toilet (only)	Aspirational/Normal	Normal
Area rquired for Public Toilets	4 to 5 sq. meters per 10 toilet seats: Min. 1.5 m x 1.2 m	57.75 Sqm (Model- A)
Area requirement details in sq mm for Community Toilets	Toilet Cubical (Optimum=900x1200, Minimum=750x900)	
	Urinal (Minimum=500x600)	
Space identified for installation of Soakpit and Soak Well	YES	
Availability of surface water/piped water supply (in details)	YES	
Operation and Maintenance plan in detail	community will maintain	
Remarks if any:		
Representative assigned from Hijli Inspiration for the site inspection	Name & Designation	Abhik Majumdar (Engr.)
	Contact No	9851301709 Checked & Verified
	Signature with Seal	
Representative assigned from the ULB for the site inspection	Name & Designation	Engineer (CIVIL) Soumen Das (SAE) INSPIRATION
	Contact No	7384887839
		



Hijli INSPIRATION  
 10.03.2025 8:28  
 22.43497, 87.30745  
 CBMS-P37, Tanjore, Madhavore-72102

MODEL DRAWING FOR CONSTRUCTION OF C. T./P.T.  
 Toilet Seats - 5 Nos Urinal 5 Nos  
 MODEL NO.- A

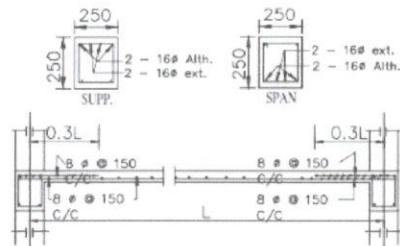
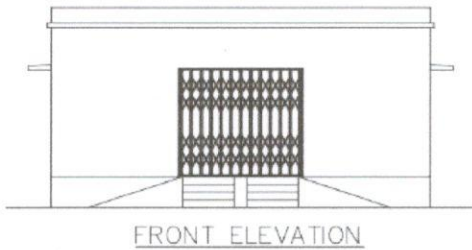

Details Of R.C.C Roof Slab & Beam  
 (SCALE - 1 : 25)

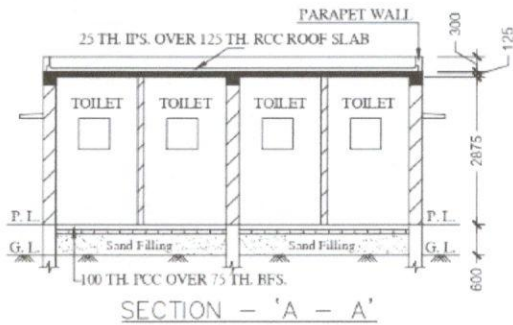

SECTION - 'A - A'

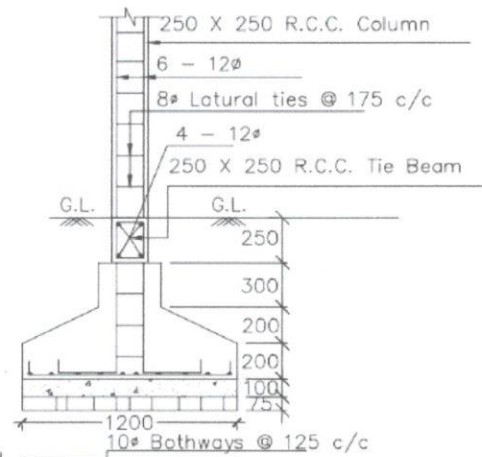
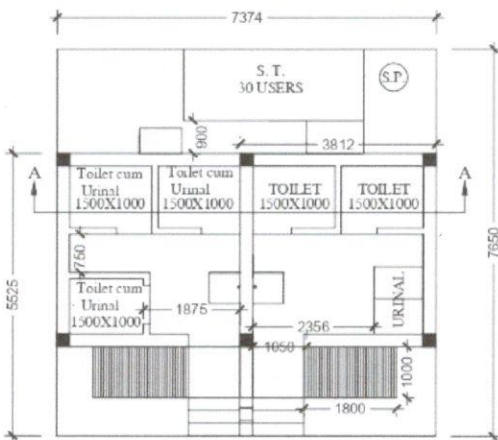

DETAILS OF R. C. C COLUMN  
 (SCALE - 1 : 25)